

HistoCore SPECTRA CV

Coverslipper



Instructions for Use
English

Order No.: 14 0514 80101 - Revision R

Always keep this manual with the instrument.
Read carefully before working with the instrument.

CE

The information, numerical data, notes and value judgments contained in this Instructions for Use represent the current state of scientific knowledge and state-of-the-art technology as we understand it following thorough investigation in this field.

We are under no obligation to update the present Instructions for Use periodically and on an ongoing basis according to the latest technical developments, nor to provide our customers with additional copies, updates etc. of this Instructions for Use.

To the extent permitted in accordance with the national legal system as applicable in each individual case, we shall not be held liable for erroneous statements, drawings, technical illustrations etc. contained in this Instructions for Use. In particular, no liability whatsoever is accepted for any financial loss or consequential damage caused by or related to compliance with statements or other information in this Instructions for Use.

Statements, drawings, illustrations and other information regarding the contents or technical details of the present Instructions for Use are not to be considered warranted characteristics of our products.

These are determined only by the contract provisions agreed between ourselves and our customers.

Leica reserves the right to change technical specifications as well as manufacturing processes without prior notice. Only in this way is it possible to continuously improve the technology and manufacturing techniques used in our products.

This document is protected under copyright laws. All copyrights to this documentation are held by Leica Biosystems Nussloch GmbH.

Any reproduction of text and illustrations (or of any parts thereof) by means of print, photocopy, microfiche, web cam or other methods – including any electronic systems and media – requires express prior permission in writing by Leica Biosystems Nussloch GmbH.

For the instrument serial number and year of manufacture, please refer to the nameplate on the back of the instrument.



Leica Biosystems Nussloch GmbH
Heidelberger Strasse 17 - 19
69226 Nussloch
Germany
Tel.: +49 - (0) 6224 - 143 0
Fax: +49 - (0) 6224 - 143 268
Web: www.LeicaBiosystems.com

Table of contents

1. Important Notes	7
1.1 Symbols and their meanings	7
1.2 Instrument type	11
1.3 User group	11
1.4 Intended purpose	12
1.5 Copyright – Instrument software	12
2. Safety	13
2.1 Safety notes	13
2.2 Hazard warnings	14
2.3 Safety features on the instrument	17
3. Instrument Components and Specifications	18
3.1 Standard delivery – packing list	18
3.2 Technical data	19
3.3 General overview - front view	21
3.4 General overview - rear view	22
3.5 General overview - inside view	23
4. Installation and Instrument Setup	24
4.1 Installation site requirements	24
4.2 Electrical connection	25
4.2.1 Internal battery	26
4.2.2 Using an external uninterruptible power supply (UPS)	26
4.3 Exhaust air connection	27
4.4 Installing the accessories	27
4.4.1 Fit the drawer inserts into the unload drawer	27
4.4.2 Inserting the waste tray	28
4.4.3 Filling and inserting the needle cleaning container	29
4.5 Switching on and shutting down the instrument	30
4.6 Refilling consumables	32
4.6.1 Inserting a coverglass cartridge	33
4.6.2 Inserting the mounting medium bottle and prime bottle	34
4.6.3 Prepare the reagent vessel, fill it and insert it into the load drawer	37
5. Operation	39
5.1 User interface – overview	39
5.1.1 Grayed out function keys	40
5.2 Elements of the status display	41
5.3 Process status display	42
5.4 Consumables Management System (CMS)	43
5.5 Displaying the drawers	44
5.6 Main menu overview	45
5.6.1 Entry keyboard	46
5.7 User settings	48
5.8 Basic settings	50
5.8.1 Language settings	51
5.8.2 Regional settings	51
5.8.3 Date and time	52
5.8.4 Menu for alarm sounds – Error and signal sounds	53







5.8.5	Oven settings.....	55
5.8.6	Volume calibration.....	59
5.8.7	Data management.....	61
5.8.8	Event view.....	64
5.9	Parameter settings.....	66
5.9.1	Creating a new parameter set.....	67
5.9.2	Assigning a parameter set to a rack handle color.....	67
5.9.3	Properties of the mounting medium.....	70
5.9.4	Properties of the coverglass.....	70
5.9.5	Adjustment of the application volume.....	71
5.10	Reagent vessels in the load drawer.....	73
5.11	Module status.....	74
6.	Daily Instrument Setup.....	76
6.1	Station overview.....	76
6.2	Switching on and shutting down the instrument.....	77
6.3	Checking and refilling consumables.....	78
6.3.1	Changing the mounting medium bottle.....	79
6.3.2	Monitoring and refilling of the needle cleaning container.....	82
6.3.3	Checking and replacing the coverglass cartridge.....	83
6.3.4	Emptying the waste tray.....	87
6.3.5	Inspect Pick&Place module.....	87
6.3.6	Load drawer.....	88
6.3.7	Unload drawer.....	89
6.4	Preparing the rack.....	90
6.5	Brief inspection before starting the coverslipping operation.....	93
6.5.1	Procedure of the coverslipping operation.....	93
6.6	Starting the coverslipping operation.....	95
6.6.1	Monitoring the coverslipping operation.....	98
6.6.2	Coverslipping operation finished.....	98
6.6.3	Pausing or canceling the coverslipping operation.....	100
6.7	Workstation operation.....	102
6.7.1	Notes on workstation mode.....	102
6.7.2	Starting the coverslipping operation in workstation mode.....	105
7.	Cleaning and Maintenance.....	106
7.1	Important notes about cleaning this instrument.....	106
7.2	Description of cleaning individual instrument components and areas.....	106
7.2.1	Exterior surfaces, varnished surfaces, instrument hood.....	106
7.2.2	TFT touchscreen.....	107
7.2.3	Load and unload drawers.....	107
7.2.4	Interior cleaning.....	108
7.2.5	Cleaning the prime bottle.....	110
7.2.6	Cleaning the cannulas for the mounting medium bottle.....	110
7.2.7	Cleaning the needle.....	110
7.2.8	Cleaning the shifter.....	112
7.2.9	Filling and changing the needle cleaning container.....	112
7.2.10	Removing the complete unit of the needle cleaning container.....	112
7.2.11	Cleaning the Pick&Place module.....	115
7.2.12	Exchange suction cups.....	116
7.2.13	Cleaning the waste tray.....	117









Table of contents











7.2.14	Cleaning the reagent vessels	117
7.2.15	Rack and handle	117
7.2.16	Changing the active carbon filter.....	118
7.2.17	Cleaning reagent vessels in the load drawer	119
7.3	Preparing the hose system for priming and cleaning.....	119
7.3.1	Quick Prime.....	122
7.3.2	Extended Prime	123
7.3.3	Cleaning the hose system.....	124
7.3.4	Recommissioning after transport or storage.....	128
7.4	Recommended cleaning and maintenance intervals.....	128
7.4.1	Daily cleaning and maintenance.....	128
7.4.2	Weekly cleaning and maintenance	129
7.4.3	Quarterly cleaning and maintenance	130
7.4.4	Cleaning and maintenance as necessary.....	130
8.	Malfunctions and Troubleshooting	131
8.1	Troubleshooting.....	131
8.2	Power failure scenario and instrument failure.....	136
8.3	Manual removal of a rack in the event of instrument malfunctions.....	138
8.3.1	Malfunction at the coverglass receptacle	140
8.3.2	Removing a rack from the elevator of the coverslip line.....	142
8.3.3	Removing the rack from the lower area of the left elevator	147
8.3.4	Removing the rack from the oven or from behind the oven	148
8.3.5	Removal of the rack from the rotator	150
8.3.6	Removal of the rack from the gripper of the transport arm above the rotator	150
8.3.7	Removal of a rack from the transfer station of the HistoCore SPECTRA ST.....	150
8.4	Replacing main fuses.....	152
9.	Optional Accessories and Consumables	153
9.1	Optional accessories	153
10.	Warranty and Service	159
11.	Decommissioning and Disposal	160
12.	Decontamination Certificate.....	161

1. Important Notes

1.1 Symbols and their meanings

Symbol: 	Title of the symbol: Description:	Hazard warning Warnings are displayed in a white field with an orange title bar. Warnings are identified by a warning triangle.
Symbol: 	Title of the symbol: Description:	Note Notes, i.e. important information for the user, are displayed in a white field with a blue title bar. Notes are identified by a notification symbol.
Symbol: → "Fig. 7 - 1"	Title of the symbol: Description:	Item number Item numbers for numbering illustrations. Numbers in red refer to item numbers in illustrations.
Symbol: Supervisor	Title of the symbol: Description:	Software designations Software designations that have to be displayed on the input screen are displayed as bold, gray text.
Symbol: <u>Save</u>	Title of the symbol: Description:	Function key Software symbols that have to be pressed on the input screen are displayed as bold, gray and underlined text.
Symbol: <u>Main switch</u>	Title of the symbol: Description:	Keys and switches on the instrument Keys and switches on the instrument that are supposed to be pressed by the user in various situations are displayed as bold, gray text.
Symbol: 	Title of the symbol: Description:	Attention Indicates the need for the user to consult the instructions for use for important cautionary information such as warnings and precautions that cannot, for a variety of reasons, be presented on the medical device itself.
Symbol: 	Title of the symbol: Description:	Warning, hot surface Instrument surfaces which become hot during operation are marked with this symbol. Avoid direct contact to prevent risk of burning.
Symbol: 	Title of the symbol: Description:	Check display for messages Messages in the display have to be read by the user.
Symbol: 	Title of the symbol: Description:	Manufacturer Indicates the manufacturer of the medical product.

Symbol: 	Title of the symbol: Description:	Date of manufacture Indicates the date when the medical device was manufactured.
Symbol: 	Title of the symbol: Description:	CE Label The CE marking is the manufacturer's declaration that the medical product meets the requirements of the applicable EC directives and regulations.
Symbol: 	Title of the symbol: Description:	UKCA Label The UKCA (UK Conformity Assessed) marking is a new UK product marking that is used for goods being placed on the market in Great Britain (England, Wales and Scotland). It covers most goods which previously required the CE marking.
Symbol: 	Title of the symbol: Description:	CSA Statement (Canada/USA) CSA Mark shown with adjacent indicators 'C' and 'US' for Canada and US (indicating that products have been manufactured to the requirements of both Canadian and U.S. Standards) or with adjacent indicator 'US' for US only or without either indicator for Canada only.
Symbol: 	Title of the symbol: Description:	In vitro diagnostic medical device Indicates a medical device that is intended to be used as an in vitro diagnostic medical device.
Symbol: 	Title of the symbol: Description:	China RoHS Environmental protection symbol of the China ROHS directive. The number in the symbol indicates the "Environment-friendly Use Period" of the product in years. The symbol is used if a substance restricted in China is used in excess of the maximum permitted limit.
Symbol: 	Title of the symbol: Description:	WEEE symbol The WEEE symbol, indicating separate collection for WEEE - Waste of electrical and electronic equipment, consists of the crossed-out wheeled bin (§ 7 ElektroG).
Symbol: 	Title of the symbol:	Alternating current
Symbol: 	Title of the symbol: Description:	Article number Indicates the manufacturer's catalog number so that the medical device can be identified.

Symbol:	Title of the symbol:	Serial number
	Description:	Indicates the manufacturer's serial number so that a specific medical device can be identified.
Symbol:	Title of the symbol:	Consult instructions for use
	Description:	Indicates the need for the user to consult the instructions for use.
Symbol:	Title of the symbol:	UDI
	Description:	Indicates a carrier that contains Unique Device Identifier information. The use of this symbol is optional, but may be used when multiple data carriers are present on the label. If used, this symbol shall be placed adjacent to the Unique Device Identifier carrier. NOTE Used to identify which information is associated with Unique Device Identifier.
 (1)04049188203953		
Symbol:	Title of the symbol:	UK Responsible Person
	Leica Microsystems (UK) Limited Larch House, Woodlands Business Park, Milton Keynes England, United Kingdom, MK146FG	
	Description:	The UK Responsible Person acts on behalf of the non-UK manufacturer to carry out specified tasks in relation to the manufacturer's obligations.
Symbol:	Title of the symbol:	ON (Power)
	Description:	The power supply is connected upon pushing the Power switch .
Symbol:	Title of the symbol:	OFF (Power)
	Description:	The power supply is disconnected upon pushing the Power switch .
Symbol:	Title of the symbol:	Warning, risk of electric shock
	Description:	Instrument surfaces or areas which become energized during operation are marked with this symbol. Therefore, direct contact is to be avoided.
Symbol:	Title of the symbol:	Caution: danger of crushing
		
Symbol:	Title of the symbol:	Flammable
	Description:	Inflammable reagents, solvents and cleaning agents are marked with this symbol.

Symbol:**Title of the symbol:**

Observe the laser beam warning and Instructions for Use

Description:

The product uses a class 1 laser source. The safety notes for handling lasers and the Instructions for Use must be observed.

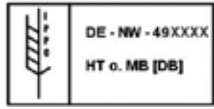
Symbol:**Title of the symbol:**

IPPC symbol

Description:

The IPPC symbol includes:

- IPPC symbol
- Country code in accordance with ISO 3166, e.g. DE for Germany
- Regional identifier, e.g. HE for Hesse
- Registration number, unique number beginning with 49
- Treatment method, e.g. HT (heat treatment)

Symbol:**Title of the symbol:**

Country of Origin

Description:

The Country of Origin box defines the country where the final character transformation of the product has been performed.

Symbol:**Title of the symbol:**

Fragile, use with care

Description:

Indicates a medical device that can be broken or damaged if not handled carefully.

Symbol:**Title of the symbol:**

Store dry

Description:

Indicates a medical device that needs to be protected from moisture.

Symbol:**Title of the symbol:**

Do not stack

Description:

Stacking of the transport package is not allowed and no load should be placed on the transport package.

Symbol:**Title of the symbol:**

This way up

Description:

Indicates correct upright position of the transport package.

Symbol:

Transport temperature range:

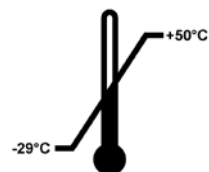
**Title of the symbol:**

Temperature limit for transport

Description:

Indicates the temperature limits for transport to which the medical device can be safely exposed.

Symbol:

Storage temperature range:

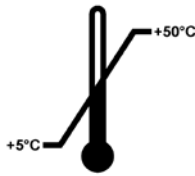

Title of the symbol:

Description:

Temperature limit for storage

Indicates the temperature limits for storage to which the medical device can be safely exposed.

Symbol:



Title of the symbol:

Description:

Humidity limitation for transport and storage

Indicates the range of humidity for transport and storage to which the medical device can be safely exposed.

Appearance:



Indication:

Description:

Tilt indicator

Indicator to monitor whether the shipment has been transported and stored in upright position according to your requirements. With a pitch of 60° or more, the blue quartz sand flows into the arrow-shaped indicator window and sticks there permanently. Improper handling of the shipment is immediately detectable and can be proven definitively.



Note

- When delivering the instrument, the recipient must check that the tilt indicator is intact. The responsible Leica representative must be notified if the indicator has been triggered.
- The Instructions for Use are accompanied by a bound "RFID Registration" supplemental sheet. This supplemental sheet contains country-specific information for the user about the meaning of the RFID symbols and registration numbers available on the packaging or the HistoCore SPECTRA CV nameplate.

1.2 Instrument type

All information provided in these Instructions for Use applies only to the instrument type indicated on the title page. A nameplate indicating the instrument serial number is attached to the rear side of the instrument.

1.3 User group

- The HistoCore SPECTRA CV must only be operated by authorized personnel comprehensively trained in using lab reagents and their application in histology.
- All laboratory personnel designated to operate this instrument must read these Instructions for Use carefully and must be familiar with all technical features of the instrument before attempting to operate it. The instrument is intended for professional use only.

1.4 Intended purpose

The HistoCore SPECTRA CV is an automated coverslipper specifically designed for applying mounting media between a slide and coverglass. Then a coverglass is applied to preserve the specimen and to create a uniform visual surface for microscopic research on histological and cytological tissue samples for medical diagnosis by a pathologist, e.g. for cancer diagnosis.

The HistoCore SPECTRA CV is designed for in vitro diagnostic applications.



Warning

Any use of the instrument that deviates from the intended purpose is considered improper. Failure to adhere to these instructions may result in an accident, personal injury, damage to the instrument or accessory equipment. Proper and intended purpose includes compliance with all inspection and maintenance instructions, along with the observance of all notes in the Instructions for Use as well as the constant inspection of the media being used for storage life and quality.

1.5 Copyright – Instrument software

The software installed and used on the HistoCore SPECTRA CV is subject to the following license agreements:

1. GNU General Public License Version 2.0, 3.0
2. GNU Lesser General Public License 2.1
3. additional software not licensed under the GPL/LGPL

The complete license agreements for the first and second items in the list can be found on the provided language CD (→ [P. 18 – 3.1 Standard delivery – packing list](#)) in the **Software Licenses** directory.

Leica Biosystems provides a complete machine-readable copy of the source code to every third party in compliance with the agreements of the GPL/LGPL applicable for the source code or of the other applicable licenses. To contact us, go to www.leicabiosystems.com and use the corresponding contact form.

2. Safety

2.1 Safety notes



Warning

- The safety and caution notes in this chapter must be observed at all times. Be sure to read these notes even if you are already familiar with the operation and use of other Leica instruments.
- The protective devices located on the instrument and the accessories must not be removed or modified.
- Only qualified service personnel authorized by Leica may repair the instrument and access its internal components.

Residual risks:

- The instrument has been designed and constructed with the latest state-of-the-art technology and according to recognized standards and regulations with regard to safety technology. Operating or handling the instrument incorrectly can place the user or other personnel at risk of injury or death or can cause damage to the instrument or property.
- The instrument may be used only as intended and only if all of its safety features are in proper working condition.
- If malfunctions occur that can impede safety, the instrument must be put out of operation immediately and the responsible Leica service technician must be notified.
- Only original spare parts and approved original Leica accessories may be used.
- Electromagnetic compatibility, emitted interference and immunity to interference are applicable, as are the requirements in accordance with IEC 61326-2-6. The requirements in accordance with IEC 61010-1, IEC 61010-2-101, IEC 62366 and ISO 14971 with regard to safety information are applicable.

These Instructions for Use include important instructions and information related to the operating safety and maintenance of the instrument. The Instructions for Use are an important part of the product, and must be read carefully prior to startup and use and must always be kept near the instrument.



Note

These Instructions for Use must be appropriately supplemented as required by the existing regulations on accident prevention and environmental safety in the operator's country.

The instrument's EC Declaration of Conformity and UKCA Declaration of Conformity can be found on the Internet at:

<http://www.LeicaBiosystems.com>

This instrument has been built and tested in accordance with the safety requirements for electrical equipment for measurement, control, and laboratory use. To maintain this condition and ensure safe operation, the user must observe all notes and warnings contained in these Instructions for Use.

2 Safety



Warning

- The presence of malware on the system can lead to uncontrolled system behavior. Ensuring that the behavior of the instrument conforms to specifications is no longer possible in this case! If the user suspects malware is on the system, the local IT department must be notified immediately.
- You must make sure that any data loaded onto the instrument is free of viruses. No anti-virus software is provided.
- The instrument is only suited for integration in a firewall-protected network. Leica shall not assume any liability for errors due to integration in an unprotected network.
- **ONLY** technicians trained and permitted by Leica can connect a USB input device (mouse/keyboard, etc.) for service and application diagnostics only.

In the interest of specimen safety, the HistoCore SPECTRA CV indicates when it is necessary for the user to intervene using on-screen messages and audible signals. Therefore, the HistoCore SPECTRA CV robotic coverslipper requires that the user is within hearing distance during operation.



Warning

The product uses a class 1 laser source.

Attention, laser radiation! Do not look into the beam! This can cause injury to the retina of the eye.



Warning

LASER RADIATION - DO NOT
STARE INTO BEAM
ISO 60825-1: 2014
P<390 μ W, λ = 630 to 670 nm
Pulse duration = 500 μ s
Class 1 laser product

2.2 Hazard warnings

The safety devices installed in this instrument by the manufacturer only constitute the basis for accident prevention. Operating the instrument safely is, above all, the responsibility of the owner, as well as the designated personnel who operate, service or repair the instrument.

To ensure trouble-free operation of the instrument, make sure to comply with the following notes and warnings.

Please note that electrostatic discharges can result due to direct or indirect contact with the HistoCore SPECTRA CV.



Warning

Markings on the instrument surface showing the warning triangle indicate that the correct operating instructions (as defined in these Instructions for Use) must be followed when operating or replacing the item marked. Failure to adhere to these instructions may lead to accidents causing personal injury and/or damage to the instrument or accessories or destroyed, unusable specimens.

**Warning**

Certain surfaces of the instrument are hot during operation under normal conditions. They are marked with this warning sign. Touching these surfaces without suitable safety measures can cause burns.

Warnings - Transport and installation**Warning**

- The instrument must only be transported in an upright position.
- The empty weight of the instrument is 115 kg; therefore, four qualified persons are required to lift or carry the instrument!
- Use non-skid gloves to lift the instrument!
- A Leica service technician must carry out any transport, installation or possible move of the instrument.
- Retain the instrument packaging.
- Place the instrument on a sturdy laboratory bench which has a sufficient load capacity and adjust it to a horizontal position.
- A Leica service technician must re-level and recalibrate the instrument after any transport.
- Prevent the instrument from being exposed to direct sunlight.
- Only connect the instrument to a grounded power socket. Do not interfere with the grounding function by using an extension cord without a ground wire.
- Exposure to extreme temperature changes between storage and installation locations and high air humidity may cause condensation inside the instrument. If this is the case, wait at least two hours before switching on the instrument.
- The installation of the instrument at the area of use and a possible transport to a new location can only take place with the help of a Leica service technician.
- A Leica service technician must carry out the recommissioning of the instrument.

Warnings – Handling reagents**Warning**

- Caution when handling solvents and mounting media!
- Cover the reagent vessels during instrument pauses to avoid evaporation of the filled reagent. Caution! Reagent vapors (e.g. xylene) can be irritating.
- Always wear protective clothing suitable for laboratory use, as well as rubber gloves and safety goggles when handling the chemicals and mounting medium used in this instrument.
- The installation site must be well-ventilated. In addition, we highly recommend connecting the instrument to an external exhaust air extraction system. The chemicals to be used in the HistoCore SPECTRA CV are flammable and hazardous to health.
- Do not operate the instrument in rooms with an explosion hazard.
- The user is responsible for monitoring the expiration date of other reagents used with the HistoCore SPECTRA CV (e. g. xylene in the reagent vessels and the needle cleaning containers). Expired reagents must be replaced immediately and disposed of. When disposing of consumed, expired or used-up reagents, the applicable local regulations and the waste disposal regulations of the company/institution in which the instrument is being operated have to be observed.
- Reagent vessels must always be filled outside of the instrument in compliance with the safety information.
- Danger of explosion and potential respiratory tract irritation due to flammable, evaporative reagents in the oven.

Warnings – Operating the instrument



Warning

- The instrument may be operated by trained laboratory personnel only. It must only be operated for the purpose of its designated use and according to the instructions contained in these Instructions for Use. Antistatic protective clothing made from natural fibers (e.g. cotton) should be worn when working with the instrument.
- When working with the instrument, wear suitable protective clothing (lab coat, safety goggles and gloves) for protection against reagents.
- In the event of an emergency, shut down the **Main switch** (→ Fig. 1-8) and unplug the instrument from the **Power supply** (→ Fig. 2-2) (circuit breaker in accordance with EN ISO 61010-1).
- For severe instrument faults, the warning and error messages on the screen must be followed. Samples located in the process must be removed from the instrument immediately. The user is responsible for the safe further processing of the samples.
- There is a fire hazard if work with an exposed flame (e.g. Bunsen burner) is carried out in the direct vicinity of the instrument (solvent vapors). Therefore, keep all ignition sources at least 2 meters away from the instrument!
- Be absolutely certain to operate the instrument with the active carbon filter. In addition, we highly recommend connecting the instrument to an external exhaust air extraction system because using the instrument may result in the formation of solvent vapors that are both flammable and hazardous to health, even when the instrument is used according to its intended purpose.
- The user must stay within earshot during the operation in order to react immediately during instrument malfunctions.
- The use of Power over Ethernet (PoE) is not allowed using the RJ45 slot (→ Fig. 2-1) located at the back of the instrument.
- The USB 2.0 slot (→ Fig. 1-7) at the front of the instrument only accepts passive devices (without connection to the power supply, e. g. USB sticks).



Note

For instrument fume control, Leica recommends a delivery volume of 50 m³/h and an 8x air exchange rate (25 m³/m²h) in the lab.



Warning

- Personal protective clothing in the form of a respirator must be worn when working directly with reagent vessels that contain solvents.
- Opening the hood when one or more coverslipping process(es) are active causes delays, since no transport movements take place during this time. Tissue samples might dry out.
- Make sure to keep the instrument cover closed while processing is active. Leica assumes no liability for loss of quality caused by opening the instrument hood during processing.
- **ATTENTION** when closing the hood: Crushing hazard! Do not reach into the swivel range of the hood!
- Liquid must not get behind covers or in gaps while operating or cleaning the instrument.

Warnings - Cleaning and Maintenance



Warning

- The instrument should always be cleaned after the end of work, but **BEFORE** the instrument is shut down. An exception from this is cleaning the interior (→ P. 108 – 7.2.4 Interior cleaning). We recommend cleaning while the instrument is shut down.
- When cleaning the instrument, wear suitable protective clothing (lab coat, cut-resistant gloves and safety goggles) to protect from reagents.
- When using cleaners, please comply with the safety instructions of the manufacturer and the laboratory safety regulations.
- Do not use any of the following for cleaning the outside surfaces of the instrument: alcohol, detergents containing alcohol (glass cleaners), abrasive cleaning powders, solvents containing acetone, ammonia, chlorine, or xylene!
- Clean the hood and housing using mild commercial, pH-neutral household cleaners. The finished surfaces are not resistant to solvents and xylene substitutes!
- The plastic reagent vessels can be cleaned in a dishwasher at a maximum temperature of +65 °C. Any standard cleaning agent for laboratory dishwashers may be used. Never clean the plastic reagent vessels at higher temperatures since higher temperatures can cause the reagent vessels to become deformed.

2.3 Safety features on the instrument



Warning

- Make sure to keep the hood closed whenever coverslipping processes are active. Leica assumes no liability for loss of quality caused by opening the hood during processing.
- If the hood of the instrument is opened, the movements are stopped for safety reasons as soon as the slide currently being coverslipped is finished being coverslipped in order to avoid any risk of specimen damage due to collision with moving parts.
- Opening the hood when one or more coverslipping process(es) is/are active causes delays in the respective processing steps since no transport movements take place for this time frame.
- To ensure smooth operation of the instrument software, the instrument must be restarted by the user at least every 3 days.

3. Instrument Components and Specifications

3.1 Standard delivery – packing list

Qty	Designation	Order No.
1	HistoCore SPECTRA CV basic instrument (local power cord included)	14 0514 54200
4	Rack for 30 slides (3 pcs. per package)	14 0512 52473
1	Handle for rack for 30 slides (yellow, 3 pcs. per package)	14 0512 52476
1	Handle for rack for 30 slides (light blue, 3 pcs. per package)	14 0512 52477
1	Handle for rack for 30 slides (red, 3 pcs. per package)	14 0512 52480
1	Handle for rack for 30 slides (white, 3 pcs. per package)	14 0512 52484
2	Label cover S	14 0512 53748
2	Label cover, blank	14 0512 47323
2	Reagent vessel, assembly, each consisting of 1 pc.:	14 0512 47086
	Reagent vessel	14 0512 47081
	Reagent vessel cover	14 0512 47085
	Reagent vessel handle	14 0512 47084
1	Prime bottle, assembly, consisting of:	14 0514 53931
1	Lab bottle, 150 ml	14 0514 56202
1	Screw cap	14 0478 39993
1	Prime bottle insert	14 0514 57251
1	28x3 mm O-ring	14 0253 39635
1	Cleaning bottle	14 0514 57248
2	Needle cleaning container, kit (2 pcs. per kit, as reserve)	14 0514 54195
3	Rack storage rails for the unload drawer	14 0514 56165
1	Exhaust air hose set, consisting of:	14 0514 54815
1	Exhaust air hose, 2 m	14 0422 31974
1	Hose clamp	14 0422 31973
1	Pair of cut-resistant gloves, size M	14 0340 29011
1	Tool kit HistoCore SPECTRA CV, consisting of:	14 0514 54189
1	Screwdriver, 5.5x150	14 0170 10702
1	Leica brush	14 0183 30751
2	T16A fuse	14 6000 04696
1	Active carbon filter set, consisting of:	14 0512 53772
2	Active carbon filter	14 0512 47131
4	Suction cups (as reserve)	14 3000 00403
2	Waste trays	14 0514 49461
1	International bundle Instructions for Use (incl. English printout and additional languages on a data storage device 14 0514 80200)	14 0514 80001

If the local power cord is defective or lost, please contact your local Leica representative.

**Note**

The delivered components must be carefully compared against the packing list, delivery note, and your order. Should you find any discrepancies, please contact your Leica sales office without delay.

3.2 Technical data

Nominal supply voltages:	100–240 V AC \pm 10 %	
Nominal frequency:	50/60 Hz	
Power draw:	1100 VA	
Fuses:	2 x T16 A H 250 V AC	
IEC 1010 classification:	Protection class 1	
Pollution degree in accordance with IEC61010-1:	2	
Overvoltage category in accordance with IEC61010-1:	II	
Exhaust air:	Hose length:	2000 mm
	Inner diameter:	50 mm
	Outer diameter:	60 mm
	Exhaust performance:	30 m ³ /h
Exhaust extraction:	Active carbon filter and exhaust hose for connecting with an external exhaust system.	
Heat emission:	1100 J/s	
A-weighted noise level, measured at 1 m distance:	< 70 dB (A)	
Connections:		
1 x RJ45 Ethernet (rear):	RJ45 - LAN (external data management)	
1 x RJ45 Ethernet (front):	Only for service purposes	
2 x USB 2.0 (front):	5 V/500 mA (service & data storage)	
International protection class:	IP20	
1st parameter = Protected against fixed foreign bodies with a diameter \geq 12.5 mm		
2nd parameter = No protection against water		
Ambient conditions:		
Operation:	Temperature:	+18 °C to +30 °C
	Relative humidity:	20 % to 80 %, non-condensing
	Operating elevation:	Up to a max. of 2000 m above sea level
Storage:	Temperature:	+5 °C to +50 °C
	Relative humidity:	10 % to 85 %, non-condensing
Transport:	Temperature:	-29 °C to +50 °C
	Relative humidity:	10 % to 85 %, non-condensing

3 Instrument Components and Specifications

HistoCore SPECTRA CV Dimensions and weights:	Dimensions (length x depth x height):	Hood closed: 690 x 785 x 615 mm Hood opened: 690 x 785 x 1060 mm
	Weight, empty (without reagents and accessories):	115 kg
Workstation dimensions and weights (HistoCore SPECTRA CV and HistoCore SPECTRA ST):	Dimensions (length x depth x height):	Hood closed: 2044 x 785 x 615 mm Hood opened: 2044 x 785 x 1060 mm
	Weight, filled (with reagents and accessories):	120 kg
Performance:	Weight, empty (without reagents and accessories):	280 kg
	Weight, filled (with reagents and accessories):	335 kg
Performance:	Usable slides:	In accordance with DIN ISO 8037-1 (76 mm x 26 mm)
	Coverglass cartridge capacity:	Exclusively Leica consumables with 300 coverglasses per magazine
Performance:	Coverglasses:	Exclusively Leica consumables. Available size: 50 mm x 24 mm, thickness: No. 1 In accordance with ISO 8255-1
	Mounting medium application quantity:	Preset value corresponding to coverglass size. Fine adjustment by users possible.
Performance:	Types of mounting media:	Exclusively Leica consumables: X1 mounting medium
	Capacity of mounting medium bottle:	At least 1600 slides
Factory settings:	Racks:	Leica rack for 30 slides
	Mounting medium application volume:	0 (→ P. 59 – 5.8.6 Volume calibration)
Factory settings:	Oven temperature:	40 °C (not changeable)
	Oven step:	Enabled
Factory settings:	Date format:	International (DD.MM.YYYY)
	Time format:	24 h
Factory settings:	Language:	English



Note

When using an external uninterruptible power supply (UPS), it should be designed for an output of at least 1100 VA and ensure operation over a time frame of at least 10 minutes.

3.3 General overview - front view

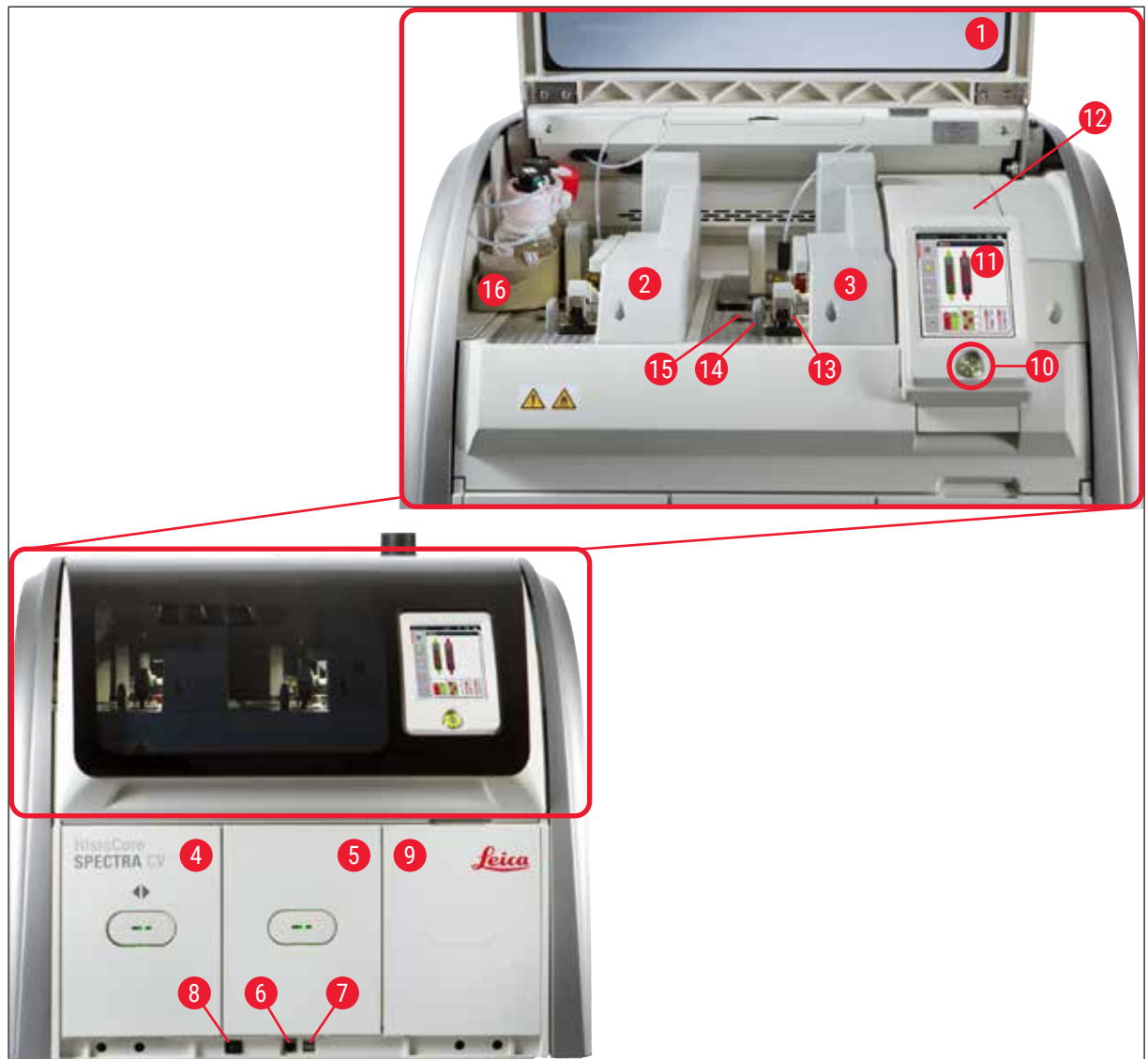

Fig. 1

1	Instrument hood	9	Access to oven
2	Left coverslip line <u>L1</u>	10	Operating switch
3	Right coverslip line <u>L2</u>	11	Screen with user interface
4	Load drawer	12	Fuses
5	Unload drawer	13	Pick&Place module
6	Service access	14	Waste tray
7	USB slot	15	Coverglass cartridge
8	Main switch	16	Bottle sledge

3 Instrument Components and Specifications

3.4 General overview - rear view

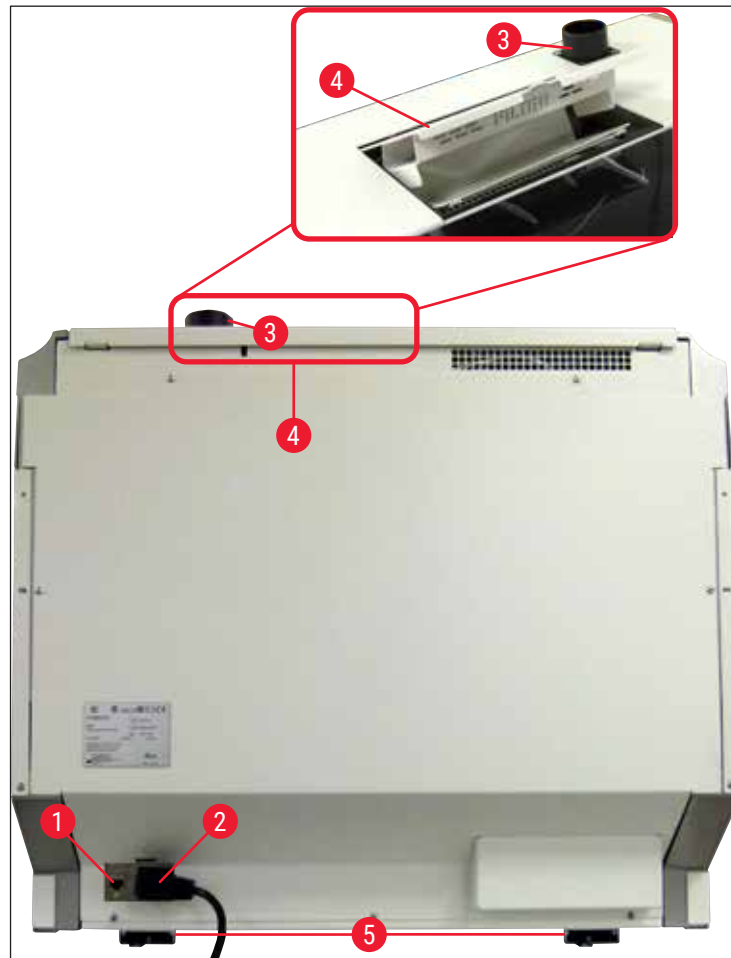

Fig. 2

1 Network connection

2 Power supply

3 Exhaust air connection

4 Access to activated carbon filter

5 Height-adjustable instrument feet

3.5 General overview - inside view

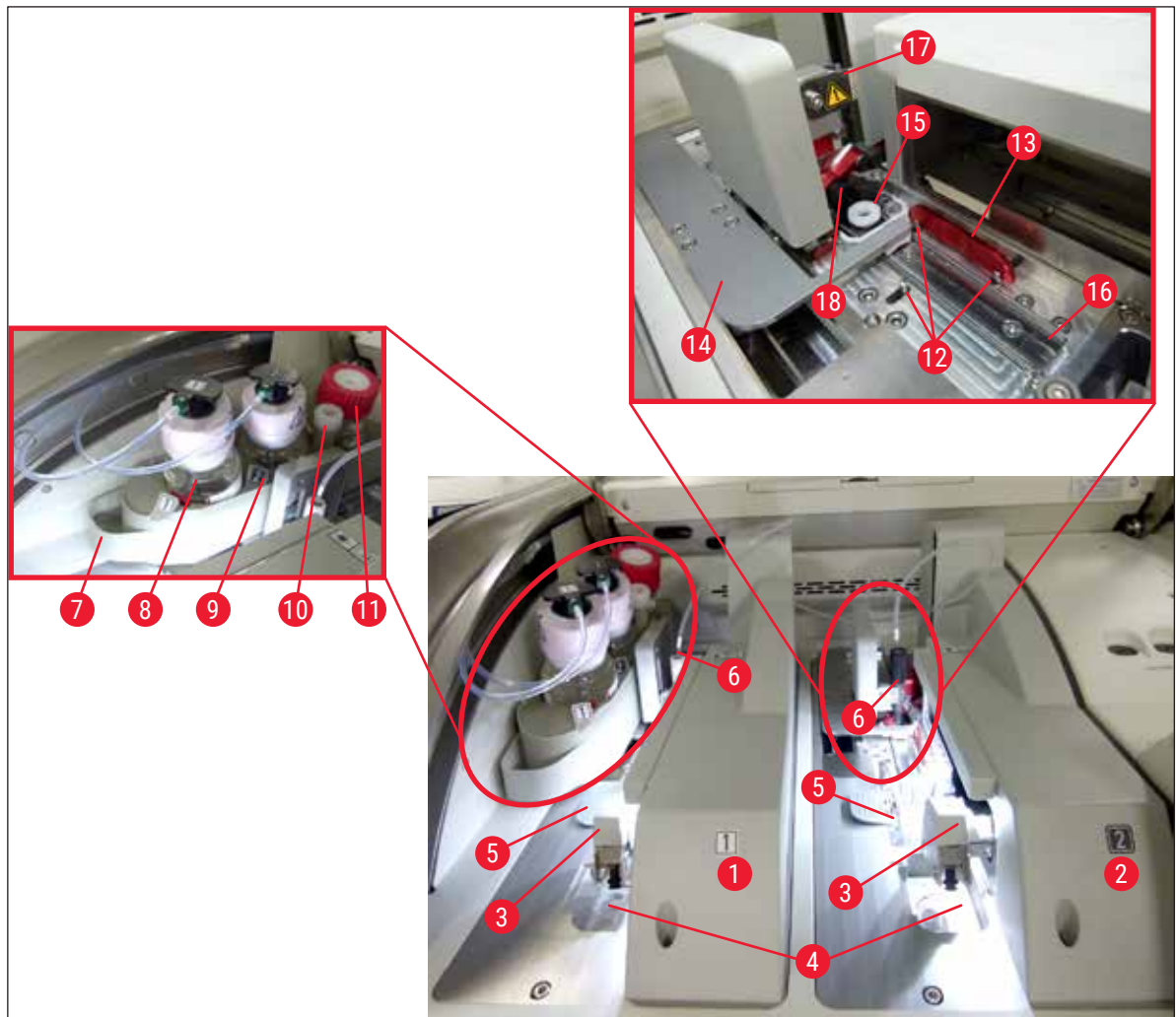

Fig. 3

1	Left coverslip line <u>L1</u>	10	Parking location
2	Right coverslip line <u>L2</u>	11	Prime bottle
3	Pick&Place module	12	Alignment pins
4	Waste tray	13	Red bar
5	Coverglass cartridge	14	Shifter and shifter tongue
6	Needle	15	Needle cleaning container
7	Bottle sledge	16	Coverslipping position of the slide
8	Mounting medium bottle <u>L1</u>	17	Needle holder
9	Mounting medium bottle <u>L2</u>	18	Elevator with locking mechanism

4. Installation and Instrument Setup

4.1 Installation site requirements



Note

- Installation, adjustment and level alignment of the instrument are carried out as part of the instrument installation by a service technician certified by Leica only.
- The level orientation is done using a level and by adjusting the height-adjustable instrument feet (→ Fig. 2-5).
- Use 4 qualified persons when lifting the instrument. Grab under the frame at all corners and lift evenly.



Warning

Failure to level the instrument correctly may result in instrument malfunctions. Slides may slide out of the rack during the necessary transport movements.

- Ensure that there is a vibration-free floor and sufficient clear space (approx. 1.10 m) above the laboratory bench to allow unobstructed opening of the hood.
- It is the user's responsibility to make sure that a compatible electromagnetic environment is maintained so that the instrument can work as intended.
- Condensation water may form in the instrument if there is an extreme difference in temperature between the storage location and the installation site and if air humidity is high at the same time. A waiting time of at least two hours must be observed each time before switching on. Failure to comply with this may cause damage to the instrument.
- Stable, exactly horizontal and level laboratory bench at least 1.00 m wide (2.20 m when operating as a workstation) and 0.80 m deep.
- The counter area must be vibration-free and level.
- Fume hood at a max. 2.0 m distance from the instrument.
- The instrument is suitable for operation in indoor areas only.
- The operating location must be well-ventilated. In addition, an external exhaust air extraction system is highly recommended.
- A grounded power supply socket must be available at a maximum distance of 3 m.
- The power plug must be freely and easily accessible.



Warning

- A connection to an external exhaust system, a technical room ventilation system and an integrated exhaust system with an active carbon filter reduce the concentration of solvent vapor in the room air. The active carbon filter must be used for connecting to an external exhaust system as well (→ P. 118 – 7.2.16 Changing the active carbon filter). Compliance with this is mandatory.
- The instrument operator bears responsibility for complying with workplace limits and the measures necessary for this, including documentation.

4.2 Electrical connection



Warning

- Use only the power cable provided, which is intended for the local power supply.
- Before connecting the instrument to the power supply, make sure that the **Main switch** on the bottom front of the instrument (→ Fig. 1-8) is in the **OFF** ("0") position.

1. Connect the power cable to the power input socket on the rear panel of the instrument (→ Fig. 4-1).
2. Plug the power plug into a grounded power socket.
3. Switch on the **Main switch** (→ Fig. 1-8).



Fig. 4

4. After a short period of time, the **Operating switch** lights up orange. Once the software has finished starting up, the switch lights up red (→ Fig. 5-1) and the instrument is in standby mode.
5. The **Operating switch** can then be operated.



Fig. 5

4 Installation and Instrument Setup

4.2.1 Internal battery

- The HistoCore SPECTRA CV has a high-performance internal battery to bridge short-term power failures (< 3 s.). This enables processing to continue without interruption during a short-term power failure.
- The software detects if the power failure lasts longer than 3 sec. and initiates a controlled shutdown of the instrument (→ P. 136 – 8.2 Power failure scenario and instrument failure).



Note

- The internal battery has to be recharged when initializing the instrument after a power failure. The user is notified of the charging process by a note on the screen. Once the charging process has finished, the information message goes away automatically and the software prompts the user to check if there are any racks still in the instrument and to remove them by hand if necessary. The user confirms the removal of the rack by pressing the **Ok** button. Then the instrument restarts.
- The internal battery has to be charged if the instrument has been disconnected from a power supply for 4 weeks. For this purpose, connect the instrument to the socket and switch on the **Main switch** (→ Fig. 1-8). The charging time is approx. 2 hours.

4.2.2 Using an external uninterruptible power supply (UPS)

An interruption of processing can be avoided in the event of a temporary power failure by connecting a battery-buffered uninterruptible power supply (UPS) (→ Fig. 6-1).

The UPS should enable an output of at least 1100 VA for the duration of 10 minutes.

The UPS must be designed for operating voltage at the installation location. The connection is carried out by connecting the HistoCore SPECTRA CV power cable to the UPS power output socket. The UPS is connected to the power socket in the lab.

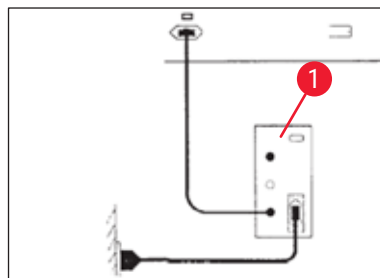

Fig. 6



Warning

The UPS power cable must always remain in the power socket in the lab, even in the event of a power outage. Otherwise grounding of the instrument cannot be ensured!

4.3 Exhaust air connection

- » Connect one end of the exhaust air hose (→ Fig. 7-1) to the exhaust air connection (→ Fig. 2-3) on the top side of the instrument using the hose clamp (→ P. 18 – 3.1 Standard delivery – packing list) included in the standard scope of delivery (→ Fig. 7-2). Connect the other end to an exhaust air device installed at the lab.

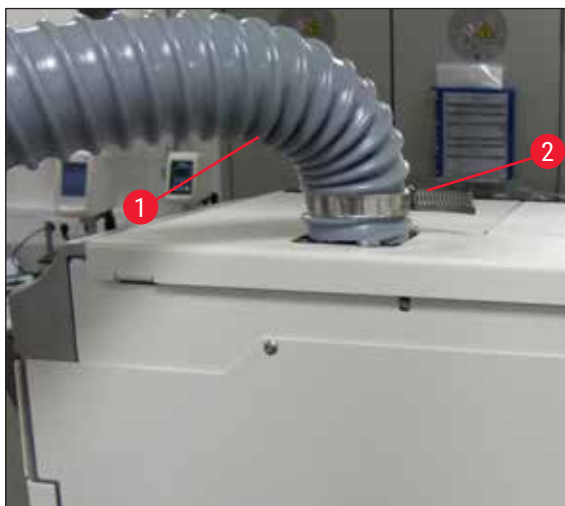

Fig. 7



Warning

- A connection to an external exhaust air extraction system is highly recommended. The active carbon filter must be used to enable the integrated air extraction system to reduce the concentration of solvents in the air.
- The active carbon filter must be used for connecting to an external exhaust system as well (→ P. 118 – 7.2.16 Changing the active carbon filter). Compliance with this is mandatory.
- The owner/operator must verify compliance with the workplace limit values when work is done with hazardous materials.

4.4 Installing the accessories

4.4.1 Fit the drawer inserts into the unload drawer



Note

The load and unload drawers can be manually opened while the system's power is turned off.

1. Manually pull the unload drawer until it stops.
2. For a simplified fitting of the inserts, the unload drawer can be further opened. For this purpose, raise the red retaining lever (→ Fig. 8-3) that moves the unload drawer completely out of the instrument and carefully fold it downwards.
3. Insert the three inserts (→ Fig. 8-1) into the compartments (→ Fig. 8-2) in the unload drawer.

4 Installation and Instrument Setup

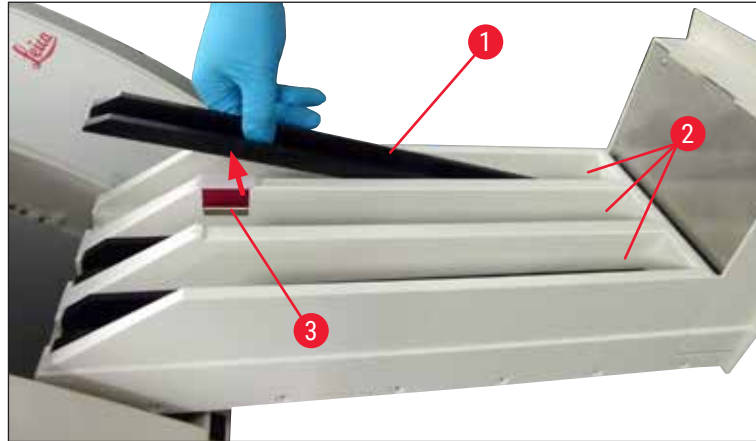

Fig. 8

4. Finally, lift the unload drawer and slide it back in the instrument.

4.4.2 Inserting the waste tray

- » Remove the waste tray (→ Fig. 9-1) from the packaging and insert it into the instrument at the recess (→ Fig. 9-2) provided.

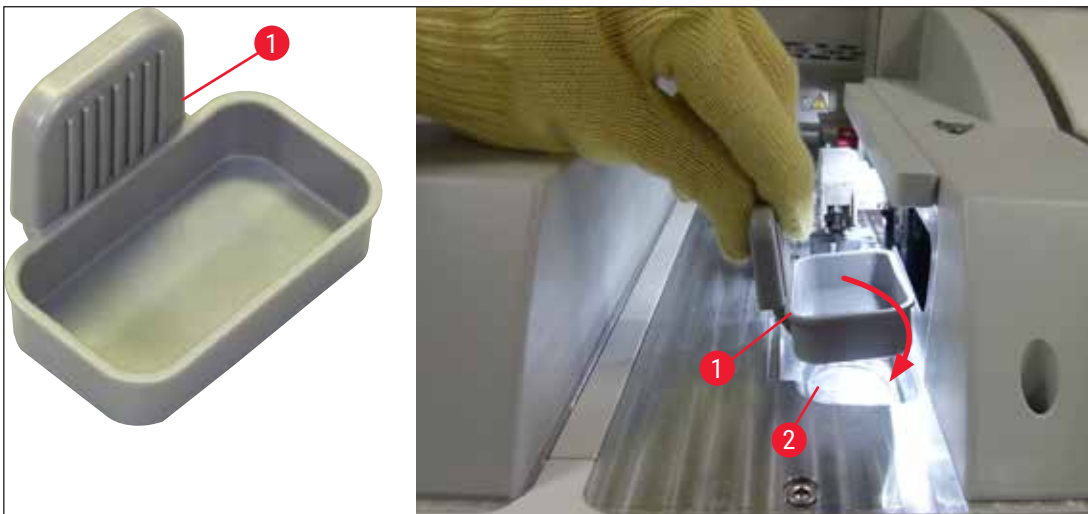

Fig. 9

4.4.3 Filling and inserting the needle cleaning container

**Warning**

The safety notes for reagent handling must be observed!

- Caution when handling solvents!
- Always wear suitable lab protective clothing, as well as gloves and safety goggles, when handling reagents.
- Always fill or drain needle cleaning containers outside of the instrument in compliance with safety information to avoid or reduce the risk of spilling reagents.

**Note**

- The needle cleaning container is used for holding the needle during instrument breaks. Immersing the needle in the filled xylene prevents the needle from becoming stuck and allows it to remain permeable.
- A filled needle cleaning container must be used in both coverslip line **L1** and **L2**.
- Before inserting the needle cleaning container, make sure that the complete unit for the needle cleaning container (→ P. 112 – 7.2.10 Removing the complete unit of the needle cleaning container) has been fixed in both coverslip lines during initial installation.
- Do not leave the needle in the park position for longer than necessary in order to prevent drying out.

1. Switch on the instrument (→ P. 30 – 4.5 Switching on and shutting down the instrument).
2. Switch to the **Module Status** (→ P. 74 – 5.11 Module status) and press the **Prime/Clean** button of coverslip line **L1** or **L2** in order to lift the respective needle holder.
3. Move the shifter (→ Fig. 10-1) into a position that enables access to the slot for the needle cleaning container (→ Fig. 10-2).
4. Remove the needle from the holder and plug into the parking location (→ Fig. 3-10).
5. Remove the needle cleaning container (→ Fig. 10-3) from the packaging and fill with xylene to the bottom edge of the cap, outside of the instrument (→ Fig. 10-5).
6. Following this, plug the needle cleaning container in the slot and press downwards until it clicks into place.
7. Remove the needle from the parking location and plug it back into the holder (→ Fig. 87).



Fig. 10

**Note**

- If it is impossible to lift the needle cleaning container by rotating the knurled screw clockwise (it might be clogged with residual mountant), it can be removed as described in (→ P. 112 – 7.2.10 [Removing the complete unit of the needle cleaning container](#)).
- The needle has a notch (→ Fig. 87-3) that fits exactly in the holder. The Attention symbol (→ Fig. 87-4) on the holder (→ Fig. 87-2) indicates to the user that utmost care is required when inserting the needle into the holder. The needle must be inserted straight and all the way in order to make sure that no negative impact on the samples arises during processing.

4.5 Switching on and shutting down the instrument**Warning**

The instrument must be connected to a grounded power socket. For additional electrical fuse protection, connecting the HistoCore SPECTRA CV to a socket with a residual current circuit breaker (RCCB) is recommended.

**Note**

- The needle cleaning container must be filled with xylene (→ P. 29 – 4.4.3 [Filling and inserting the needle cleaning container](#)), since otherwise initialization cannot be successfully performed.
- During the instrument setup or if no consumables (mounting medium and coverglass) have been added, the modules are displayed in the display as empty (→ Fig. 22).

1. Switch the **Main switch** on the front of the instrument (→ Fig. 1-8) to **ON** ("I").
2. Fill the needle cleaning container with a sufficient amount of xylene (→ P. 29 – 4.4.3 [Filling and inserting the needle cleaning container](#)).
3. A few seconds after switching on the **Main switch**, the **Operating switch** is illuminated in orange (→ Fig. 11-1). The software's start process ends when the **Operating switch** is illuminated in red.

**Note**

Pressing the **Operating switch** in the orange phase does not start the instrument.

Switching on and shutting down the instrument in workstation mode**Warning**

If the HistoCore SPECTRA CV is operated together with a HistoCore SPECTRA ST as workstation (→ P. 102 – 6.7 [Workstation operation](#)), a message is always displayed upon switching on the HistoCore SPECTRA CV. This information message instructs the user to ensure that the reagent vessels in the load drawer are sufficiently filled (→ P. 38 – [Correct fill level of the reagent vessels](#)) and the covers have been removed. Note the information message and confirm with **OK**. Failure to observe this information message this may lead to a loss of specimen and instrument faults.



Fig. 11

4. To start the instrument, now press the illuminated in red **Operating switch** (→ Fig. 11-1); an audible signal sounds.
5. During initialization, a verification of all stations (**fill level scan**) is carried out automatically. Furthermore, the level of the needle cleaning containers is checked during operation approximately every 4 hours.
6. The **Operating switch** is illuminated in green whenever the instrument is ready to start.
7. After completing the initialization phase, the **Main menu** (→ Fig. 12) appears on the screen.



Fig. 12

Shutting down the instrument

1. To switch the instrument into standby mode (e.g. overnight), remove all racks from the instrument and then press the **Operating switch** (→ Fig. 11-1) twice. It then illuminates in red.



Note

If there is a rack in the instrument while the **Operating switch** is pressed, the user receives an information message indicating that the instrument cannot be shut down until the rack is no longer in the process or no longer present in the instrument. Any processing in progress is continued.

2. For cleaning and maintenance, switch off the instrument at the **Main switch** and also observe the instructions in (→ P. 106 – 7.1 Important notes about cleaning this instrument).

4.6 Refilling consumables



Warning

- Only original consumables that have been verified by Leica may be used (→ P. 158 – Consumables) in order to avoid instrument faults.
- Caution when handling solvents!
- Always wear protective clothing suitable for laboratory use, as well as rubber gloves and safety goggles when handling the chemicals used in this instrument.
- Only clean reagent vessels should be used (→ P. 119 – 7.2.17 Cleaning reagent vessels in the load drawer).
- Always fill or drain reagent vessels and the needle cleaning container outside of the instrument in compliance with safety information to avoid or reduce the risk of spilling reagents into other reagent vessels and onto interior instrument components.
- Proceed carefully and thoroughly when filling or draining and follow the respective applicable laboratory specifications. Remove spilled reagents immediately. If a reagent vessel in the load drawer has been contaminated, cleaning and refilling it is mandatory.



Note

- Validated coverglass (→ P. 70 – 5.9.4 Properties of the coverglass) and a validated mounting medium (→ P. 70 – 5.9.3 Properties of the mounting medium) are available for the HistoCore SPECTRA CV. Ordering information: (→ P. 158 – Consumables).
- A check and a scan of the consumables is always performed after the hood has been closed.



Note

- If fewer than 300 slides are coverslipped per day on an ongoing basis, the HistoCore SPECTRA CV can also be operated with just a single coverslip line. In this configuration, do not fill any consumables (mounting medium, coverglass) in the unused coverslip line.
- Please note: Each time a rack is inserted into the load drawer, the software indicates to the user that there are missing consumables in the unused line. Confirm each of the respective information messages with **OK**.

4.6.1 Inserting a coverglass cartridge

**Note**

- Validated coverglass (→ P. 70 – 5.9.4 Properties of the coverglass) are available for the HistoCore SPECTRA CV. The coverglasses are only available packaged in magazines. The magazines are automatically read by the instrument when inserted and the data is sent to the consumables management system (CMS) (e.g. number and size).
- Only original coverglass that has been verified by Leica may be used (→ P. 158 – Consumables) in order to avoid instrument faults.
- The packaging should not be opened until immediately before inserting the coverglass cartridge into the instrument. This prevents a possible sticking of the coverglass due to humidity.
- An RFID chip is integrated into the coverglass cartridge, which ensures that the consumables management system (CMS) is given reliable information about the coverglass used (size and remaining amount).

**Warning**

Before inserting the coverglass cartridge (→ Fig. 13-1), remove both the packaging foam (→ Fig. 13-2) and the silica gel packet (→ Fig. 13-3).

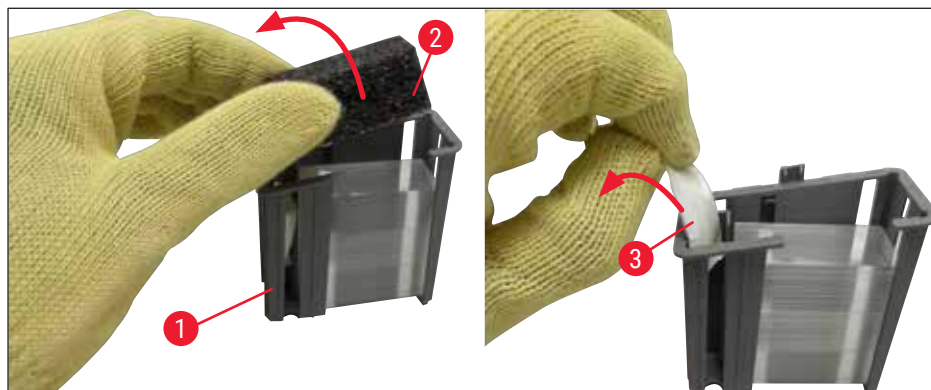

Fig. 13

1. Open the hood.
2. The Pick&Place module is located above the waste tray.
3. Unpack the coverglass cartridge (→ Fig. 13-1) and remove the foam insert (→ Fig. 13-2) and silica gel packet (→ Fig. 13-3).
4. Insert the coverglass cartridge (→ Fig. 14-1) into the slot for the coverglass cartridge (→ Fig. 14-2).
5. Close the instrument hood.
6. The coverglass cartridge data is imported and the **Module Status** (→ Fig. 22) is updated.



Fig. 14

4.6.2 Inserting the mounting medium bottle and prime bottle

1. Open the hood.
2. Grasp the bottle sledge on the handle (→ Fig. 16-1) and move it all the way forward.

Inserting the prime bottle

- » Insert the prime bottle (→ Fig. 16-2) into the position provided for it (→ Fig. 3-11) in the bottle sledge.

Inserting the mounting medium bottle



Note

- Before the insertion of a mounting medium bottle in the instrument, the expiration date (imprint on the packaging and on the bottle label (→ Fig. 15-3)) is to be checked. If the expiration date has been reached or exceeded, the mounting medium may no longer be used. Expired mounting medium is to be disposed of in accordance with the applicable on-site lab guidelines.
- Opened mounting medium has a storage life of 14 days, within which it must be used up. We recommend making a note of the use-date on the bottle label.
- Only original mounting medium that has been validated by Leica may be used (→ P. 158 – Consumables) in order to prevent instrument faults.



Warning

Ensure the correct assignment of the cannulas (→ Fig. 16-4) to the respective mounting medium bottles to prevent instrument faults. The cannula with the mark 1 is to be inserted into the mounting medium bottle in position 1 and the cannula with the mark 2 into the mounting medium bottle in position 2 of the bottle sledge (→ Fig. 16-3).

**Note**

The insertion of a mounting medium bottle in the coverslip line **L1** is described below. The same procedures also apply for the coverslip line **L2**.

1. Take the mounting medium bottle (→ Fig. 15) out of the packaging and remove the black plastic cap (→ Fig. 15-1).

**Note**

Do not dispose of the black cover cap. If a non-empty bottle of mounting medium is taken out of the instrument (e.g. in the event of transport), it can be closed up again using the black plastic cap and retained. However, while doing so, the expiration date of the opened bottle must be observed.

**Warning**

- Do not remove the white plastic seal (→ Fig. 15-2). It must remain on the bottle.
- Before the initial insertion of the cannulas, check whether the caps on the ends of the cannulas have been removed.



Fig. 15

2. Insert the mounting medium bottle into the recess **L1** and make sure that the RFID chip (→ Fig. 15-4) is seated in the notch of the recess (→ Fig. 16-5).

4 Installation and Instrument Setup

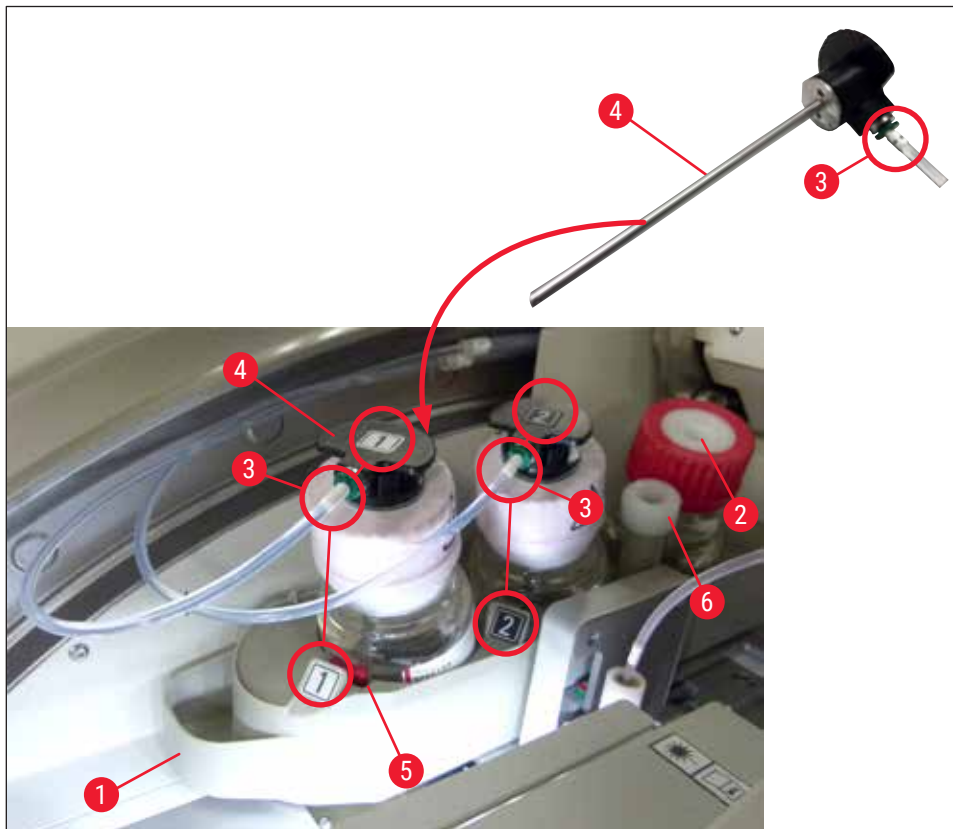

Fig. 16

3. Carefully insert the cannula (→ Fig. 16-4) with the label 1 into the opening of the mounting medium bottle until it clicks into place. This process involves puncturing the white protective membrane.



Warning

Puncturing the white protective membrane briefly requires an increase in force. Therefore, proceed carefully to avoid slipping from your hand.

4. Repeat the process for bottle **L2**.
5. Slide the bottle sledge (→ Fig. 16-1) back until you feel it click into place.
6. Close the hood.
7. The mounting medium bottles that are inserted are detected by the instrument software and the **Module Status** (→ Fig. 22) is updated.



Note

The software identifies the insertion of the new bottles and informs the user that an **Extended Prime** is necessary for both coverslip lines (→ P. 123 – 7.3.2 **Extended Prime**). Only afterwards is the instrument ready to start.

4.6.3 Prepare the reagent vessel, fill it and insert it into the load drawer

To ensure that everything runs smoothly in the instrument, observe the following notes and proceed as follows.

Attaching the reagent vessel handle:

- » Check whether the reagent vessel handle is correctly attached to the reagent vessel. If this is not the case, fasten the handle according to (→ Fig. 17).

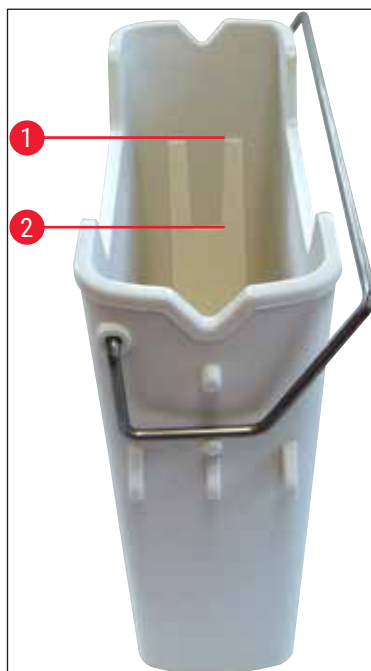

Fig. 17

Correct filling of reagent vessels:



Note

- The reagent vessel must be filled with xylene (→ P. 32 – 4.6 Refilling consumables).
- Reagent vessels must always be filled outside the instrument.
- Make sure that the reagent vessel handle is not bent. During the removal of the reagent vessel, if the handle is bent out of shape, it may detach from the reagent vessel and the reagent could be spilled.



Warning

The safety notes for reagent handling must be observed!

4 Installation and Instrument Setup

Correct fill level of the reagent vessels



Note

- When filling the reagent vessels, observe the fill level marks inside the reagent vessels.
- Use the label covers contained in the (→ P. 18 – 3.1 Standard delivery – packing list) to label the reagent vessels in the load drawers.
- The label covers with the letter **S** printed on them (→ Fig. 18-2) indicate to the user that the reagent vessel has been filled with a solvent (xylene).
- Use the non-labeled covers only in cases where the reagent vessels are empty (e.g. after shutting down the instrument).

A sufficient fill level is ensured if the level of the reagents is between the maximum (→ Fig. 17-1) and the minimum (→ Fig. 17-2) fill level mark.

Inserting the reagent vessels into the load drawer:

1. To insert the reagent vessels, press the drawer button for the load drawer (→ Fig. 1-4).
2. The load drawer opens.
3. Remove the reagent vessel and fill it with a HistoCore SPECTRA ST xylene outside the instrument in accordance with the safety instructions.
4. Then insert the filled vessel back into the load drawer (→ Fig. 18-1).
5. Close the load drawer by pressing the drawer button again.

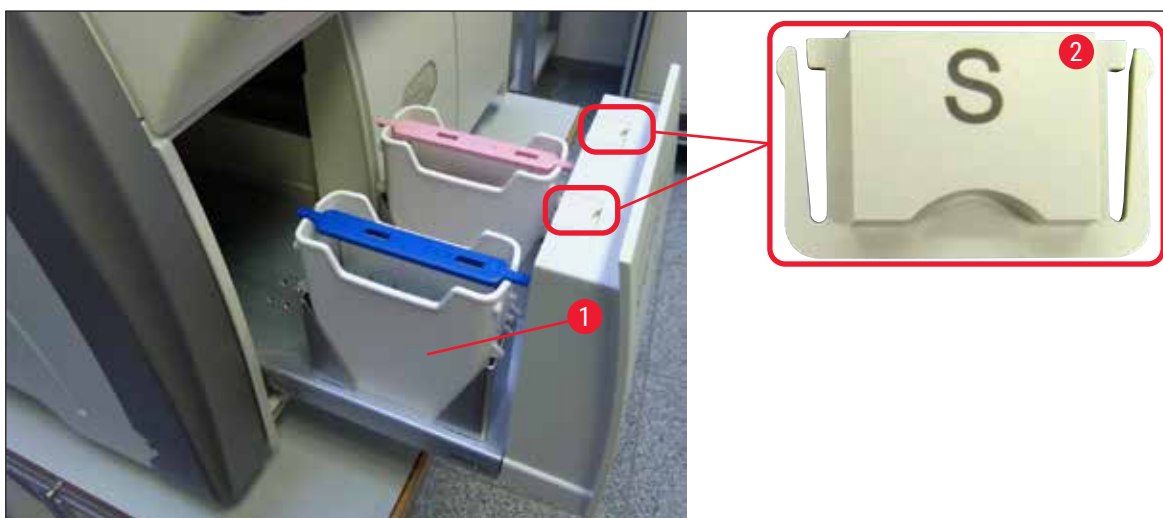

Fig. 18

5. Operation

5.1 User interface – overview

The HistoCore SPECTRA CV is programmed and operated using a color touchscreen. If there is no processing in progress, the screen displays the following main window (→ Fig. 19) after switching on.

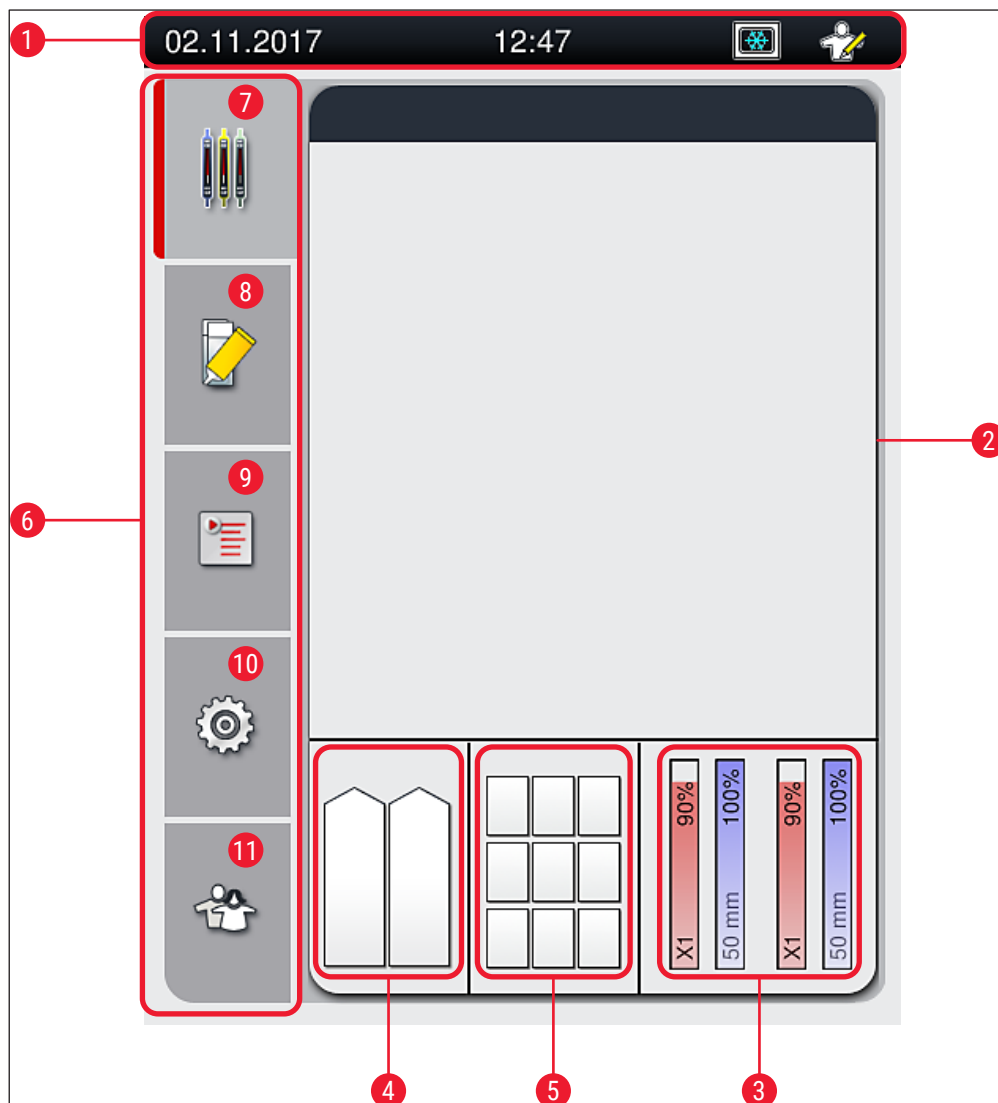

Fig. 19

1	Status bar	7	Process status display menu
2	Process status display	8	Module status menu
3	Consumables status display	9	Parameter sets menu
4	Load drawer status display	10	Settings menu
5	Unload drawer status display	11	User Settings menu
6	Main menu (→ P. 45 – 5.6 Main menu overview)		

5.1.1 Grayed out function keys



Note

No changes can be carried out in the settings during processing or while there are racks in the instrument (load drawer, unload drawer, oven, coverslip line). Corresponding function keys are grayed out and therefore deactivated.

However, at all times it is possible to:

- Refill consumables (mounting medium, coverglass)
- Run the cleaning programs **Quick Prime**, **Extended Prime** and **Clean the Hose System**,
- Switch from **Standard User Mode** to the **Supervisor Mode**.

5.2 Elements of the status display

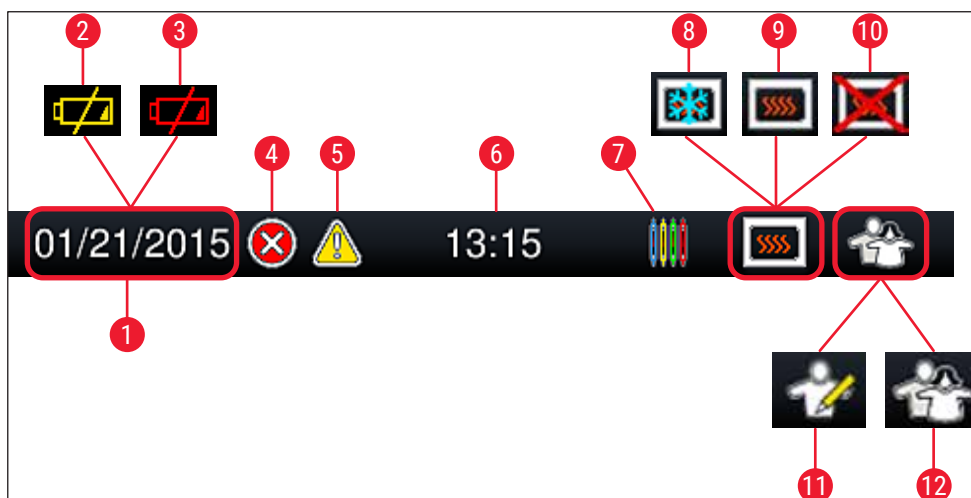

Fig. 20

- 1 Current date
- 2 If the remaining service life for the battery is about 3 months or less, this symbol appears on the status bar instead of the date. A notification is sent to the user at the same time.
- 3 If the service life of the battery has expired, this symbol appears on the status bar instead of the date. A notification that the battery needs to be replaced by a Leica service technician is sent to the user at the same time.
- 4 If alarms and error messages are displayed during operation, this alarm symbol appears. Pressing this symbol allows the last 20 active messages to be viewed again.
- 5 If warnings and notes are displayed during operation, this notification symbol appears. Pressing this symbol allows the last 20 active messages to be viewed again.
- 6 Local time
- 7 The **Process** symbol indicates that processing is currently active and that a rack may still be in the unload drawer or a rack from the HistoCore SPECTRA ST is expected.
- 8 This symbol displays that the oven is active and is in the heating phase.
- 9 This symbol displays that the oven is active and is ready to operate.
- 10 This symbol displays that the oven has been deactivated.
- 11 The operation of the instrument in **Supervisor Mode** is displayed by this symbol. This mode provides additional operation and adjustment options for trained staff. Access to this mode is password-protected.
- 12 This **User** symbol displays that the instrument is in user mode, which permits a simplified instrument operation without password.

5 Operation

5.3 Process status display

- In the **Process status display** (→ Fig. 19-2), all racks in the process (→ Fig. 21-2) are displayed in color of the respective rack handle.
- The status bar (→ Fig. 21-1) for the main window lists the parameter sets that can currently be started with the number and color assigned to the rack handles. These symbols are also visible if the daily **Quick Prime** (→ P. 122 – 7.3.1 Quick Prime) has not yet been carried out.



Note

Each ongoing processing is illustrated by a rack handle symbol. It is shown in the same color as the actual rack handle. Various information is displayed on the handle symbol (→ Fig. 21).

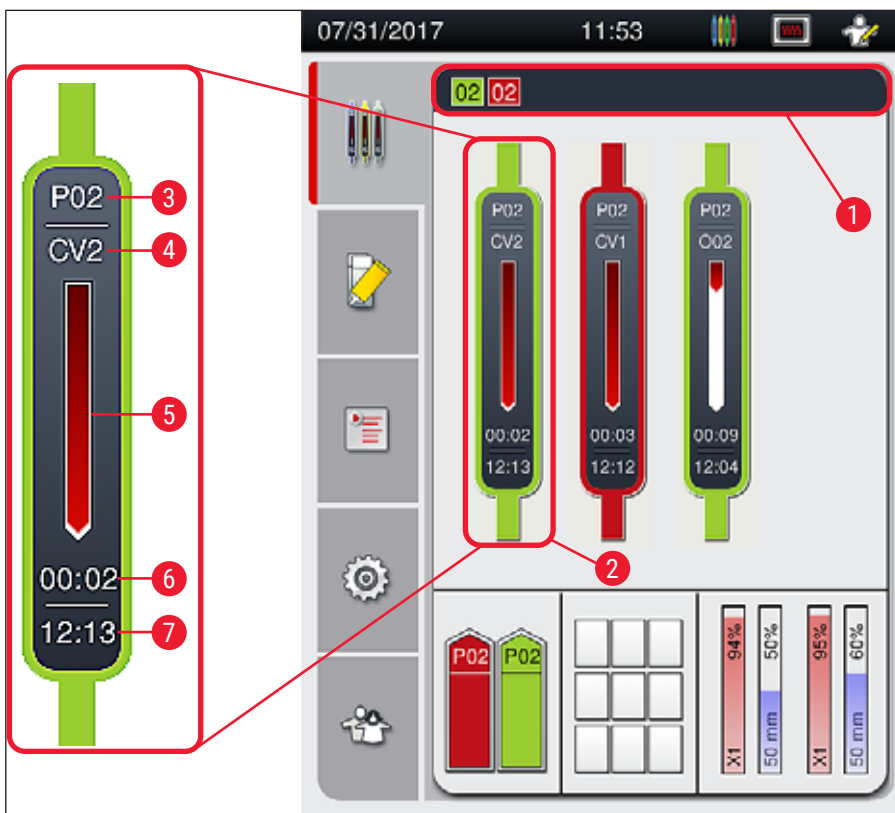

Fig. 21

- | | | | |
|---|---|---|----------------------------------|
| 1 | Parameter sets that can be started | 5 | Progress display of processing |
| 2 | Racks in the process | 6 | Estimated remaining time (hh:mm) |
| 3 | Parameter set number | 7 | Time at end of process |
| 4 | Current position of the rack in the instrument:
CV1/CV2 = coverslip line L1/L2, ROT = rotator, O01/O02 = oven position 1/2 | | |

5.4 Consumables Management System (CMS)



Note

To call up this menu, press the **Module Status menu** (→ Fig. 19-8) button.

The HistoCore SPECTRA CV has a Consumables Management System (CMS) that automatically monitors various levels and notifies the user of the following details:

- Mounting medium designation (→ Fig. 22-1)
- Remaining number of slides (→ Fig. 22-2)
- Coverglass length (→ Fig. 22-3)
- Remaining number of coverglass (→ Fig. 22-4)
- The percentage display (→ Fig. 22-5) (→ Fig. 22-6) displays the consumption status of the mounting medium and the coverglasses in the respective left or right coverslip line. The colored portion of the bar lowers accordingly as usage continues.

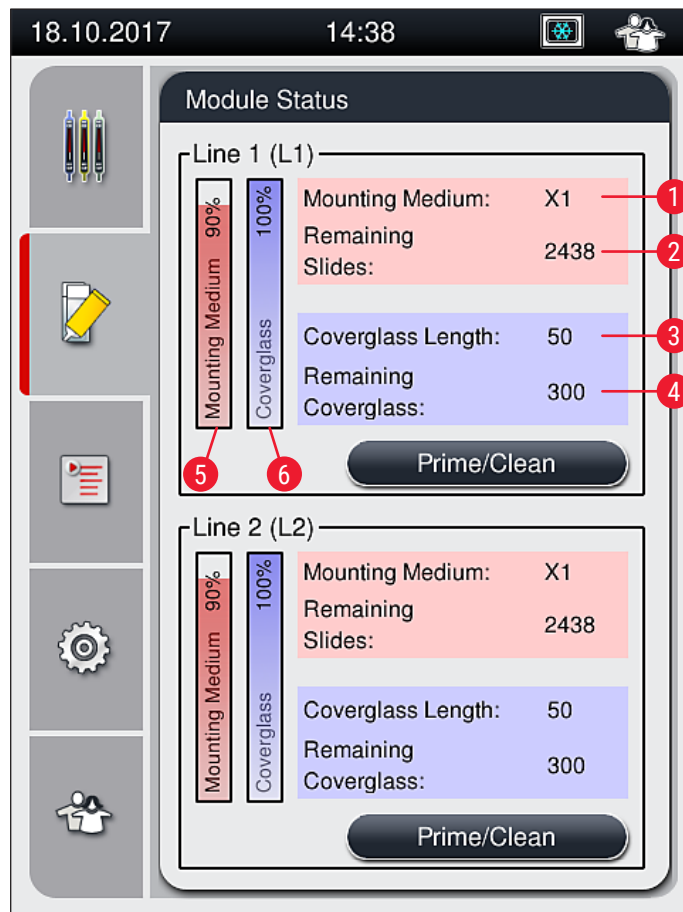

Fig. 22

5.5 Displaying the drawers

The lower area of the main window (→ Fig. 23) shows the status of the load drawer, the unload drawer and the consumables (coverglass and mounting medium).

- The stations depicted by a directional arrow in the instrument (→ Fig. 23-1) symbolize the load drawer.
- The center area (→ Fig. 23-2) displays the assigned and available positions in the unload drawer.
- The right-hand area (→ Fig. 23-3) shows the state of the filled consumables (coverglass and mounting medium).
- After closing the load drawers, the instrument automatically detects any inserted or removed racks.
- The racks in both drawers are shown on the screen with the respective rack handle color (→ Fig. 23-1) (→ Fig. 23-2). Available positions are displayed as empty.

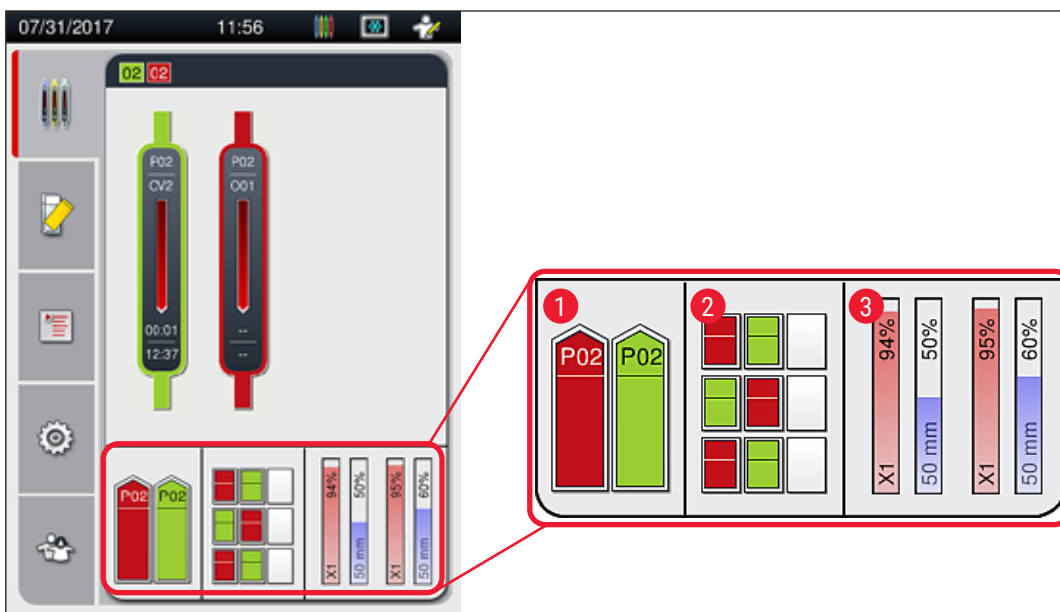

Fig. 23



Note

The drawers can be opened when the drawer buttons (→ Fig. 1-4) and (→ Fig. 1-5) light up green. A drawer button is illuminated in red and cannot be opened in the following cases:

- If there is a rack transported by the instrument in the load or unload drawer,
- If a rack is to be transferred from the HistoCore SPECTRA ST to the HistoCore SPECTRA CV,
- If a rack is being turned in the rotator
- If a rack is being inserted into the rack elevator or removed from the rack elevator.

**Warning**

For manual loading of the HistoCore SPECTRA CV in workstation mode, the user is responsible to pay attention to racks being transferred from the HistoCore SPECTRA ST to the HistoCore SPECTRA CV at the same time. The end times of the HistoCore SPECTRA ST have to be taken into account before loading manually since otherwise there can be delays in the HistoCore SPECTRA ST that can affect the staining result.

5.6 Main menu overview

The **Main menu** (→ Fig. 19-6) is located on the left side of the display, which is divided as described below. This menu is visible in all submenus and allows switching to another submenu at any time.



The **Process Status Display** (→ Fig. 19-7) displays the current status of all racks in process. Here, the respective handle of the rack is displayed in representational form with the respective color. This display shows the standard display.



The **Module Status** (→ Fig. 19-8) displays an overview of the consumables filled for the respective coverslip line (mounting medium and coverglasses) and enables access to the cleaning and priming options menu for the two coverslip lines.



The **Parameter sets** (→ Fig. 19-9) menu is used to create and manage parameter sets.



Basic settings can be configured in the **Settings** (→ Fig. 19-10) menu. The language version, date and time and other parameters can be adapted to local requirements here. The oven can be switched on or shut down.

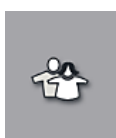

In the **User Settings** (→ Fig. 19-11) menu, a custom password can be set up to prevent modifications to the parameter sets by unauthorized persons (**Supervisor Mode**). However, the instrument can be used without a password in the standard **User Mode**.

5 Operation

5.6.1 Entry keyboard



Note

A keyboard appears (→ Fig. 24) for required entries (creating or entering a password). It is operated using the touchscreen.

Note that the keyboard display depends on the configured language.

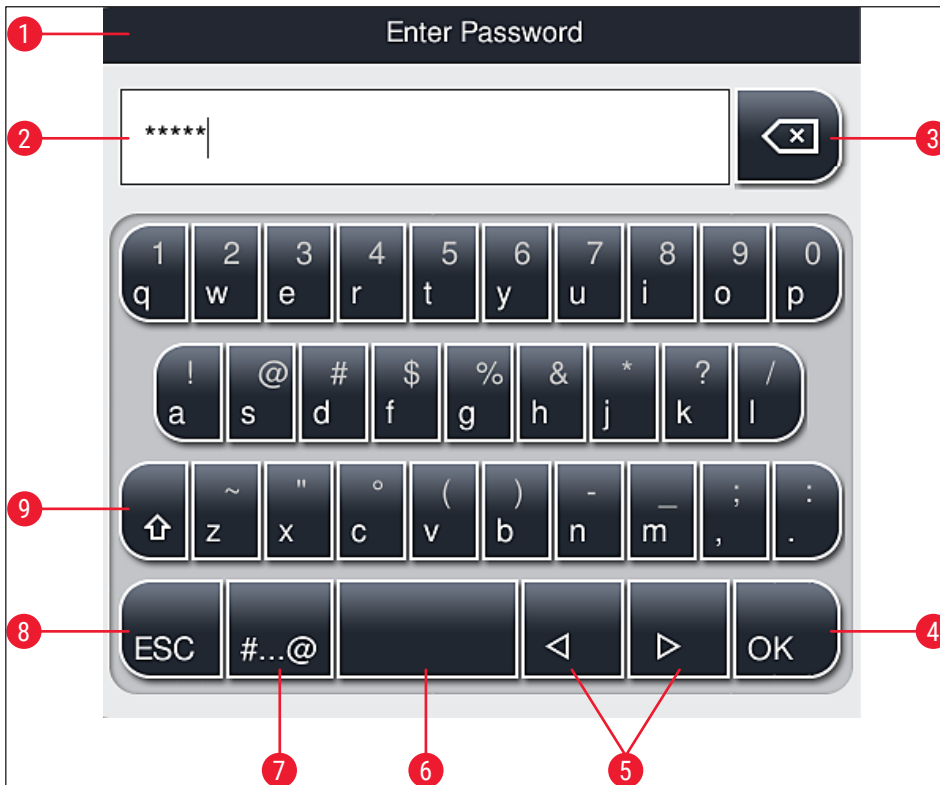

Fig. 24

- 1 Title bar
- 2 Input field
- 3 Delete the most recently entered character
- 4 Confirmation
- 5 Move cursor to left or right
- 6 Space key
- 7 Special character shift button (→ Fig. 25)
- 8 Cancel (entries are not saved!)
- 9 Upper and lowercase (pushing the button twice activates caps lock, indicated by the button turning red. Pressing again re-activates lowercase.)

Special character keyboard



Fig. 25

Other special characters

1. To enter a special character or umlaut, etc. not included in the special character keyboard (→ Fig. 25), hold the corresponding normal button on the keyboard.
2. Example: Holding the standard "a" button brings up other selection options (→ Fig. 26).
3. Select the required character from the new single-line keyboard by pressing it.



Fig. 26



Note

Number of characters for passwords: min. 4 to max. 16 characters.

5.7 User settings



This menu can be used to configure the appropriate access level. A distinction is made between the following:

- Standard user
- Supervisor (password-protected)
- Service technician (password-protected)



Standard user:

The standard user does not need a password and can use the completely configured instrument for all routine applications. It is not possible for this user group to modify programs and settings.



Supervisor:

The supervisor has the same access options as the standard user, but when the instrument is in idle mode, they can also create, edit and delete parameter sets, change settings and perform the instrument setup functions. Therefore, supervisor access is password-protected.

To activate supervisor mode, proceed as follows:

1. Press the **Supervisor** button (→ Fig. 27-1).

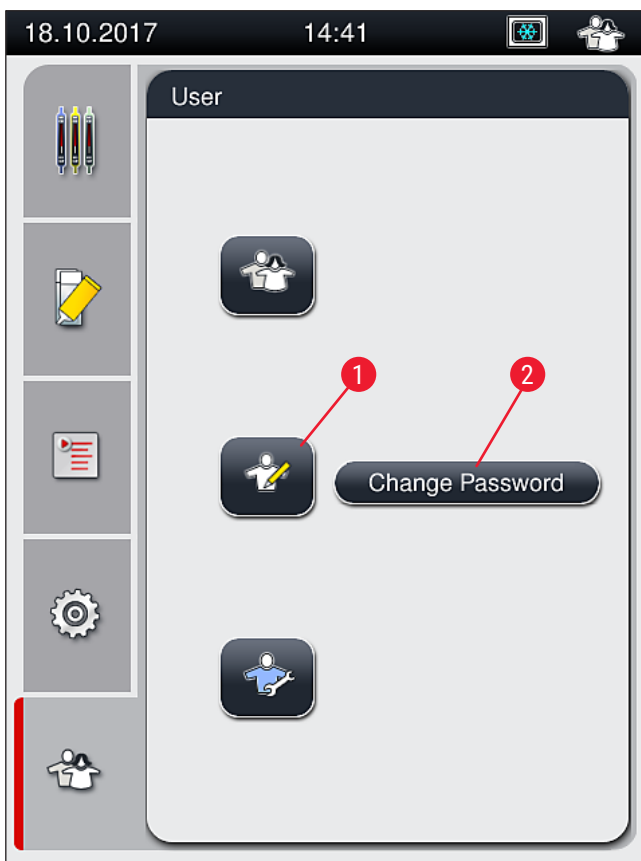

Fig. 27

2. A keyboard (→ Fig. 28) is then displayed which can be used to enter the password.

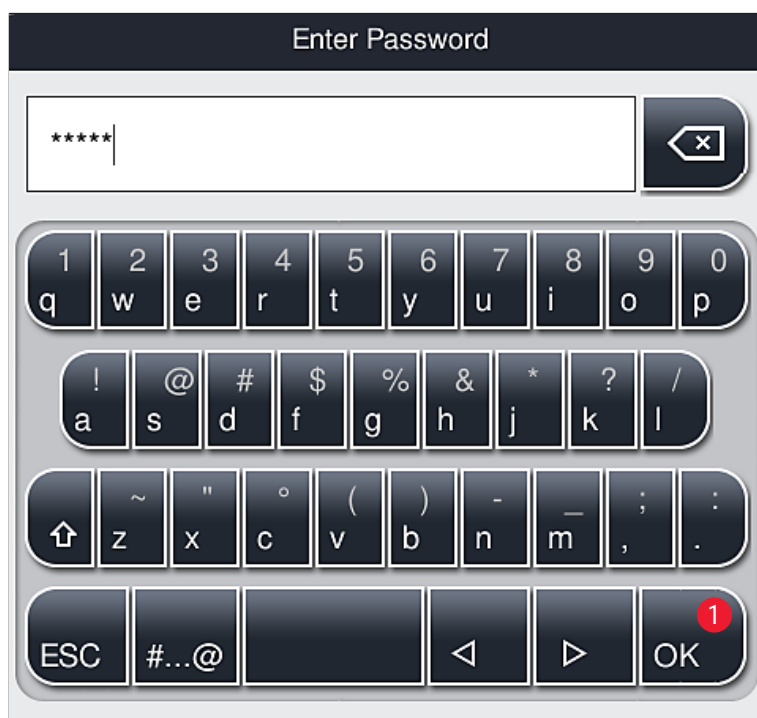

Fig. 28

3. The entry is finished by confirming with **OK** (→ Fig. 28-1) and the entered password is checked for validity.
- ✓ The current user status is displayed with the respective symbol in the status bar (→ Fig. 20) on the top right.

**Note**

- The password configured at the factory should be changed during the initial setup.
- The **Supervisor Mode** will be reset to **Standard User** after 15 minutes of inactivity. Unsaved changes will be discarded!
- It is recommended to exit **Supervisor Mode** when all desired changes have been made and saved. To log out, press the **Standard User** button from the **User Settings** menu.

To change the supervisor password, proceed as follows:

1. To change the password, press the **Change Password** button (→ Fig. 27-2) and enter the old password.
2. Then, enter the new password twice using the keyboard and confirm with **OK**.

**Note**

A password must have at least 4 characters and may have up to 16 characters.



Service technician:

The service technician can access system files and carry out basic settings and tests.



Note

Access to this service area of the software is only possible for technicians trained by Leica and certified for this instrument type.

5.8 Basic settings

The **Settings** (→ Fig. 29-1) menu is opened by pressing the gear symbol (→ Fig. 29). Basic instrument and software settings can be configured in this menu.

- Touching one of the displayed symbols, e.g. **Language** (→ Fig. 29-2), opens the corresponding submenu.

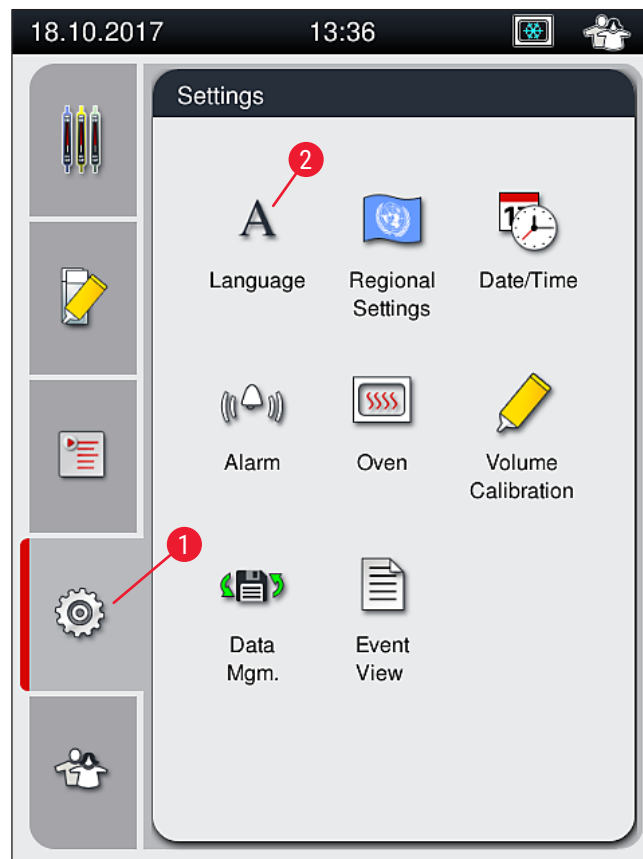

Fig. 29



Note

The individual submenus are described in the following chapters.

5.8.1 Language settings

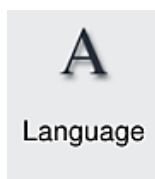

Required access level: Standard user, supervisor

- The language selection menu is displayed by pushing the symbol for the **Language** (→ Fig. 29-2). This menu contains an overview of all languages installed in the instrument and allows the desired display language to be selected.
- Select the desired language and confirm by hitting **Save**.
- The screen display and all information messages and labels are displayed immediately in the currently configured language.



Note

A supervisor or Leica service technician can add other languages (if available) by using Import (→ P. 61 – 5.8.7 Data management).

5.8.2 Regional settings

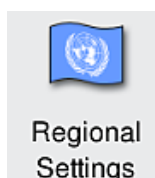

Required access level: Standard user, supervisor

Basic format settings can be carried out in this menu.

Date format:

- Configure the date display (→ Fig. 30-1) to international, ISO or US format by pressing the corresponding radio button (→ Fig. 30-2).
- The activated setting is labeled by a red border (→ Fig. 30-2).

Time format:

- The time display can be changed from a 24-hour display to a 12-hour display (a.m. = morning/p.m. = afternoon) using the slider (→ Fig. 30-3).
- Pushing the **Save** (→ Fig. 30-5) button saves the settings.
- If you do not want to apply the settings, press the **Back** (→ Fig. 30-4) button to return to the previous menu.

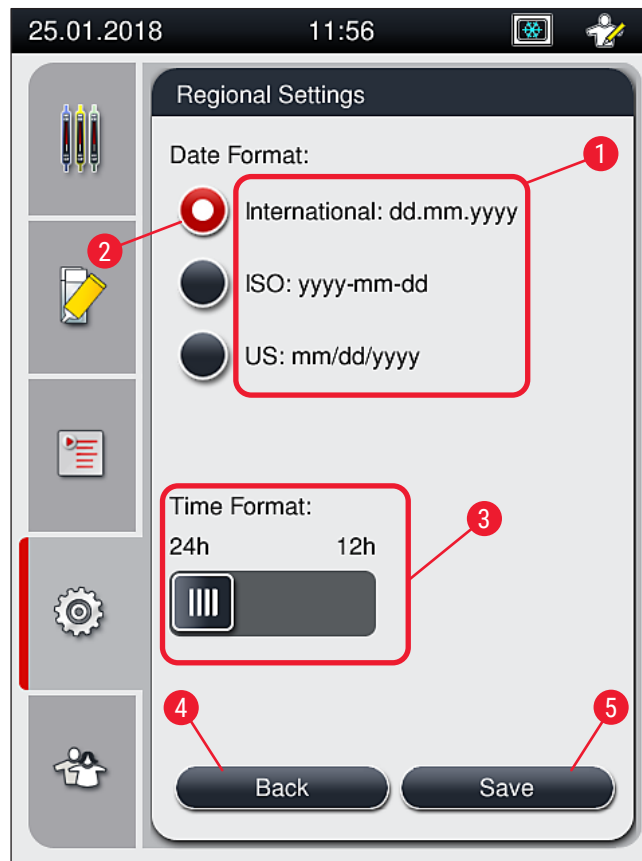
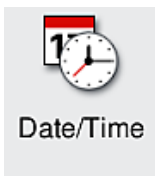

Fig. 30

5.8.3 Date and time



Required access level: Standard user, supervisor

The current date (→ Fig. 31-1) and local time (→ Fig. 31-2) can be configured in this menu by rotating the individual rollers.

- Pushing the **Save** (→ Fig. 31-4) button saves the settings.
- If you do not want to apply the settings, press the **Back** (→ Fig. 31-3) button to return to the previous menu.

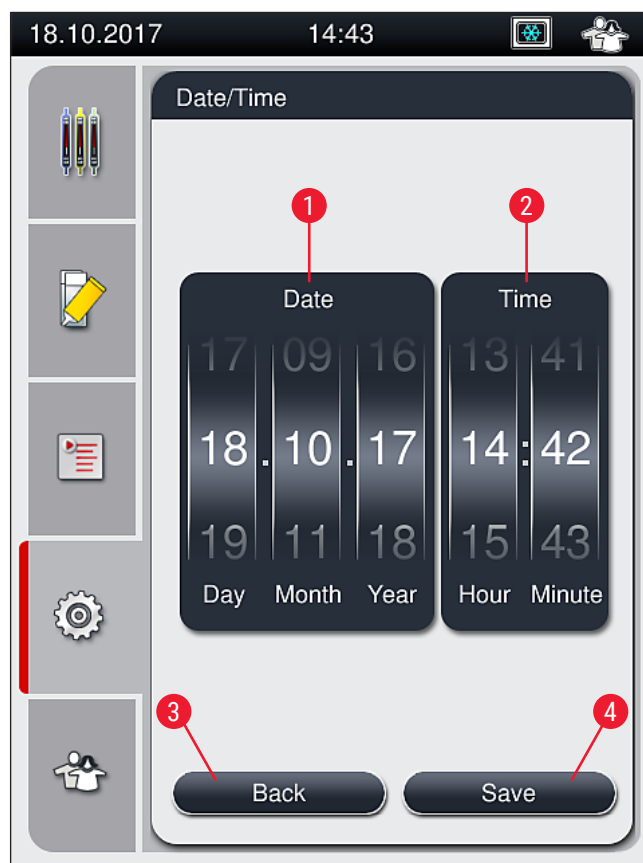

Fig. 31



Note

In the 12-hour display, a.m. (morning) and p.m. (evening) are displayed under the hour digits to enable a correct setting.
 The time and date settings cannot deviate more than 24 hours from the system time configured at the factory.

5.8.4 Menu for alarm sounds – Error and signal sounds

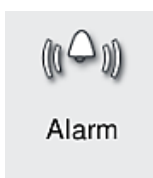

Required access level: Standard user, supervisor

In this menu, audible note and error signals can be selected, the volume can be configured and functionality can be tested.

The current setting for alarm and error sounds is displayed after calling up the menu.



Warning

After starting the instrument, an error sound is played. If this does not occur, the instrument may not be operated. This protects the specimens and the user. In this case, contact the responsible Leica service organization.

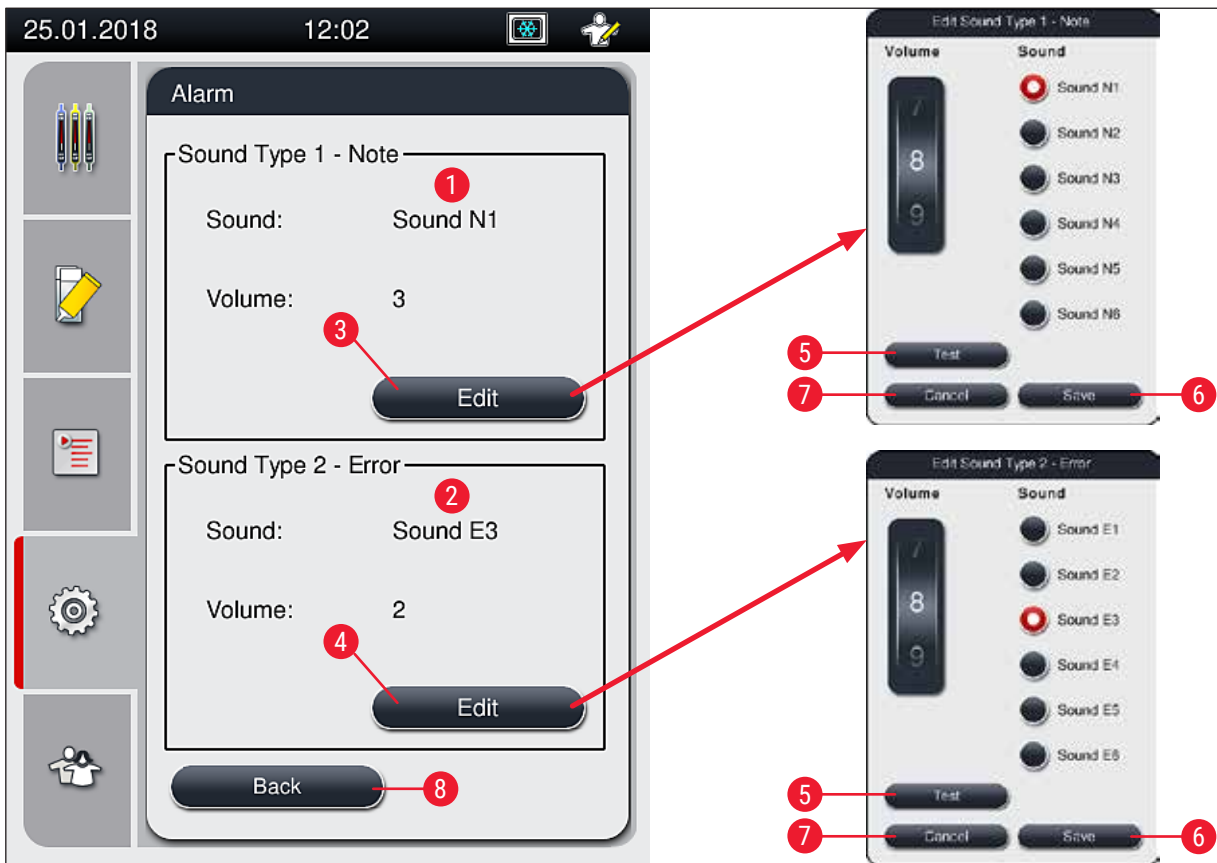

Fig. 32

Sound Type 1 - Note (→ Fig. 32-1)

Signal sounds are issued if warning messages or notifications are displayed on the screen. You can select from a list of 6 sounds. To change the settings, press the **Edit** (→ Fig. 32-3) button. The **Test** (→ Fig. 32-5) button can be used to listen to the respective sound. The volume can be adjusted incrementally by turning the roller (0 to 9).

Sound Type 2 - Error (→ Fig. 32-2)



Warning

The user must stay within earshot during the operation in order to react immediately during instrument malfunctions.

Error sounds are issued if an error message is displayed on the screen. This requires immediate intervention from the user. To change the settings, press the **Edit** (→ Fig. 32-4) button.

- The volume setting for error sounds is adjusted using the **Volume** roller. Six different sounds are available for the alarm types. The **Test** (→ Fig. 32-5) button can be used to listen to the respective sound.
- The volume can be adjusted incrementally by turning the roller.



Note

The acoustic error sounds cannot be disabled. The minimum configurable value for the volume is 2. The maximum value is 9.

- Pushing the **Save** (→ Fig. 32-6) button saves the settings. The **Cancel** (→ Fig. 32-7) button is used to close the selection window without applying the settings.
- Press the **Back** (→ Fig. 32-8) button to return to the **Settings** menu.

5.8.5 Oven settings

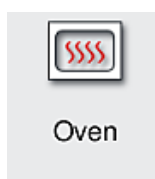

Required access level: Standard user, supervisor

The operating mode of the oven can be configured in the menu for oven settings (→ Fig. 33). The current oven settings are displayed after calling up the menu.



Note

- When starting the instrument, the oven is normally enabled and the **Exclude Oven Step** (→ Fig. 33-3) is disabled.
- The oven heats up to approx. 35 °C. As soon as a rack has been coverslipped, the oven continues heating up to approx. 40 °C. The symbol in the status bar changes from the status "heating up" (→ Fig. 20-8) to the status "ready to operate" (→ Fig. 20-9).
- The oven dries the cover slipped slides after completed processing for approx. 5 minutes. After the oven step has ended, the mounting medium is not completely dry. Treat the slides carefully during the removal from the rack to avoid a sliding of the coverglass.
- The temperature setting of the oven (maximum 40 °C) and the dwell time of the finished coverslipped slides are both configured at the factory and cannot be changed by the user.
- It can take up to 4 minutes for the oven to heat up!

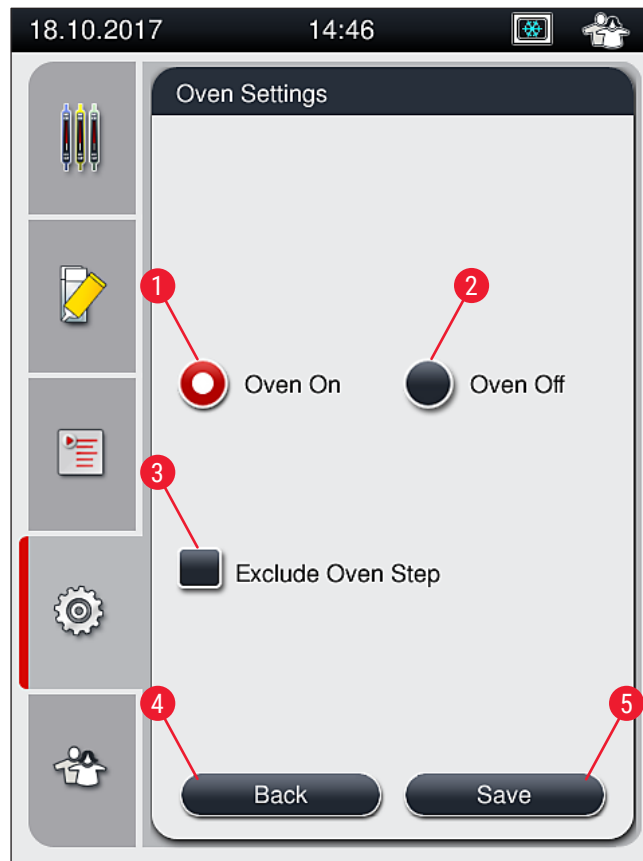

Fig. 33

Shutting down the oven

1. To shut down the oven, press the **Oven off** (→ Fig. 33-2) button.
2. If the oven is shut down, this is indicated by the button (→ Fig. 33-2) being colored red/white.
3. Apply the shutdown by pressing the **Save** (→ Fig. 33-5) button.
4. Observe both of the following information messages (→ Fig. 34-1) and (→ Fig. 34-2) and acknowledge each with **Ok**.
5. If you do not want to apply the settings, press the **Back** (→ Fig. 33-4) button to return to the previous menu without saving the changes.

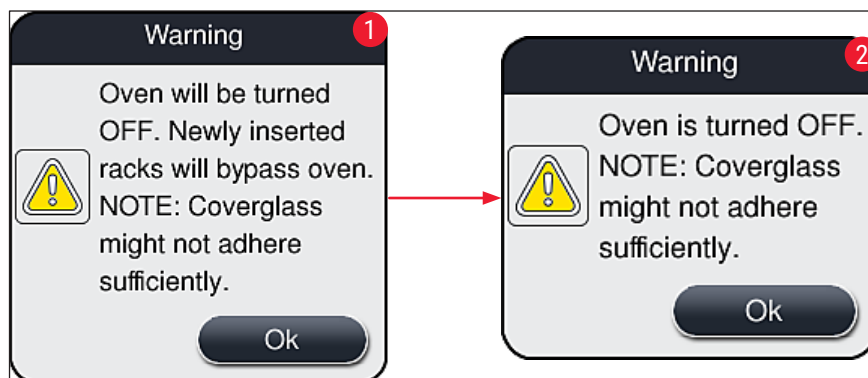

Fig. 34

**Note**

- If the oven is shut down, the slides are no longer transported to the oven after coverslipping; instead, they are deposited directly into the unload drawer.
- Processing is shortened by about 5 minutes.

**Warning**

If you shut down the oven, it is shut down immediately after pressing the **Save** button. Racks used earlier, and thus still in the process, go through the oven step in a slowly cooling oven. This can result in less effective drying and requires greater care when removing the slides from the rack.

Switching on the oven

1. To switch on the oven, press the **Oven On** (→ Fig. 33-1) button.
2. If the oven is enabled, this is indicated by the button (→ Fig. 33-1) being colored red/white.
3. Apply the activation by pressing the **Save** (→ Fig. 33-5) button and note the subsequent information message (→ Fig. 35) and confirm it with **OK**.



Fig. 35

**Warning**

After switching the oven back on, keep in mind that the oven takes up to 4 minutes to heat up. This can result in less effective drying for the initial racks and requires greater care when removing the slides from the rack.

Excluding the oven step

- ① The oven step at the end of processing can be disabled if necessary. In this case, the oven remains switched on and can be made available immediately again if necessary by reactivating the oven step. The heating phase is omitted.
1. To exclude the oven step, press the **Exclude Oven Step** (→ Fig. 33-3) button.

5 Operation

2. If the oven step is excluded, this is indicated by the button (→ Fig. 33-3) being colored red with an X.
3. Apply the configuration by pressing the **Save** (→ Fig. 33-5) button and note the subsequent information message (→ Fig. 36) and confirm it with **Ok**.



Fig. 36



Warning

Excluding the oven step leads to less effective drying and requires greater care when removing slides from the rack.

Including the oven step in the processing

1. To enable the oven step at the end of processing, press the **Exclude Oven Step** (→ Fig. 33-3) button.
2. If the oven step is enabled, no check mark in the (→ Fig. 33-3) button is displayed.
3. Apply the configuration by pressing the **Save** (→ Fig. 33-5) button and note the subsequent information message (→ Fig. 37) and confirm it with **Ok**.

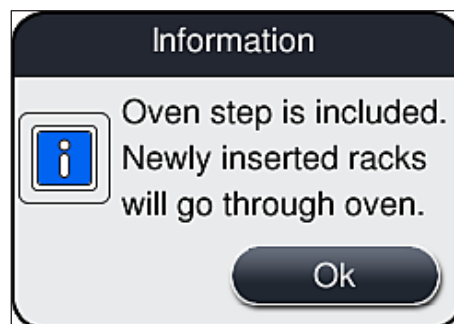

Fig. 37

**Note**

- The function is valid only for racks inserted into the instrument after the **Save** button was pressed.
- The overall processing is extended by the duration of the oven step (approx. 5 min.).

The respective status of the oven is displayed in the status bar (→ Fig. 20):



The oven is in the heating phase



The oven is enabled and ready to operate

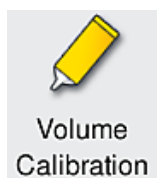

The oven is disabled

5.8.6 Volume calibration

Required access level: Supervisor

The application quantity of the mounting medium on the slide can be adapted to changes in ambient conditions by the **Supervisor** using the **Volume Calibration** menu.

The properties of the mounting medium that is used can be changed depending on the ambient conditions. For example, the viscosity changes due to temperature differences. If the mounting medium is stored at a cool temperature and deployed in a cool state in the instrument for use, the viscosity is "tougher" (i.e. more viscous) than with a mounting medium which has already adapted to the ambient temperature. The viscosity has a direct influence on the application quantity of the mounting medium on the slide.

If the application quantity differs during coverslipping so significantly that the user fears a loss of quality, the application quantity can be adjusted separately for both coverslip lines by means of the **Volume Calibration** menu. The application quantity configured in the parameter sets can remain unchanged.

**Note**

To adjust the application quantity, the password-protected **Supervisor Mode** is necessary. Furthermore, the adjustment is only possible if no processing is running and there are no longer any racks in the instrument.

Adjusting the application quantity by the **Supervisor**

1. Call up the **Settings** menu (→ Fig. 29-1) and press **Volume calibration**.
2. You can adjust the application quantity by turning the corresponding roller (→ Fig. 38-2) for coverslip line **L1** or **L2** (→ Fig. 38-1).

**Note**

Negative values (-1 through -5) reduce the application quantity for the selected coverslip line incrementally, while positive values (1 through 5) increase the application quantity incrementally.

5 Operation

3. To apply the configured values, press the **Save** (→ Fig. 38-3) button for the respective coverslip line, **L1** or **L2**.
4. Note the subsequent information message and acknowledge it with **Ok** (→ Fig. 38-4).
5. Exit the menu by pressing the **Back** (→ Fig. 38-5) button.
6. To discard the settings, do not press the **Save** (→ Fig. 38-3) button, but instead press **Back** (→ Fig. 38-5) and exit the menu without saving.

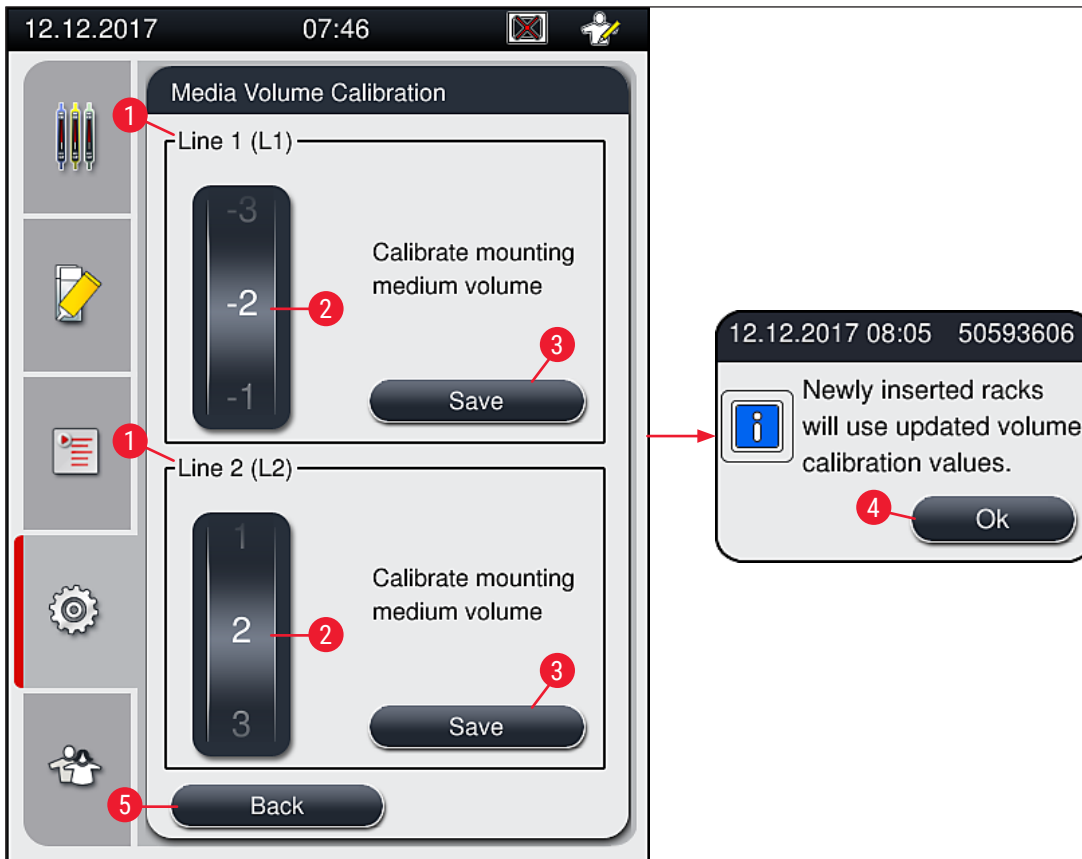
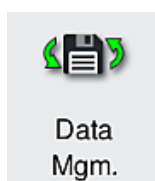

Fig. 38

5.8.7 Data management



Required access level: Standard user, supervisor

- Standard users can execute the **User Export** (→ Fig. 39-1) and **Service Export** (→ Fig. 39-2) functions.
- The **Import** (→ Fig. 39-3) and **SW Update** (→ Fig. 39-4) functions can only be used by the Supervisor.

The event logs (log files) can be exported in this menu. A USB memory stick connected to the USB port on the front side of the instrument (→ Fig. 1-7) is required for all exports and imports.

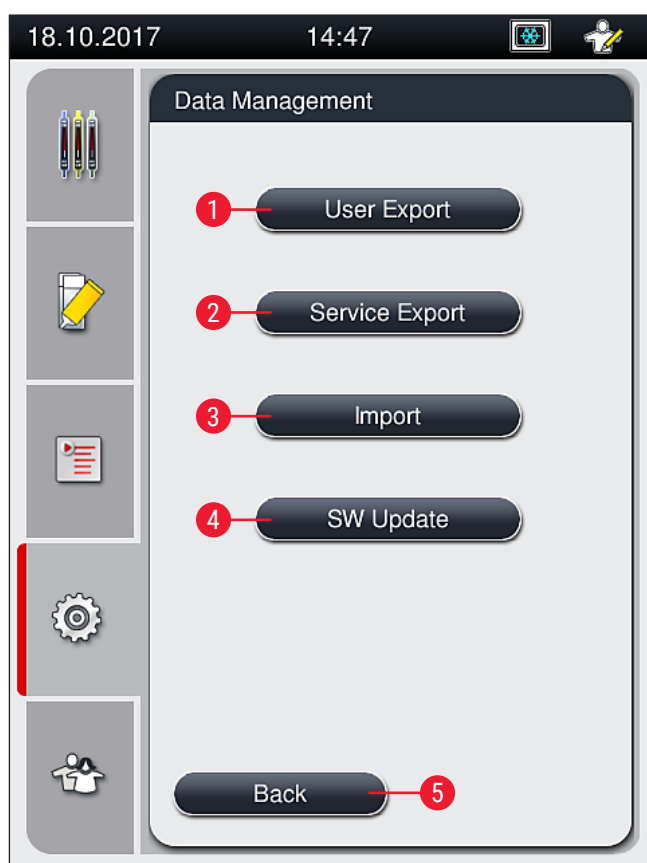

Fig. 39



Note

- The **User Export**, **Service Export**, **Import** and **SW Update** functions can only be carried out if the instrument is in idle mode and there are no longer any racks in the instrument. Furthermore, the load and unload drawers must be closed.
- The USB memory stick used must be formatted as FAT32.
- If a USB memory stick is not recognized by the instrument, please insert it into the second USB socket. If the USB memory stick is still not recognized in the second USB socket, it might be damaged or unreadable by the HistoCore SPECTRA CV. In this case, we recommend using a different USB memory stick formatted in FAT32.

5 Operation

User export (→ Fig. 39-1)

The **User Export** function is used to save information on a connected USB memory stick (→ Fig. 1-7):

- A **zip** file with the event logs of the last 30 working days and CMS information in CSV format.
- An encrypted **lpkg** file that contains all user-defined parameter sets and the consumables list.



Note

The encrypted **lpkg** file cannot be opened and viewed by the user.

1. After pressing the **User Export** button, the data is exported to the connected USB memory stick.
2. The information message **User data is being exported...** is displayed for the duration of the data export.

- ✓ The information message **Export successful** indicates to the user that the data transfer is finished and the USB memory stick can be removed safely. Press the **OK** button to close the message.



Note

If the message **Export failed** is displayed, an error occurred (e.g. the USB memory stick was removed too soon). In this case, the export process must be carried out again.

Service export (→ Fig. 39-2)

The **Service Export** function is used to save a **lpkg** file on a connected USB memory stick (→ Fig. 1-7).

The encrypted **lpkg** file contains a predefined number of event logs as well as the following:

- CMS information
- User-defined parameter sets
- Consumables data
- Additional service-relevant data



Note

The data is stored in encrypted form and can only be decrypted by a Leica service technician.

- After pressing the **Service export** button, a selection menu appears in which the user can select the desired number of data records to be exported (5, 10, 15 or 30 days).
- Press **Ok** to confirm the selection.
- The information message **Service data is being exported...** is displayed for the duration of the data export.
- The information message **Export successful** indicates to the user that the data transfer is finished and the USB memory stick can be removed safely.
- If the message **Export failed** is displayed, an error occurred (e.g. the USB memory stick was removed too soon). In this case, the export process must be carried out again.

Import (→ Fig. 39-3)**Note**

The password-protected **Supervisor Mode** is required for importing.

- ① The function enables the import of language packages from a connected USB memory stick.
 1. To do this, insert the USB memory stick into one of the USB ports on the front side of the instrument.
 2. Then, select the **Import** function. The data is scanned.

SW update (→ Fig. 39-4)

Software updates can be run by a **Supervisor** or by a Leica-authorized service technician.

**Note**

Lab-specific settings are not deleted when updating the software for the HistoCore SPECTRA CV.

5.8.8 Event view

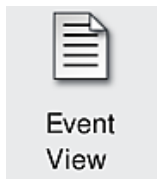

Required access level: Standard user, supervisor

A separate log file is created for each day that the instrument was switched on. This file can be called up by selecting the **DailyRunLog** file in the **Event view** menu (→ Fig. 40).

In the **Event View** menu, an event log (→ Fig. 40) can be selected from a list of available logs (→ Fig. 40-1) and called up by pressing the **Open** (→ Fig. 40-2) button.



Note

The file name is supplemented by adding the respective creation date in ISO format, which makes organization easier. The file is created in the configured language.

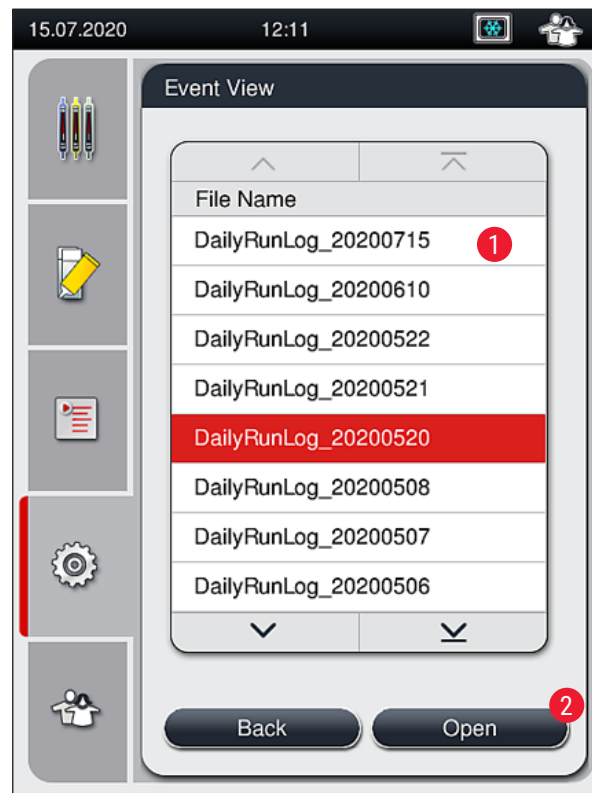

Fig. 40

- All event entries begin with the **Timestamp** (→ Fig. 41-1), a date and time when the entry was created.
- The title bars of the event viewer also indicate the serial number (→ Fig. 41-2) and the currently installed software version (→ Fig. 41-3) of HistoCore SPECTRA CV.
- You can scroll up and down in the list and the log file using the arrow buttons (→ Fig. 41-4).
- Pressing the left button allows you to scroll through the event viewer page by page.
- Pressing the right button takes you to the beginning or the end of the event viewer.
- Entries in the **Event Viewer** are highlighted in different colors to enable the user to quickly identify critical messages. Tapping on an entry in the list will show the specific message on the display.

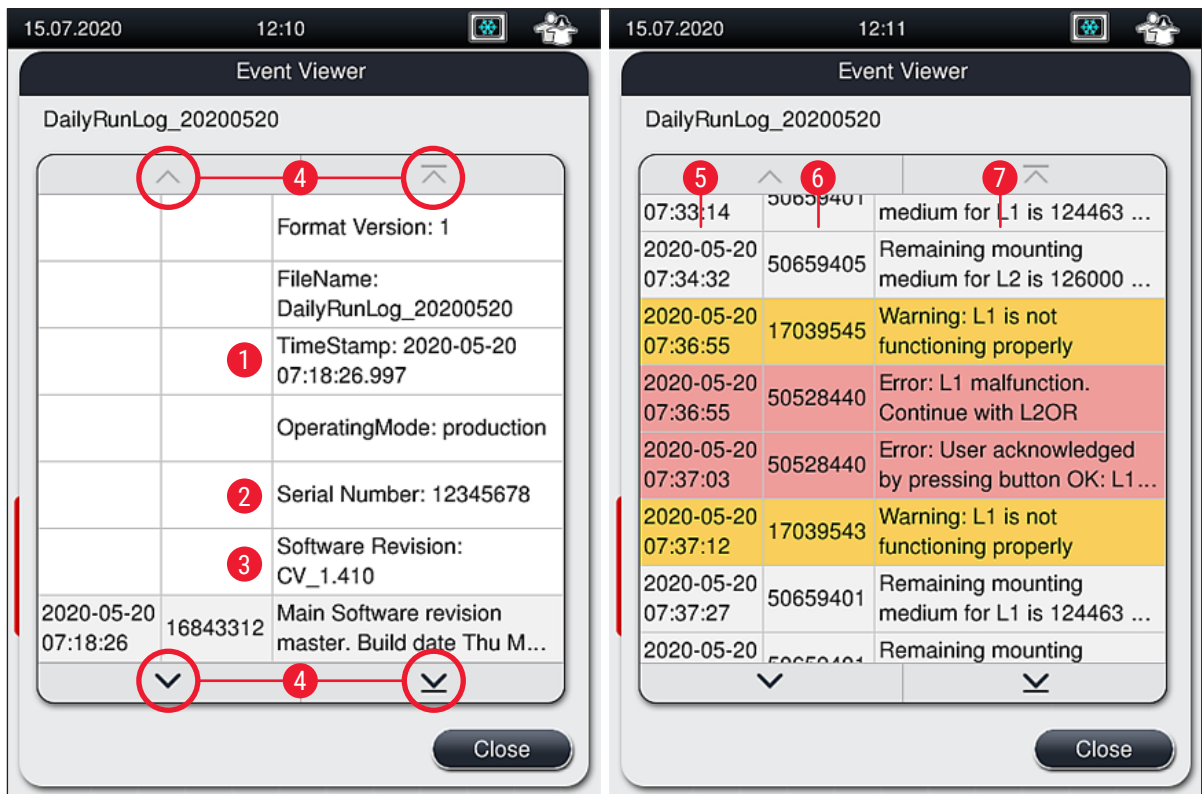

Fig. 41

- | | | | |
|------------|----------------------------|---------------|-----------------------------------|
| 1+5 | Time stamp | 4 | Arrow buttons |
| 2 | Serial number | 6 | Event ID |
| 3 | Installed Software version | 7 | Message |
| | | Color: Gray | Indicates an event or information |
| | | Color: Orange | Indicates a warning message |
| | | Color: Red | Indicates an error message |

5 Operation

5.9 Parameter settings



Note

- The parameter set menu (→ Fig. 42) lets the user create new parameter sets, modify existing ones or assign a rack handle color to a parameter set. Creating or modifying a parameter set requires having the **Supervisor** user status and is only possible if there is no rack in the instrument and the instrument is idle.
- The **User** status only allows one parameter set to be displayed.

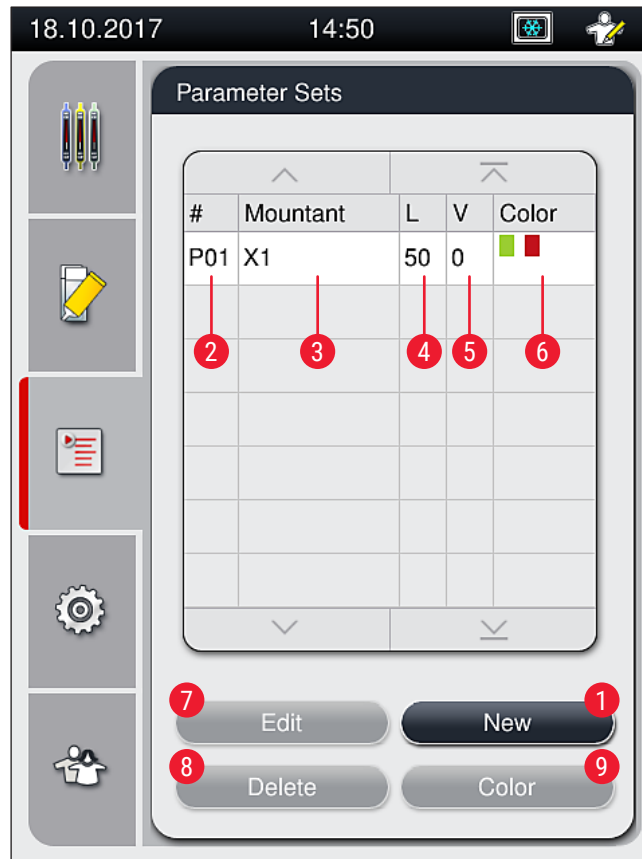

Fig. 42

- | | | | |
|---|----------------------------|---|-------------------------------------|
| 1 | Create a new parameter set | 6 | Assigned rack handle color(s) |
| 2 | Parameter set number | 7 | Editing a parameter set |
| 3 | Mounting medium used | 8 | Deleting a parameter set |
| 4 | Coverglass length | 9 | Assigning colors to a parameter set |
| 5 | Application volume | | |

5.9.1 Creating a new parameter set

1. To create a new parameter set, press the **New** button (→ Fig. 42-1) in the parameter set menu.
 2. In the following open menu, an incremental adjustment of the application volume (max. 25/min. -5) can take place (→ P. 71 – 5.9.5 Adjustment of the application volume). For this purpose set the desired volume by turning the roller (→ Fig. 43-1).
 3. Finally press the **Save** button (→ Fig. 43-2).
- ✓ The newly created parameter set is now saved and can be selected in the parameter set menu (→ Fig. 42).
- ⓘ To discard the parameter set, press the **Cancel** (→ Fig. 43-3) button.



Fig. 43

5.9.2 Assigning a parameter set to a rack handle color



Note

One or more rack handle color(s) can be assigned to each parameter set. For this purpose the **Supervisor** user status is required.

1. In the parameter set menu (→ Fig. 44), tap on the corresponding entry to select the parameter set to which a rack handle color is to be assigned (→ Fig. 44-1).
2. Pressing the **Color** (→ Fig. 44-2) button displays a selection field (→ Fig. 45), that allows the assignment of the rack handle color to the selected parameter set.

5 Operation



Note

The following must be taken into account when creating a parameter set when the workstation is working:

- If slides in HistoCore SPECTRA ST are processed with a program, which was allocated a specific color (for example green), the user has to pay attention that the same color is assigned to the suitable parameter set in HistoCore SPECTRA CV which was created and is startable.

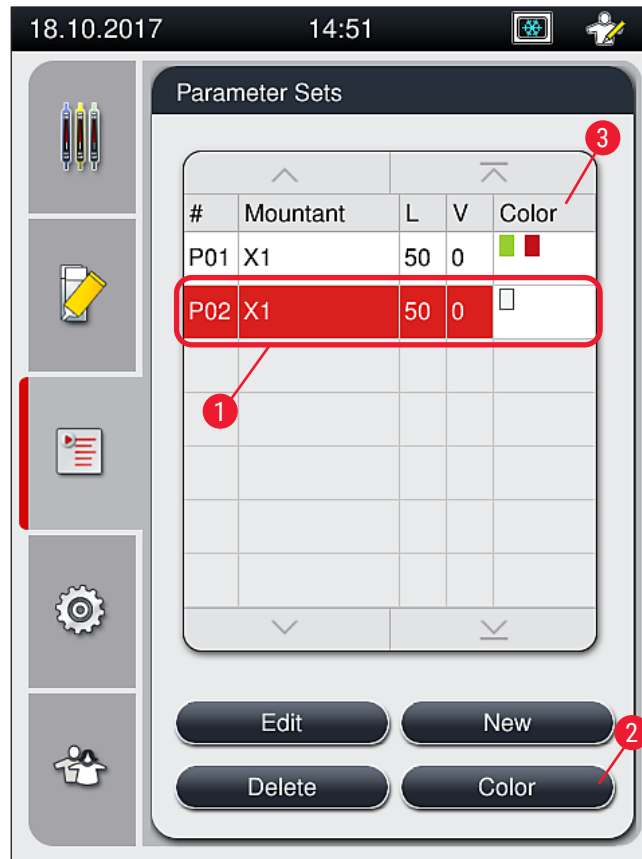

Fig. 44



Note

- All available colors are displayed in Figure (→ Fig. 45). If an abbreviation is entered in the color field, this color has already been assigned to a parameter set.
- If an already assigned color is selected, a dialog box appears with a confirmation prompt indicating that the existing assignment will be undone. This can be confirmed with **OK** or canceled with **Cancel**.

3. In the overview (→ Fig. 45-1), select a color that has not been assigned previously.
4. **Save** (→ Fig. 45-2) is used to assign the color and close the dialog.
 - ✓ The selected color is now displayed in the parameter set list.
- ① **Cancel** (→ Fig. 45-3) is used to close the dialog without applying the changes.



Fig. 45

**Note**

The color white is a wildcard color. When inserting a rack with a white handle, a selection window opens that has to be used to assign a unique parameter set to the white handle. Assigning the color white to a parameter set removes all colors previously assigned to that parameter set.

5.9.3 Properties of the mounting medium



Note

Leica provides validated mounting media for the HistoCore SPECTRA CV. This offers the user the following advantages:

- Easy handling and non-contact filling and/or changing of the mounting medium
- Low defect rate
- Closed system
- Fully automated importing of relevant data (designation, LOT numbers, number of possible coverslipping operations remaining) into CMS,
- Graphical fill level display and monitoring.

Designation	Viscosity	Drying time	Based on...
X1*	Low	Approx. 24 hours	Xylene, Toluene

*Ordering information: ([→ P. 158 – Consumables](#))



Note

- Please observe the procedure when filling the mounting medium for the first time ([→ P. 32 – 4.6 Refilling consumables](#)).
- Changing the mounting medium is described in ([→ P. 79 – 6.3.1 Changing the mounting medium bottle](#)).

5.9.4 Properties of the coverglass

Leica offers coverglass for the HistoCore SPECTRA CV, validated and manufactured in accordance with the ISO Standard 8255-1, 2011 ([→ P. 19 – 3.2 Technical data](#)).

The Consumables Management System (CMS) automatically detects refilling and shows the current level of the coverglasses at all times.

Only Leica coverglass* can be used in the HistoCore SPECTRA CV:

Length in mm	Width in mm	Thickness
50	24	#1

*Ordering information: ([→ P. 158 – Consumables](#))



Note

A change in the device allows the use of clipped corner slides. This change must only be made by a Leica service technician. In combination with the new setting, the use of large labels on the labeling field is not recommended for quality reasons!

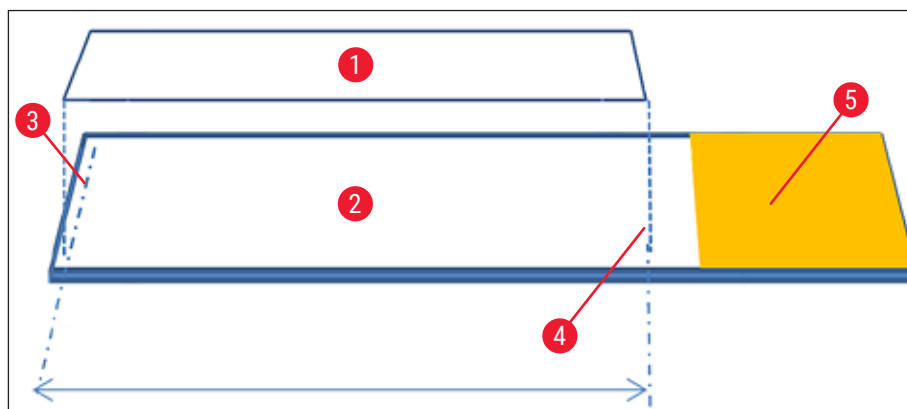

Fig. 46

- 1 Coverglass size: 50 mm
- 2 Slides
- 3 Edge position of the coverglass on the slide
- 4 Position on the slide, coverglass size of 50 mm
- 5 Label field of the slide

5.9.5 Adjustment of the application volume

The HistoCore SPECTRA CV has a volume setting for the application volume of the mounting medium that is set by default and validated by Leica. The default values are defined as **0** (=default) in the setting for the parameter set (→ Fig. 47-1). These settings can be used immediately.



Note

Leica recommends checking the 0 value under the given conditions and requirements (e.g. specimen size, specimen type and specimen thickness, temperature and humidity) in the lab and adjusting it where appropriate.

1. To adjust the application volume, select the corresponding parameter set in the **Parameter sets** menu and press the **Edit** button (→ Fig. 42-7).
2. In the following menu (→ Fig. 47) the application volume can be lowered or increased by turning the roller (→ Fig. 47-1).
3. The menu also offers the option of changing an assigned color (→ Fig. 47-2) or to assign a new color (→ P. 67 – 5.9.2 Assigning a parameter set to a rack handle color).
4. Apply the settings you have entered by pressing the **Save** button (→ Fig. 47-3) or press **Cancel** (→ Fig. 47-4) to return to the **Parameter sets** menu without saving.



Fig. 47

Set value	Significance
Default value 0	Apply the Leica-validated quantity of mounting medium to the slide.
Positive values 1 to 5 in 1-step increments	Slightly more mounting medium is applied incrementally to the slide.
Positive values 5 to 25 in 5-step increments	Larger amounts of mounting medium are applied incrementally to the slide.
Negative values -1 to -5 in 1-step increments	Less mounting medium is applied incrementally to the slide.



Warning

- Changes to the mounting medium application quantity should only be made with extreme caution to prevent negative effects on the coverslipping result.
- The set values of positive 5 to 25 should only be used with caution. Those values are only for very uneven, thicker specimens or cytology smears.
- Higher amounts of applied mounting medium could lead to oozing and contamination of the coverslip line with mounting medium. Therefore, a greater cleaning effort might be necessary. Also the ratio of coverslipped slides per bottle will be smaller if these higher set values are used.

5.10 Reagent vessels in the load drawer



Warning

- It is absolutely necessary to ensure that the reagent filled in the reagent vessel is compatible with the mounting medium!
- The user must monitor the levels of the reagent vessels to ensure they are sufficient.
- If the instrument is to be in a non-running state for a moderate period of time or if the HistoCore SPECTRA CV is not to be used for a long period of time (longer than 5 days), cover or empty the reagent vessels in the load drawer in order to prevent evaporation of the filled reagent and to prevent the formation of vapors.
- If the HistoCore SPECTRA CV is used in conjunction with the HistoCore SPECTRA ST as a workstation, the user must ensure that the last stations in the staining program of the HistoCore SPECTRA ST are filled with the same reagent as the load stations of the HistoCore SPECTRA CV.

- Racks newly inserted into the load drawer are detected after closing the load drawer and displayed in the according color (→ Fig. 48-1).

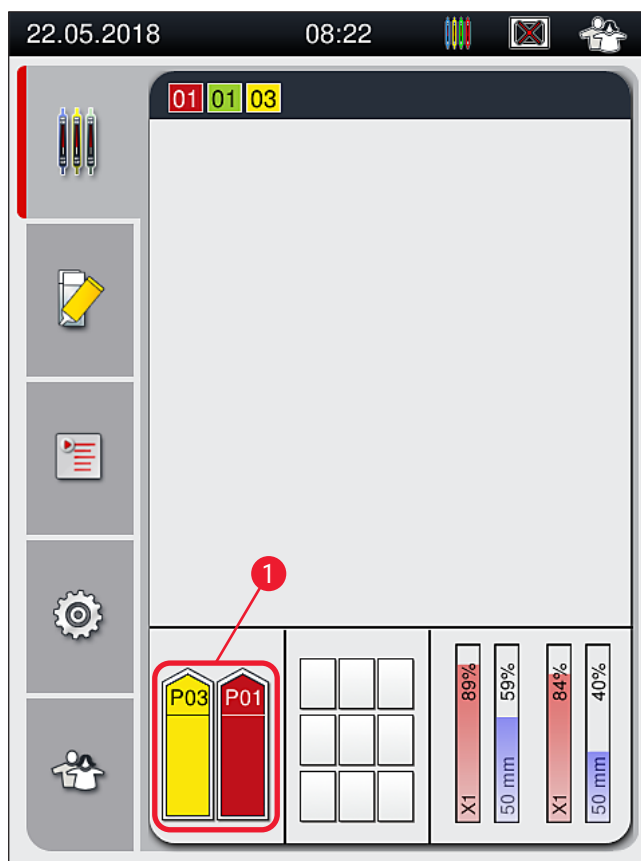

Fig. 48

- At the same time, the instrument checks whether the parameter set assigned to the rack handle color matches the mounting medium and coverslip size present in the coverslip line.
- If this is not the case, a message prompts the user to take the rack back out of the load drawer and to place it in the other reagent vessel in the load drawer.

5 Operation

- The instrument detects if a rack with a rack handle that has an unassigned color is inserted in either of the two reagent vessels. The user is prompted to take the rack back out and to create a corresponding parameter set (→ P. 67 – 5.9.1 Creating a new parameter set) or to assign the color to an appropriate existing parameter set (→ P. 67 – 5.9.2 Assigning a parameter set to a rack handle color).

5.11 Module status

- The menu **Module Status** (→ Fig. 49) provides the user in HistoCore SPECTRA CV an overview of the used consumables (mounting media (→ Fig. 49-1) and coverglass (→ Fig. 49-3)) and their current fill levels (→ Fig. 49-5) (→ Fig. 49-6) and remaining amounts (→ Fig. 49-2) (→ Fig. 49-4) for both coverslip lines.
- The user has access to various cleaning options for the hose system through the **Prime/Clean** submenu (→ Fig. 49-7).

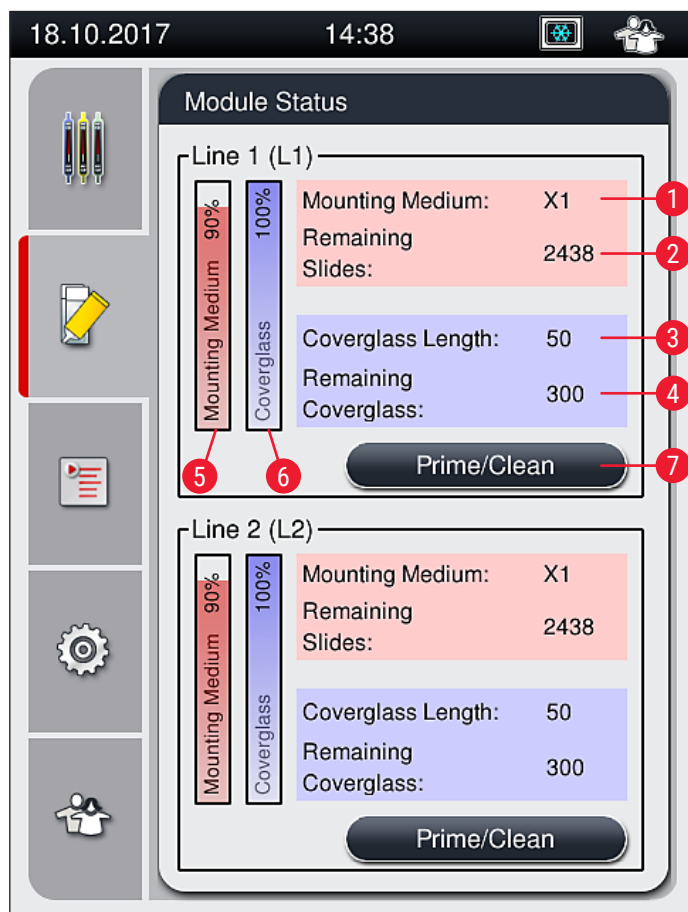

Fig. 49

1	Mounting medium name	5	Remaining amount of mounting medium in %
2	Remaining number of slides	6	Remaining amount of coverglasses in %
3	Coverglass length	7	Prime/Clean submenu
4	Remaining number of coverglass		

**Note**

For more information about the **Prime/Clean** submenu and using the individual priming and cleaning options: (→ P. 119 – 7.3 Preparing the hose system for priming and cleaning).

6 Daily Instrument Setup

6. Daily Instrument Setup

6.1 Station overview

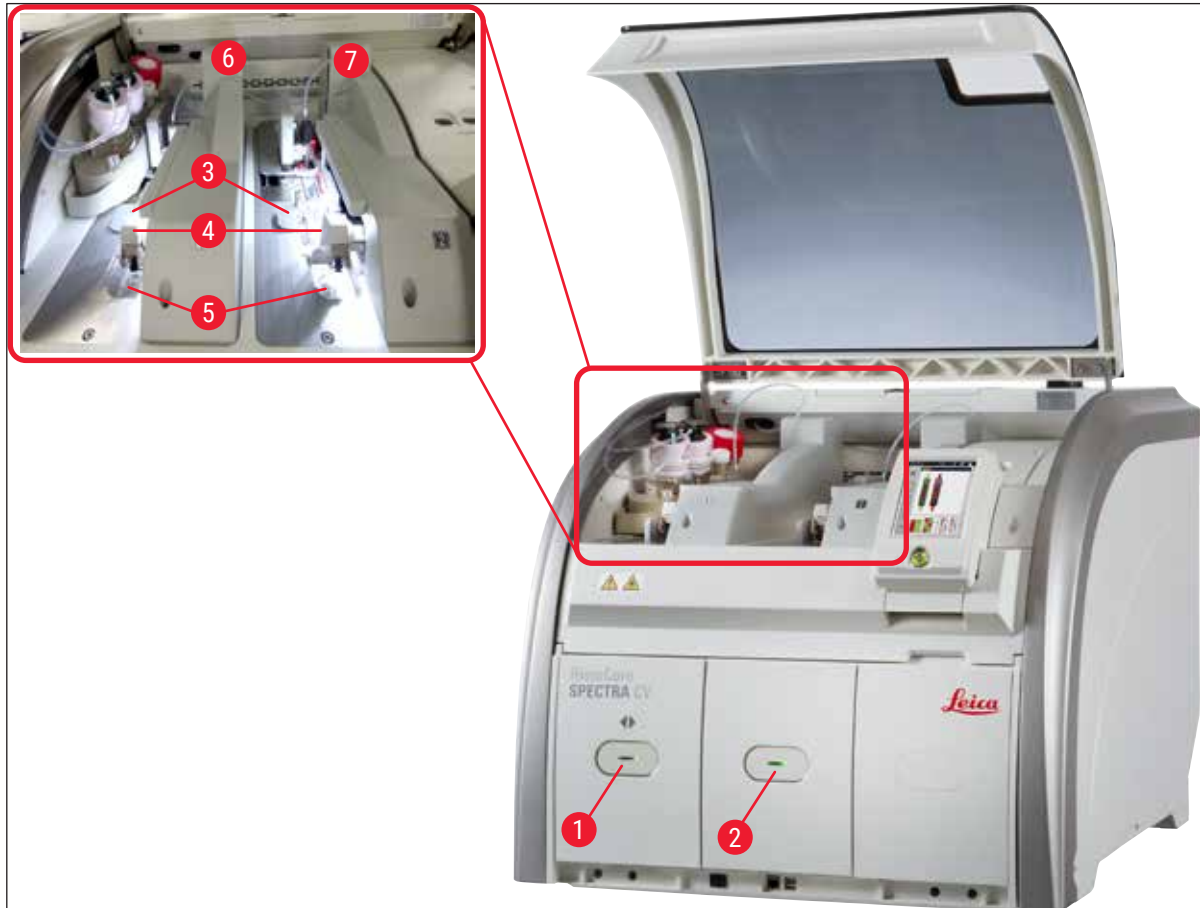

Fig. 50

1	Load drawer	5	Waste tray
2	Unload drawer	6	Left coverslip line <u>L1</u>
3	Coverglass cartridge	7	Right coverslip line <u>L2</u>
4	Pick&Place module		



Warning

- The system does not monitor the fill level of the reagent vessels in the load drawer (→ Fig. 50-1). The user is responsible for monitoring.
- Before the daily instrument setup, ensure that the covers of the reagent vessels in the load drawer were removed and the drawer inserts are correctly inserted in the unload drawer (→ Fig. 8-1).

6.2 Switching on and shutting down the instrument

Switching on the instrument

1. To start the instrument, press the **Operating switch** (→ Fig. 52-1) illuminated in red.
 2. During initialization, a verification of all modules and consumables is carried out automatically.
- ✓ The **Operating switch** (→ Fig. 52-1) is illuminated in green whenever the instrument is ready to start.
- ① After completing the initialization phase, the main menu (→ Fig. 19) appears on the screen. and the user is informed (→ Fig. 51) that a **Quick Prime** is required for the coverslip line in use. Acknowledge the messages by pressing **Ok** (→ Fig. 51-1) and follow the instructions that follow (→ P. 119 – 7.3 Preparing the hose system for priming and cleaning).

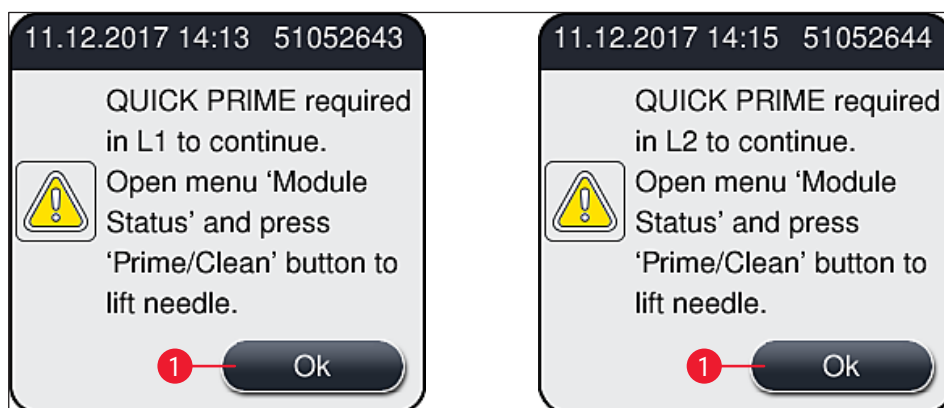

Fig. 51

Shutting down the instrument

1. To switch the instrument into standby mode (e.g. overnight), press the **Operating switch** twice. It then illuminates in red (→ Fig. 52-1).



Fig. 52

- ① For cleaning and maintenance, observe the notes in (→ P. 106 – 7.1 Important notes about cleaning this instrument).

6.3 Checking and refilling consumables

During initialization of the instrument, the consumables (mounting medium, coverglass, fill level of the needle cleaning container) are checked automatically (→ P. 43 – 5.4 Consumables Management System (CMS)).

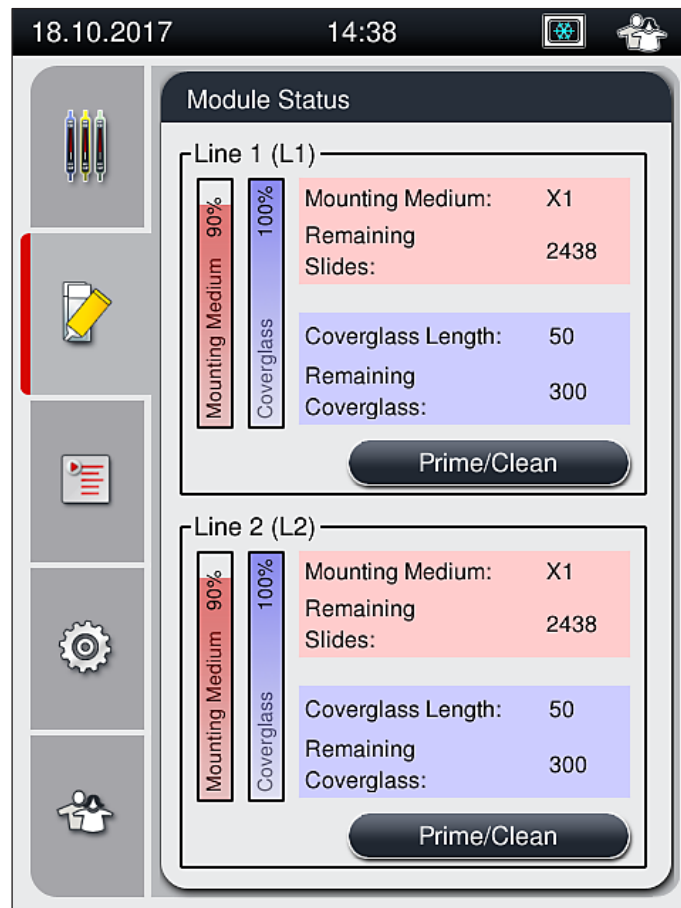

Fig. 53

- If a consumable is used up, a corresponding warning message is sent to the user, for example (→ Fig. 54).

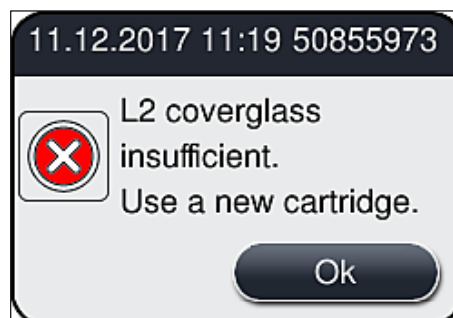

Fig. 54

**Note**

In the event that there is insufficient mounting medium available in order to fill the hose after initialization, a new mounting medium bottle must be inserted by the user (→ P. 79 – 6.3.1 Changing the mounting medium bottle).

- To avoid air bubbles in the system, prime the system after initialization of the instrument (→ P. 122 – 7.3.1 Quick Prime).

6.3.1 Changing the mounting medium bottle**Warning**

- While changing the mounting medium bottle, always wear personal protective clothing (lab coat, cut-resistant gloves, safety goggles)!
- The mounting medium may be only used a maximum of 14 days in the instrument and must be exchanged after this period to avoid a deterioration of the coverslip results.
- Before the insertion of a mounting medium bottle in the instrument, the expiration date (imprint on the packaging and on the bottle label (→ Fig. 15-3)) is to be checked. If the expiration date has been reached or exceeded, the mounting medium may no longer be used. Expired mounting medium is to be disposed of in accordance with the applicable on-site lab guidelines.
- Avoid a delay while changing the mounting medium bottle in order to prevent the cannula from becoming stuck. Thus, do not leave the cannula in the park position longer than necessary.

**Note**

- Changing the mounting medium bottle in the **L2** coverslip line is described in the following. The same procedures also apply for the coverslip line **L1**.
- When changing the mounting medium bottle, we recommend that you wait if possible until there are no longer any slides in processing in either coverslip line and the instrument is in idle mode, in order to prevent the specimens from drying out.

- For each inserted rack, the consumable management system (CMS) calculates whether the available quantity of mounting medium is sufficient.
- If there is a rack in processing and the CMS determines that the remaining quantity of mounting medium is no longer sufficient for a newly placed rack, the CMS indicates to the user (→ Fig. 55-1) that a new mounting medium bottle must be inserted upon completion of the rack currently being processed in the instrument.
- If the CMS determines that a newly inserted rack can no longer be completely coverslipped, an appropriate warning message (→ Fig. 55-2) will be displayed to the user.

6 Daily Instrument Setup

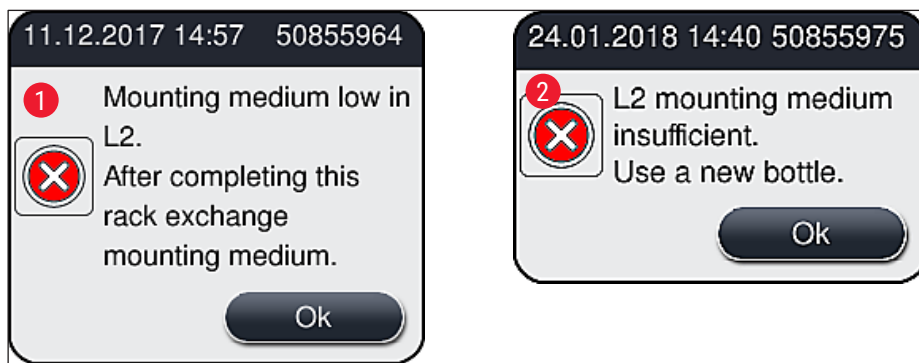

Fig. 55



Note

New processing in the **L2** (→ P. 123 – 7.3.2 Extended Prime) coverslip line is only possible after the insertion of a new mounting medium bottle and the necessary extended priming.

To change the mounting medium bottle, proceed as follows:

1. Open the hood (→ Fig. 1-1).
2. Grasp the bottle sledge on the handle and move it forwards (→ Fig. 56-1).
3. Carefully withdraw the cannula (→ Fig. 56-2) **L2** from the mounting medium bottle opening and place in the parking location (→ Fig. 56-3).
4. Remove the empty mounting medium bottle (→ Fig. 56-4) and dispose of it in accordance with the laboratory specifications.

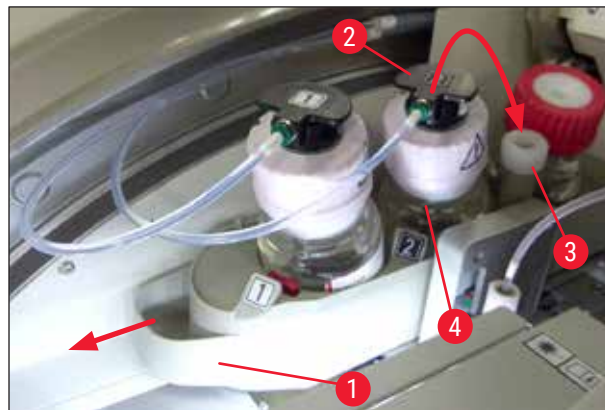

Fig. 56

5. Take a new mounting medium bottle (→ Fig. 57) out of the packaging and remove the black plastic cap (→ Fig. 57-1).



Warning

Do not remove the white protective foil (→ Fig. 57-2). It must remain on the bottle.



Fig. 57

6. Insert the new mounting medium bottle (→ Fig. 58-1) into the **L2** slot (→ Fig. 58-2) in the bottle sledge and make sure that the RFID chip attached to the bottle is seated in the notch of the slot (→ Fig. 58-3).
7. Take the cannula with the label **2** (→ Fig. 58-4) out of the parking location (→ Fig. 58-5) and carefully insert into the opening of the mounting medium bottle (→ Fig. 58-6) until it noticeably clicks into place (→ Fig. 58-7). In the course of this, the white protective membrane of the bottle is punctured.

**Note**

Before inserting the drain tube into the new mounting medium bottle, check the cannula for any dried mounting medium residue and, if necessary, moisten with xylene and clean with a lint-free cloth.



Fig. 58

**Warning**

Puncturing the white protective membrane briefly requires an increase in force. Therefore, proceed carefully to avoid letting it slip from your hand and to avoid bending the cannula.

8. Slide the bottle sledge (→ Fig. 56-1) back into its original position once again until it clicks into place.
9. Close the hood.
10. The mounting medium bottles that are reinserted are detected by the instrument software and the **Module Status** (→ Fig. 53) is updated.



Note

The CMS detects that a new mounting medium bottle has been inserted, and informs the user that an Extended Prime is required for the coverslip line **L2** (→ P. 123 – 7.3.2 Extended Prime). By this means, air and any old mounting medium that is possibly still present is ousted from the hose system. Only afterwards is the instrument ready to start.

6.3.2 Monitoring and refilling of the needle cleaning container



Note

The HistoCore SPECTRA CV has an automatic fill level scan mechanism in the needle cleaning container. A warning message informs the user if there is not a sufficient quantity of xylene left in the glass vessel. Despite the automated fill level scan, Leica recommends also carrying out a visual inspection during daily startup to ensure that no refilling is necessary during daily routine work.



Warning

The warning messages in (→ P. 32 – 4.6 Refilling consumables) must be observed when handling solvents like xylene!

1. Select the **Module Status** (→ P. 74 – 5.11 Module status) menu in the main menu and press the **Prime/Clean** button in the desired coverslip line.
2. The needle moves automatically to the maintenance position.
3. Open the hood.
4. Take the needle out of the holder sideways and place it in the prime bottle (→ Fig. 3-11).
5. Turn the knurled screw (→ Fig. 59-1) clockwise to lift the needle cleaning container.
6. The needle cleaning container (→ Fig. 59-2) is lifted upwards and can be removed (→ Fig. 59-3).
7. Dispose remaining xylene in the needle cleaning container according to the laboratory regulations.
8. Outside of the instrument, use a Pasteur pipette to fill xylene into the glass cylinder (→ Fig. 59-4) up to the edge of the plastic cap (approx. 10 ml).
9. Following this, put the needle cleaning container back into the correct position within the instrument once again and push it completely in.
10. Take the needle out of the prime bottle and reinsert it into the holder.
11. In the Maintenance menu, press the **Close** button.
12. Close the hood.
13. The needle is automatically immersed in the needle cleaning container.

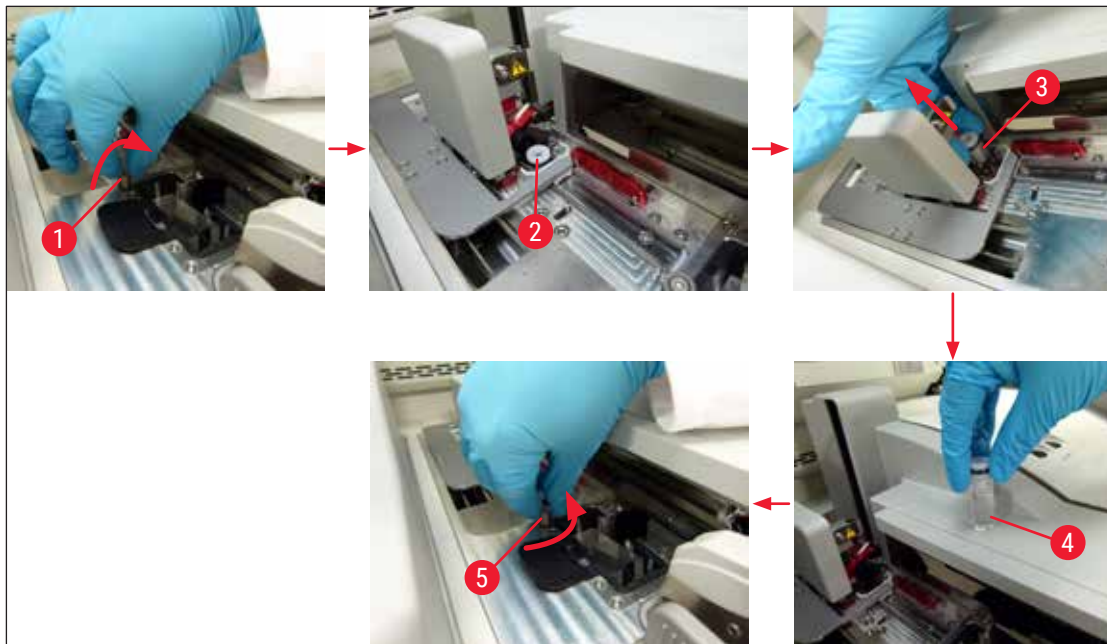

Fig. 59

6.3.3 Checking and replacing the coverglass cartridge



Warning

While changing the coverglass cartridge, always wear personal protective clothing (cut-resistant gloves, safety goggles)!



Note

- For the HistoCore SPECTRA CV Leica-validated coverglass (→ P. 158 – Consumables) are available. The coverglasses are only available in cartridges which are equipped with a RFID chip. Information on the cartridge used (e.g. quantity and size) is automatically read when it is inserted and the hood is closed.
 - Changing the coverglass cartridge in the **L2** coverslip line is described in the following. The same procedures also apply for the coverslip line **L1**.
- For each newly inserted rack, the consumable management system (CMS) calculates whether the available quantity of coverglass in the magazine is sufficient.
 - If the CMS determines that a newly inserted rack can no longer be completely coverslipped, an appropriate warning message (→ Fig. 60-1) will be displayed to the user.
 - If there is a rack located in the load drawer, or if one is to be placed there, the CMS indicates to the user that a new coverglass cartridge must be inserted (→ Fig. 60-2).

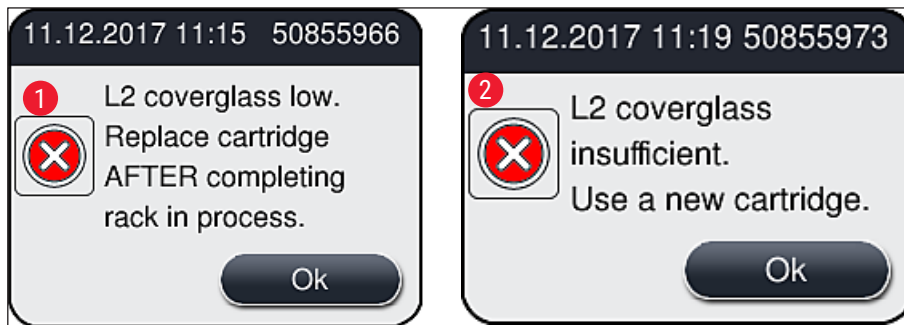

Fig. 60

**Note**

New processing in the **L2** coverslip line is only possible after the insertion of a new coverglass cartridge.

To change the coverglass cartridge, proceed as follows:

1. Open the hood.
2. The Pick&Place module (→ Fig. 61-1) is located above the waste tray (→ Fig. 61-2).
3. Remove the coverglass cartridge (→ Fig. 61-3) that is present in the instrument from the slot for the cartridge (→ Fig. 61-4).

**Note**

- If there are still coverglass present in the magazine, up to 30 slip of remaining cover glass can be inserted in the new coverglass cartridge. These are added on to the new coverglass cartridge and displayed in the Module Status.
- Ensure that the coverglass is inserted correctly in the magazine (→ Fig. 64).

4. Dispose of the empty coverglass cartridge in accordance with the laboratory regulations.



Fig. 61

5. Unpack a new coverglass cartridge (→ Fig. 62-1) and remove both the transport anchor (→ Fig. 62-2) and the silica gel packet (→ Fig. 13-3).
6. Insert the new coverglass cartridge into the slot for the coverglass cartridge (→ Fig. 62-3).

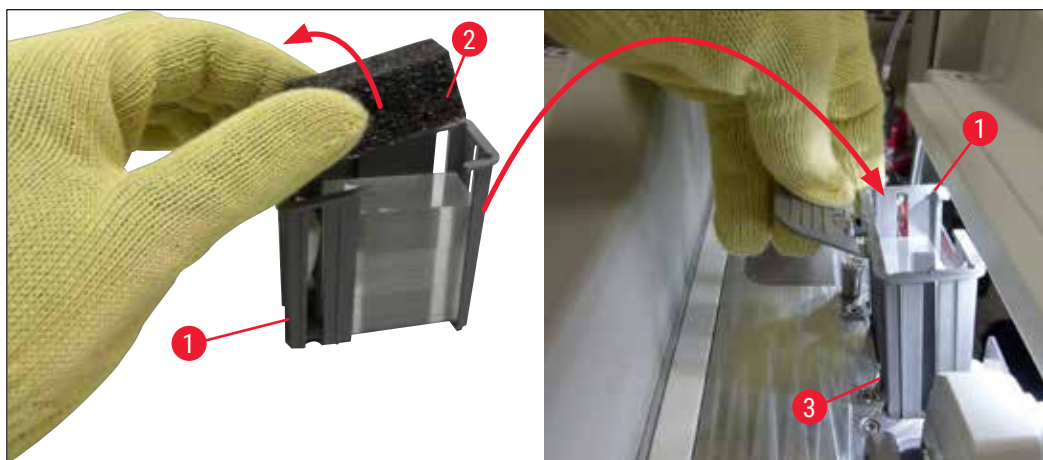

Fig. 62

7. Close the instrument hood.
8. After closing the hood, the user is questioned as to whether the remaining coverglass have been inserted into the new coverglass cartridge (→ Fig. 63). If this is the case, acknowledge the information message with **Yes** (→ Fig. 63-1). If no coverglass have been inserted, acknowledge the information message with **No** (→ Fig. 63-2).

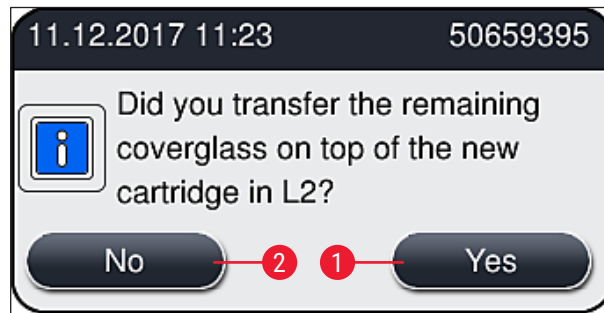

Fig. 63

- ✓ The data from the new coverglass cartridge is now imported and the **Module Status** is updated.

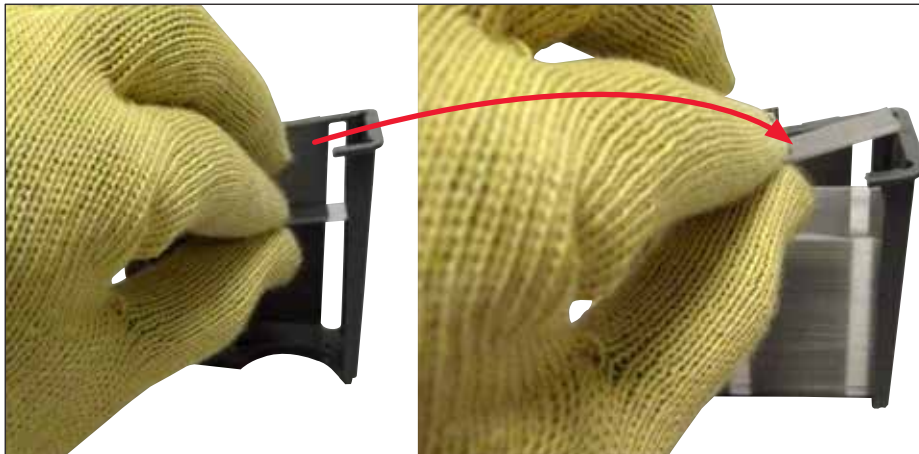

Fig. 64

**Warning**

Wear cut-resistant safety gloves (→ P. 18 – 3.1 Standard delivery – packing list) when inserting additional coverglass!

The maximum filling level of the coverglass cartridge (see marking within the magazine) must not be exceeded in order to prevent instrument faults.

6.3.4 Emptying the waste tray



Note

The HistoCore SPECTRA CV automatically detects defective/broken coverglass and places it in the waste tray.



Warning

Wear cut-resistant safety gloves (→ P. 18 – 3.1 Standard delivery – packing list) for emptying the waste tray!

1. Open the hood.
2. Check the waste tray for broken coverlasses.
3. If broken coverglass exist, remove the waste tray (→ Fig. 65-1) and clean it.
4. Then insert the waste tray back in the position provided for it (→ Fig. 65-2).

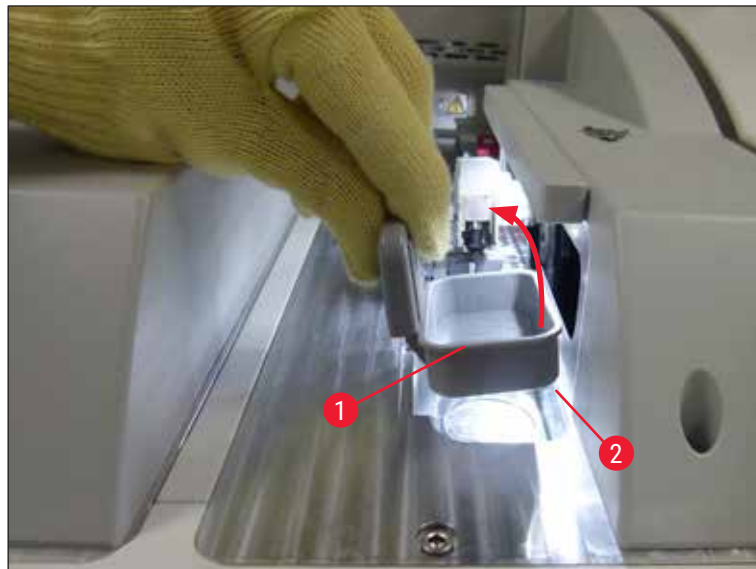

Fig. 65

5. Close the hood again.

6.3.5 Inspect Pick&Place module

1. Open the hood.
2. Check skids (→ Fig. 66-1), suction cups front and rear (→ Fig. 66-2) and coverglass sensor pin (→ Fig. 66-3) for dirt and clean if necessary (→ P. 115 – 7.2.11 Cleaning the Pick&Place module).
3. Close the hood again.

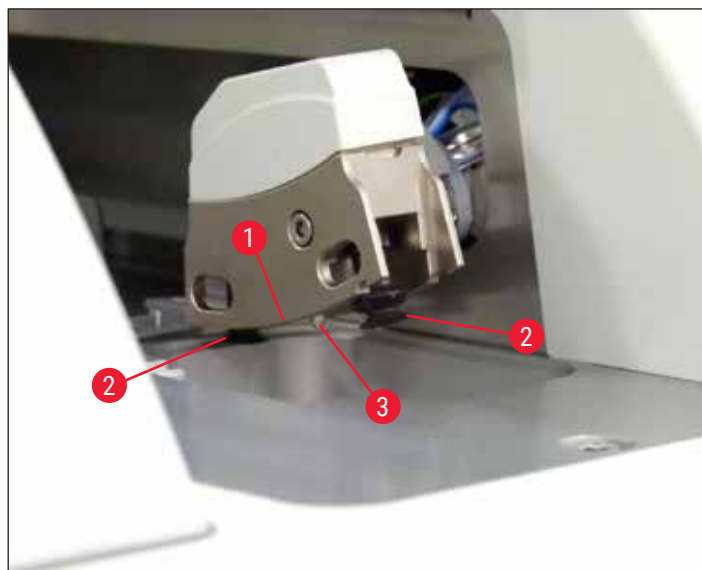

Fig. 66

6.3.6 Load drawer



Warning

The warning messages in (→ P. 32 – 4.6 Refilling consumables) must be observed when handling solvents like xylene!

Fill level check of the reagent vessels in the load drawer

Correct fill level of the reagent vessels

1. To scan the fill level of the reagent vessels, press the drawer button of the load drawer (→ Fig. 50-1).
2. The load drawer opens.
3. If present, remove the cover for the reagent vessel.
4. Check that the fill level is sufficient (→ Fig. 67) and the reagent is free of dirt. In the event of contamination, the xylene is to be replaced (→ P. 37 – 4.6.3 Prepare the reagent vessel, fill it and insert it into the load drawer) and the reagent vessel is to be cleaned before filling it again.



Warning

A reagent vessel fill level that is too low can cause losses in quality during coverslipping.

5. A sufficient filling level is ensured if the level of the reagent is between the maximum (→ Fig. 67-1) and the minimum (→ Fig. 67-2) fill level mark.

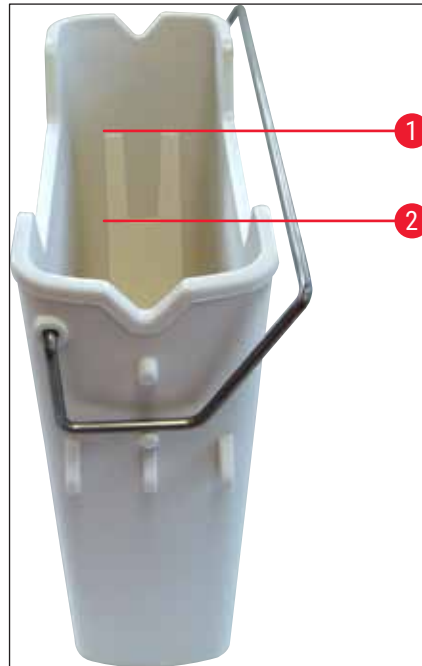

Fig. 67

6. If the filling level is below the minimum mark, the reagent vessel has to be refilled with the same reagent (→ P. 32 – 4.6 Refilling consumables).

**Note**

- Always fill reagent vessels with xylene. Blending with other reagents shall be avoided.
- Cover the reagent vessels at the end of the work day to prevent evaporation of the filled reagent.

6.3.7 Unload drawer

1. Press the drawer button on the unload drawer (→ Fig. 50-2).
2. The unload drawer opens.
3. Remove any racks that may be present in the unload drawer.
4. Perform a visual inspection of the drawer inserts for dirt and clean them if necessary (→ P. 107 – 7.2.3 Load and unload drawers).
5. Then close the drawer by pressing the button.

**Warning**

Wear cut-resistant safety gloves (→ P. 18 – 3.1 Standard delivery – packing list) when cleaning the unload drawer!

6.4 Preparing the rack

**Warning**

Be sure to remove the handle before using the racks in any microwave appliance! Microwaves can destroy the electronics (RFID chip) integrated into the handles, preventing the handles from being identified by the HistoCore SPECTRA CV and HistoCore SPECTRA ST as a result!

For use in the HistoCore SPECTRA CV there are racks for 30 slides (→ Fig. 68-1) with compatible, colored handles (→ Fig. 68-2) (→ P. 153 – 9.1 Optional accessories).

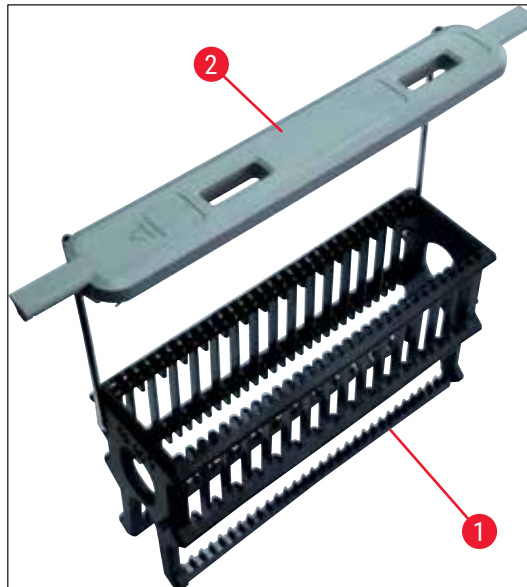

Fig. 68

**Warning**

- Note that in workstation mode (→ P. 102 – 6.7 Workstation operation), the HistoCore SPECTRA CV cannot recognize or process any racks for 5 slides, 20 slides, extra-large slides or racks produced by other manufacturers.
- Only specimen slides that meet the DIN ISO 8037-1 standard can be coverslipped in the HistoCore SPECTRA CV.
- The instrument software detects the manual insertion of racks for 5 slides or 20 slides in the load drawer of the HistoCore SPECTRA CV, and an information message prompts the user to remove this rack again.
- If racks for 5 slides or 20 slides are used for staining in the HistoCore SPECTRA ST, select the unloader as the last station in the program.
- Remove the finished stained slides and insert them into a suitable rack for the HistoCore SPECTRA CV.

The colored handles must be correctly attached prior to using the rack in the instrument (→ Fig. 68-2).

**Note**

Before attaching the colored rack handle, check for any bends or damage. Bent or damaged rack handles must not be used to prevent instrument faults and specimen impairment.

The colored handles of the racks must be attached corresponding to the previously defined parameter set color (→ P. 67 – 5.9.2 Assigning a parameter set to a rack handle color).

The slide handles are available in 9 colors (8 parameter set colors & white) (→ P. 153 – 9.1 Optional accessories).

**Note**

Special function of the white handle:

- The white handle cannot be permanently assigned to a parameter set. Corresponding to a "wildcard function", the white handle has to be reassigned to a parameter set each time the program is used. For this purpose, a selection menu opens on the screen automatically after inserting the rack.

Proceed as follows to attach or replace the rack handles:

Detach the handle from the rack.

1. Slightly pull the handle apart (→ Fig. 69-1) so that the handle wire can be pulled out of the hole in the holder.

Attach a handle to the rack.

- » Lightly pull the handle apart so that the handle wire can snap into the respective holes in the holder.

**Note**

- Be sure that the handle is correctly positioned in the upper position, centered above the rack (→ Fig. 69)
- For stable placement when filling, fold the handle to the side as far as it goes (→ Fig. 69-2) so that it can be used as an additional protection to prevent tipping.

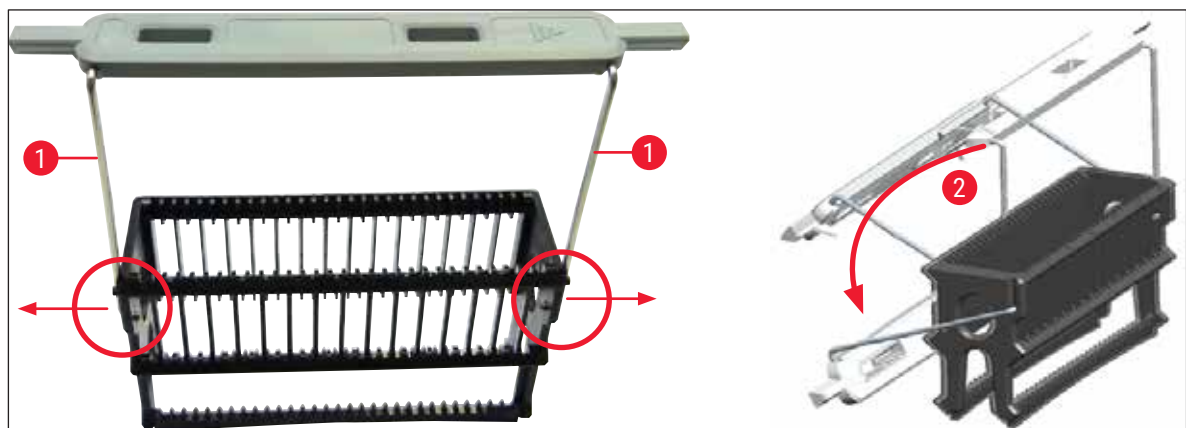

Fig. 69

**Warning**

- The front side of the rack is marked with the **Leica** logo (→ Fig. 70-1). With the handle attached, **Front** can be read when looking at the handle (→ Fig. 70-2).
- When inserting the slides, be absolutely certain that the slide label is pointing upwards and toward the user (→ Fig. 70-3). The side of the slide with the specimen must point toward the front side of the rack.
- If the slides are not inserted correctly, the samples can become damaged in the subsequent processing.
- The stickers and/or labels used on the slides must be resistant to the solvents (xylene) used in the instrument.
- Labels that are used must not reach into the coverglass support area, and should not overhang over the edge of the slide, in order to avoid specimen impairment or instrument fault during coverslipping.
- Make sure that only one slide is put into each slot and that the slides are not jammed. There must not be empty slots between slides.

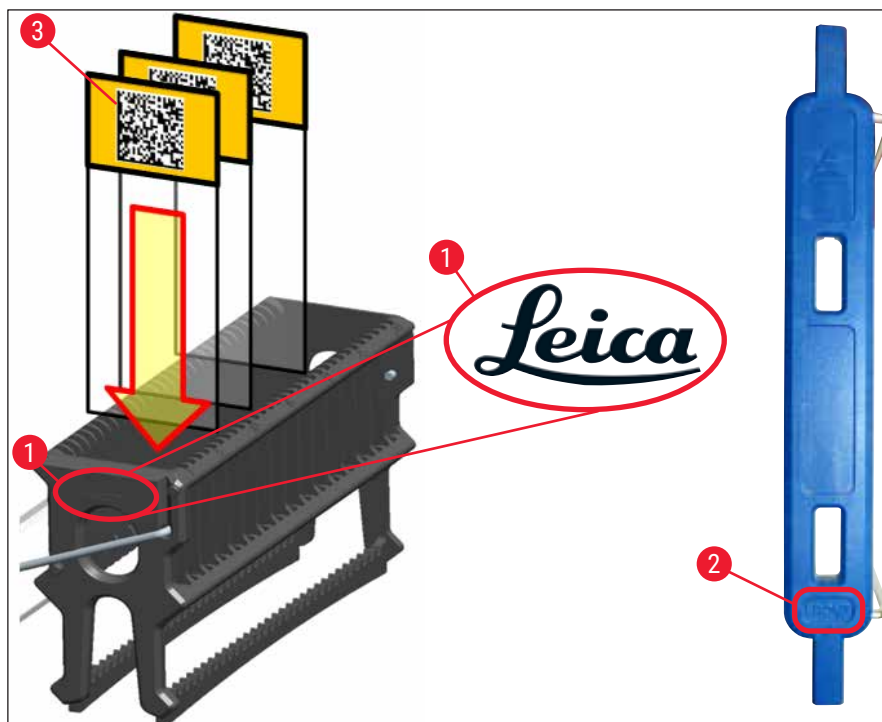

Fig. 70

**Note**

- When using printable labels or manual labels on the rack handles and the slides, they must be checked for solvent (xylene) resistance prior to use.

6.5 Brief inspection before starting the coverslipping operation

The following points have to be checked again before starting the coverslipping operation:

- Before starting the coverslipping operation, remove the covers of the reagent vessels in the load drawer and check the level. If necessary, refill xylene. The level should reach up to the label field on the slide for an inserted rack.
- When inserting the loaded rack, ensure that the slide receiving the coverslip has the side with the specimen pointing towards the user (instrument front).
- Furthermore, check and, if necessary, correct the following before starting the coverslipping operation:
 - Fill level of the mounting medium bottle (→ P. 79 – 6.3.1 Changing the mounting medium bottle) and of the coverglass cartridge (→ P. 83 – 6.3.3 Checking and replacing the coverglass cartridge).
 - Checking the proper mountant pump function (→ P. 122 – 7.3.1 Quick Prime).
 - Filling of the needle cleaning container (→ P. 82 – 6.3.2 Monitoring and refilling of the needle cleaning container).
 - Check for sufficient filling and correct position of the coverglass cartridge (→ P. 83 – 6.3.3 Checking and replacing the coverglass cartridge) and remove any dirt.
 - Empty the unload drawer (→ P. 89 – 6.3.7 Unload drawer) and check for dirt.
 - Check that the selected parameter set is capable of starting (→ P. 42 – 5.3 Process status display).
 - Check the skids, the suction cups and the coverglass sensor pins for dirt and broken glass (→ P. 87 – 6.3.5 Inspect Pick&Place module).
 - Check the waste tray for broken glass (→ P. 87 – 6.3.4 Emptying the waste tray).

6.5.1 Procedure of the coverslipping operation

- ① After an applicable rack has been inserted into the load drawer and the instrument is ready, the coverslipping operation begins.
 1. The reagent vessel (→ Fig. 71-1) with the rack is moved to the interior of the instrument to the rotator (→ Fig. 71-2).
 2. The gripper lifts the rack out of the reagent vessel and places it in the rotator (→ Fig. 71-2).
 3. The rotator brings the slide into the correct position.



Fig. 71

4. The gripper picks up the rack once again and places it in the elevator.
5. The elevator moves the rack into the position of the first slide.
6. The shifter transports the slide out of the rack to the coverslipping position with the shifter tongue.
7. During this movement, the needle applies the mounting medium to the slide.
8. At the same time, the Pick&Place module removes coverglass from the coverglass cartridge and transports it over the slide covered with mounting media and places the coverglass on the slide.
9. The lay-down movement provides for the uniform distribution of the mounting medium on the slide.
10. Afterwards, the shifter pushes the coverslipped slide back to its original position in the rack.
11. The elevator moves to the next slide, which the shifter transports to the coverslipping position.



Note

In order to prevent slides from drying out during processing, the first 5 slides are always coverslipped first. Then the rack moves upwards and continues coverslipping with the last slide in the rack (→ Fig. 74).

12. This sequence (steps 6 to 11) is repeated until all slides in the rack have been coverslipped.
13. When all slides are coverslipped, the elevator moves the rack downwards into the instrument.
14. The gripper removes the rack from the elevator and transports it into the oven to dry.
15. When the drying time period is complete, the rack is transported out of the oven and into the unload drawer by the gripper, and is put down in one of the three rear positions.
16. The user will be notified via an information message and can carefully remove the rack out of the unload drawer.

**Note**

If the oven step has been disabled or if the oven is completely shut down, the rack is transported – by the gripper – directly from the elevator into the unload drawer. Proceed carefully while removing out of the unload drawer, since the mounting medium is not yet completely dry and in the event of improper removal, coverglass may shift out of place.

6.6 Starting the coverslipping operation

**Note**

Once initialization is complete and the preparations have been made (→ P. 93 – 6.5 Brief inspection before starting the coverslipping operation) the coverslipping operation can be started by inserting a filled rack. It is important to make sure that the rack handle color matches the color of the parameter sets that is suitable for starting and being carried out.

**Warning**

- The rack can be inserted only using the load drawer. Accidentally inserting a rack into the unload drawer can lead to a collision and thus to an instrument fault and a possible loss of specimens!
- Direct insertion in the instrument is not possible!
- Exercise caution when opening or closing the drawers! Crushing hazard! The drawers are motorized and open or close automatically at the press of a button. Do not block the extension range of the drawers.

1. Fold the handle of the rack into the upright position (→ Fig. 68-2).
2. If the load drawer (→ Fig. 72-1) button is green, press it and open the drawer.
3. Insert the rack in an available position of the load drawer (→ Fig. 72-2).
4. Insert the rack so that both the **Leica** logo (→ Fig. 70-1) on the front side of the rack and the **Front** (→ Fig. 72-3) on the top of the colored handle are pointing toward the user. The arrow (→ Fig. 72-4) on top of the colored handle must point into the instrument.

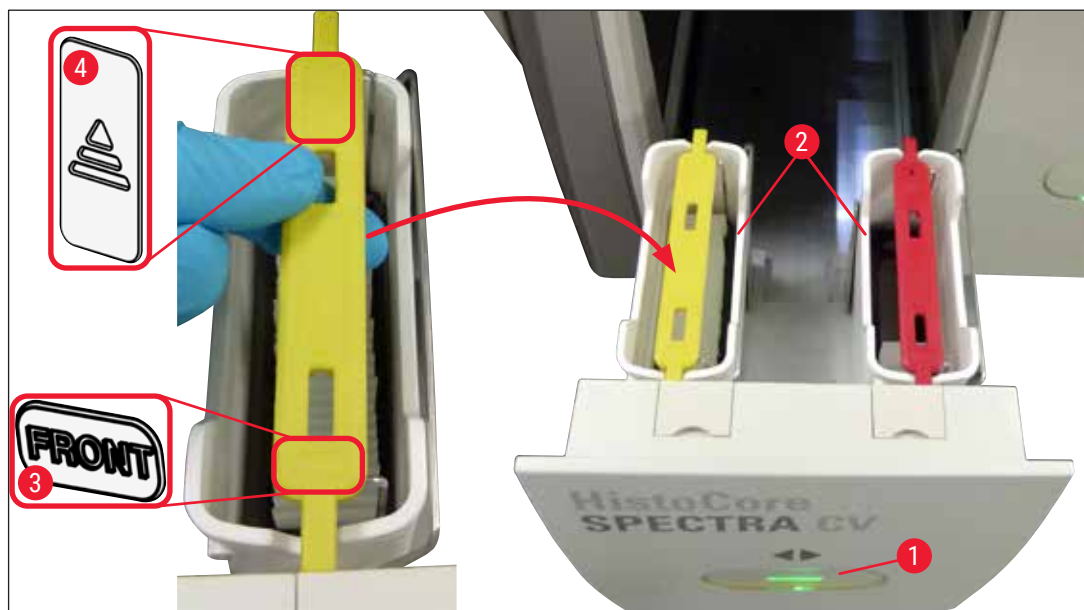

Fig. 72

5. Press the load drawer button again to close it again.
6. After closing the load drawer, the instrument detects the RFID chip in the colored handle.
7. The detected handle color is shown in the process status display (→ Fig. 73).

✓ Processing starts automatically.

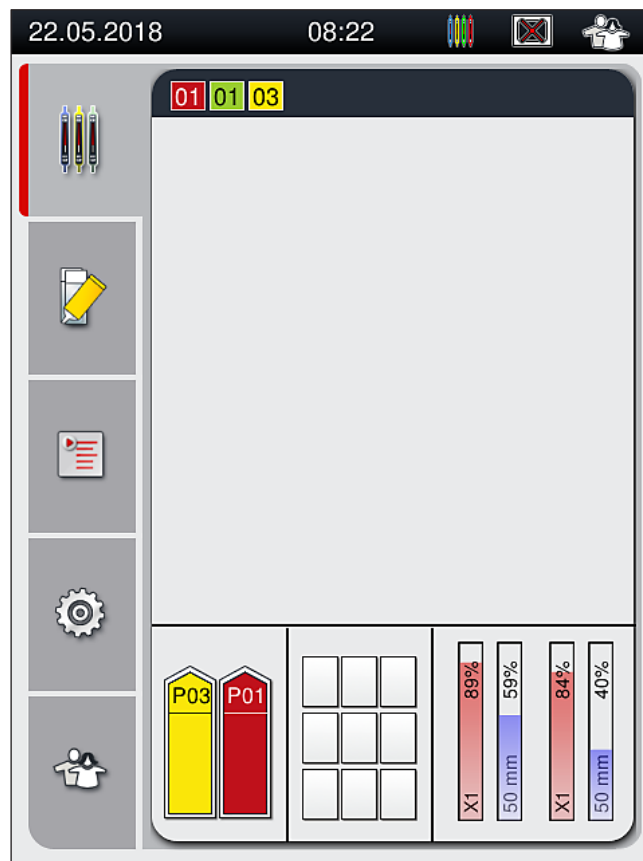

Fig. 73

**Note**

- The slides are not processed sequentially, i.e. they are not coverslipped in sequence.
- The schematic display (→ Fig. 74) of a rack (→ Fig. 74-1) with inserted slides (→ Fig. 74-2) shows the sequence during processing.
- The first five slides are coverslipped at the beginning (→ Fig. 74-3). Then the rack moves upwards and continues the coverslipping with the lowest slide (→ Fig. 74-4). The sixth slide (counted from above) is coverslipped last. This procedure prevents the lowest slide from drying out.
- Finished coverslipped slides are moved back to their original position within the rack.
- The instrument detects and indicates when a rack has been inserted in the wrong orientation and has to be corrected by the user.
- The system detects if a rack has been inserted into the load drawer with a rack handle color for which no parameter set is active, and the user is informed by a corresponding message. The rack must be removed from the instrument. Corresponding to the startable parameter sets (→ P. 42 – 5.3 Process status display), attach the correct colored handle to the rack and re-insert it into the load drawer.
- Racks that are inserted into the left-side reagent vessel in the load drawer are coverslipped in the **L1** coverslip line. Racks from the right-side vessel are coverslipped in the **L2** coverslip line.

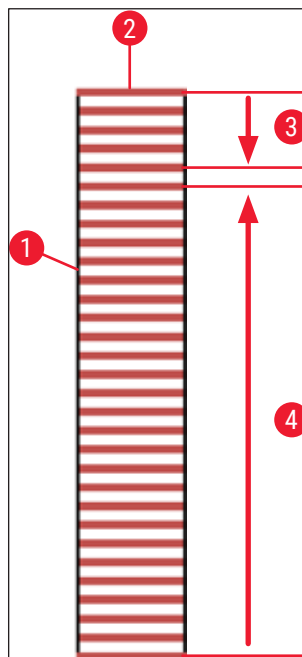

Fig. 74

6.6.1 Monitoring the coverslipping operation

The user can retrieve and monitor details regarding the ongoing coverslipping operations using the process status display (→ P. 42 – 5.3 Process status display):

- Process status display with calculated remaining coverslipping time, real time at the end of processing, coverslip line used, parameter set number (→ P. 42 – 5.3 Process status display).
- The status bar (→ P. 41 – 5.2 Elements of the status display) with the date, time, "process" icon, user status and icons indicating messages and warnings that occurred.
- The position of the rack is detected in the load and unload drawer using RFID.



Note

The last 20 active messages and warnings can be called up by touching the corresponding symbols in the status bar (→ Fig. 20-4) (→ Fig. 20-5). This allows the user to learn about past and current situations and to initiate any required actions.

6.6.2 Coverslipping operation finished

- If a rack ran the coverslipping operation, it will be transported in the unload drawer.
- The unload drawer can hold up to 9 racks. The racks are placed in the unload drawer in the sequence shown from A1 to C9 (→ Fig. 75).

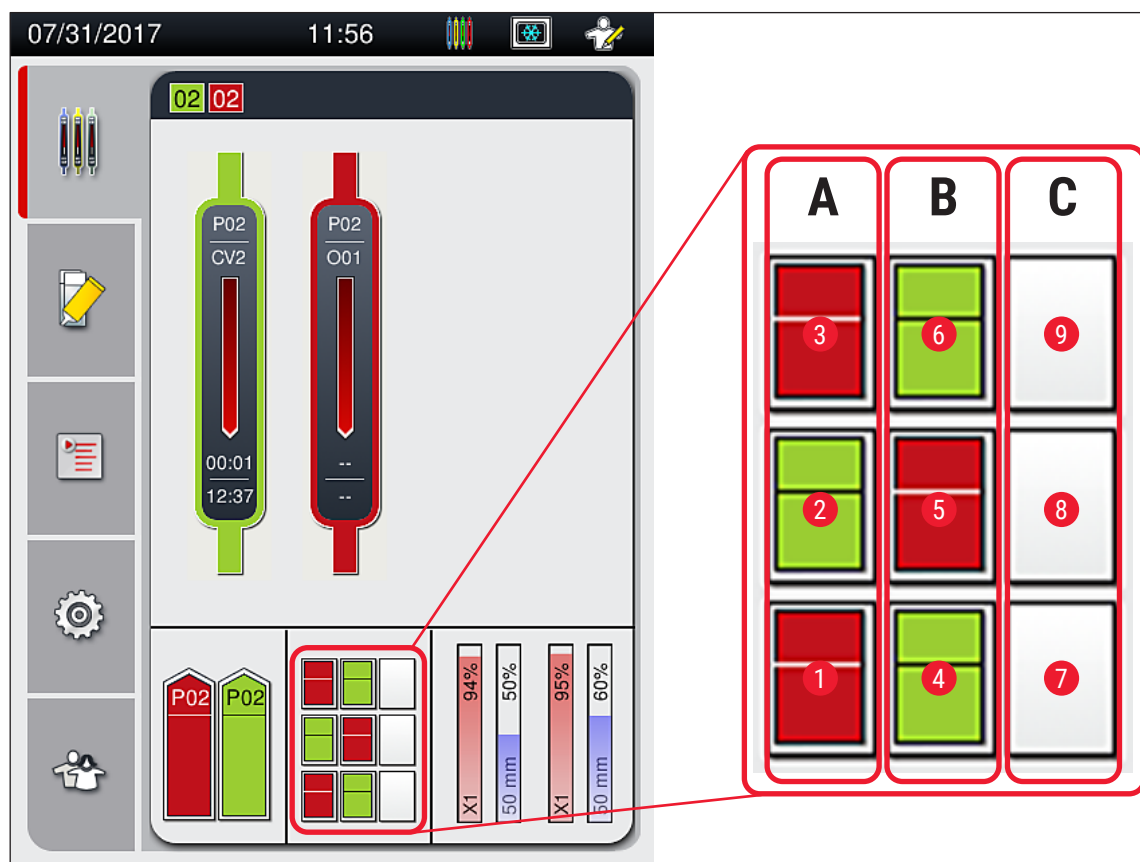

Fig. 75

Removing racks from the unload drawer

1. Press the button (→ Fig. 50-2) at the unload drawer to open and remove the rack.
2. Press the button again after removal to close the unload drawer.

✓ The status display for the unload drawer is updated after closing the drawer.



Note

- After the oven step has ended, the mounting medium is not completely dry. Treat the slides carefully during the removal from the rack to avoid a sliding of the coverglass.
- Ensure that all racks are always removed from the unload drawer.



Warning

- The unload drawer must be opened and all racks present must be removed – at the latest – when the message is received indicating that the unload drawer is completely occupied (→ Fig. 76). Failure to observe the message may lead to instrument faults and specimen impairment.
- Finished coverslipped racks remain in the oven until all racks are removed from the unload drawer. The longer dwell time in the oven can lead to specimen impairments.
- If not all racks are removed from the unload drawer, this can lead to sample destruction.
- To ensure a smooth operation of the instrument software, the instrument must be restarted by the user at least every 3 days. This applies to both HistoCore SPECTRA ST and HistoCore SPECTRA CV stand-alone units as well as in operation as a workstation. This also implies the HistoCore SPECTRA CV must be restarted by the user at least every 3 days.

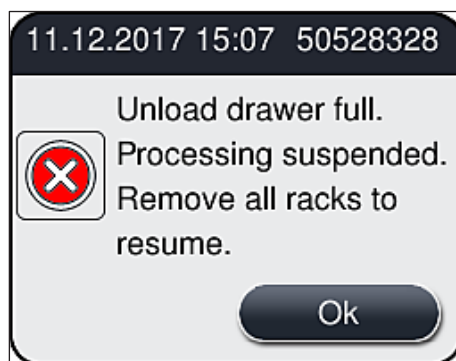

Fig. 76

- The user receives an information message (→ Fig. 77) if the unload drawer is open for longer than 60 seconds.

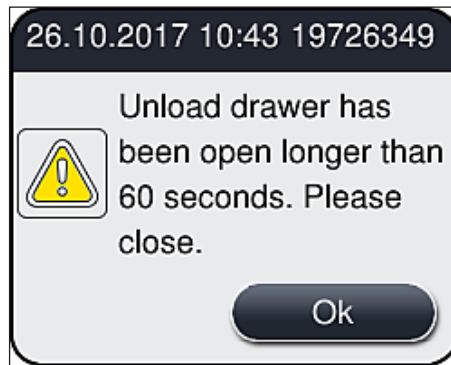

Fig. 77

**Note**

The warning message prompts the user to close the unload drawer in order to prevent possible delays in processing. When the unload drawer is open, the instrument cannot place completely coverslipped racks into the unload drawer.

- The message goes away as soon as the unload drawer is closed.

6.6.3 Pausing or canceling the coverslipping operation

Pausing the coverslipping operation

**Note**

Opening the hood automatically pauses any coverslipping operations in progress, during which coverslipping for the most recently processed slide is completed. Closing the hood allows the coverslipping operations to continue.

**Warning**

Specimens that have not yet received a coverslip are unprotected at this point (risk of drying out)! Therefore the hood should only be opened in an emergency during the coverslipping operation (→ P. 131 – 8. Malfunctions and Troubleshooting).

Canceling the coverslipping operation

- ① Coverslipping operations can only be canceled using the process status display (→ Fig. 78).

1. To cancel a coverslipping operation, select the corresponding rack (→ Fig. 78-1) by touching it.

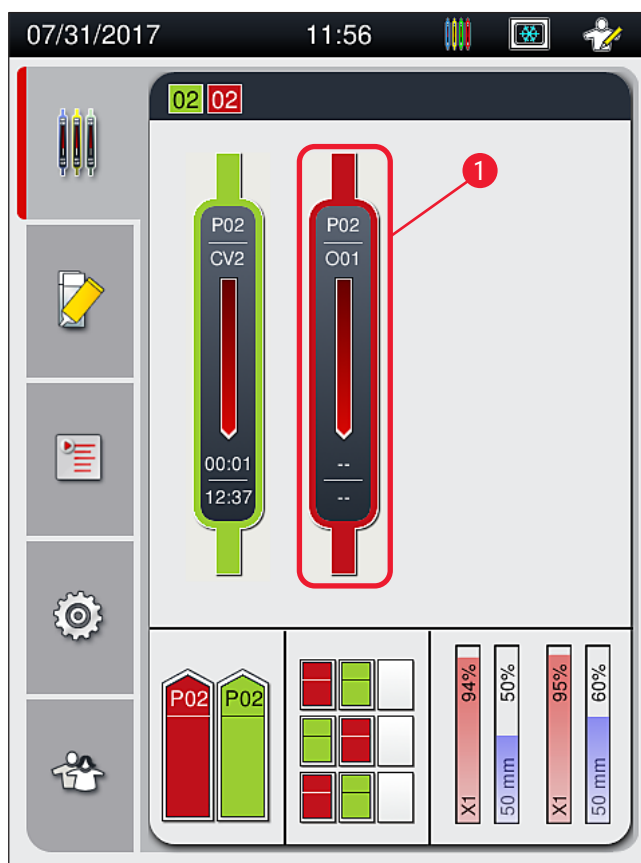

Fig. 78

2. An overview appears of the rack for which the process is being canceled (→ Fig. 79).
3. The border of the window shows the color assigned to the parameter set, the mounting medium used, the coverslip size used and the stored volume.
4. Press the **Abort Rack** (→ Fig. 79-1) button or the **Close** (→ Fig. 79-2) button in order to continue processing for the selected rack.

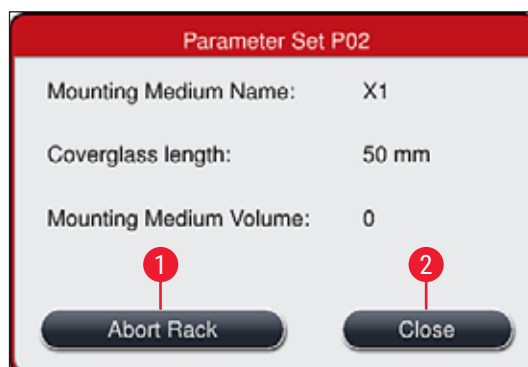

Fig. 79

After pressing the **Abort Rack** (→ Fig. 79-1) button, an information message is displayed (→ Fig. 80). Confirm the cancellation with the button **Yes** (→ Fig. 80-1) or press **No** (→ Fig. 80-2) to return to the process status display (→ Fig. 78).

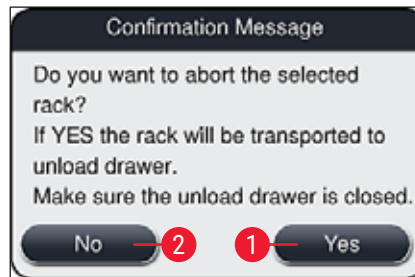

Fig. 80



Note

After confirming the cancellation, the rack is transported into the unload drawer and can be removed there.

6.7 Workstation operation

6.7.1 Notes on workstation mode



Warning

The user must adhere to the following in workstation operation!

- The last stations of the HistoCore SPECTRA ST must be filled with the same reagent (xylene) as the reagent vessels in the load drawer of the HistoCore SPECTRA CV in order to prevent compatibility problems with the mounting medium being used and to prevent drying out the specimens (→ P. 131 – 8.1 Troubleshooting).
- As a last step, the transfer station is to be indicated in the staining program of the HistoCore SPECTRA ST so that finished stained racks can be transferred to the HistoCore SPECTRA CV. The description on the correct generation of staining programs can be found in the Instructions for Use of the HistoCore SPECTRA ST.
- Using reagents that are incompatible with each other can lead to substantial impairments in specimen and coverslipping quality.
- If the HistoCore SPECTRA CV cannot accept a rack from the HistoCore SPECTRA ST (e.g. due to an instrument fault in the HistoCore SPECTRA CV or if the load drawer of the HistoCore SPECTRA CV is assigned), these will be transported to the HistoCore SPECTRA ST unload drawer.
- Therefore, the reagent vessels in the output drawer of the HistoCore SPECTRA ST as well as the reagent vessels in the input drawer of the HistoCore SPECTRA CV must be filled with xylene to prevent the tissue samples from drying out.
- If a longer power failure occurs, proceed as described in (→ P. 136 – 8.2 Power failure scenario and instrument failure).
- Note that in workstation mode, the HistoCore SPECTRA CV cannot process any racks for 5 slides.
- The instrument detects the manual insertion of racks for 5 slides in the load drawer of HistoCore SPECTRA CV. An information message prompts the user to remove this rack again from the load drawer.

**Warning**

- If racks for 5 slides are used for staining in the HistoCore SPECTRA ST, select the unloader as the last step in the program. Remove the finished stained slides and place them into a suitable rack for the HistoCore SPECTRA CV.

**Note**

- The HistoCore SPECTRA CV can be operated as a workstation together with HistoCore SPECTRA ST. This allows an uninterrupted workflow from inserting into the stainer up to removing the completely stained and coverslipped slides from the coverslipper.
- In workstation mode, the racks in the HistoCore SPECTRA ST can either be passed directly to the unload drawer or directly to the HistoCore SPECTRA CV by means of the transfer station and placed into a reagent vessel for the load drawer of the HistoCore SPECTRA CV. In the Instructions for Use for the HistoCore SPECTRA ST, the notes on program creation must be observed.
- The time of transfer of the finished and colored rack to the HistoCore SPECTRA CV is then separately displayed in the process status display of the HistoCore SPECTRA ST (→ Fig. 81-5).
- After completion of the coverslipping operation, the racks are placed in the unload drawer of the HistoCore SPECTRA CV.
- If the racks from HistoCore SPECTRA ST are being transferred to the HistoCore SPECTRA CV, the load drawer of the HistoCore SPECTRA CV is blocked during this time period and racks cannot be inserted into the HistoCore SPECTRA CV manually.
- The brief inspection before the daily startup (→ P. 93 – 6.5 Brief inspection before starting the coverslipping operation) must be carried out.
- If the network connection between HistoCore SPECTRA ST and HistoCore SPECTRA CV is interrupted or HistoCore SPECTRA ST is shut down, the HistoCore SPECTRA CV can only be used as a standalone instrument. Workstation mode is no longer possible in that case. Only manual loading using the load drawer is still possible then.
- Both instruments have to be taken out of service separately using their own **Operating switch** after operation.
- In order to ensure operation free of interruptions, always leave both instruments switched on and follow the notes on daily startup (e.g. refilling consumables, removing the cover from the reagent vessels in the load drawer of the HistoCore SPECTRA CV).
- Resolve any faults immediately if the HistoCore SPECTRA CV has been stopped. Otherwise, altered staining results can occur in the HistoCore SPECTRA ST because racks where staining has been completed can no longer be transferred to the HistoCore SPECTRA CV, creating potential for a backlog.
- Stay within earshot of the instruments so that you can respond to the audible signals immediately.
- In workstation mode it is also possible to place a rack for coverslipping directly in the load drawer of the HistoCore SPECTRA CV. In doing so, however, the user must ensure that this rack, placed by hand, is detected by the instrument (→ P. 42 – 5.3 Process status display).

6 Daily Instrument Setup

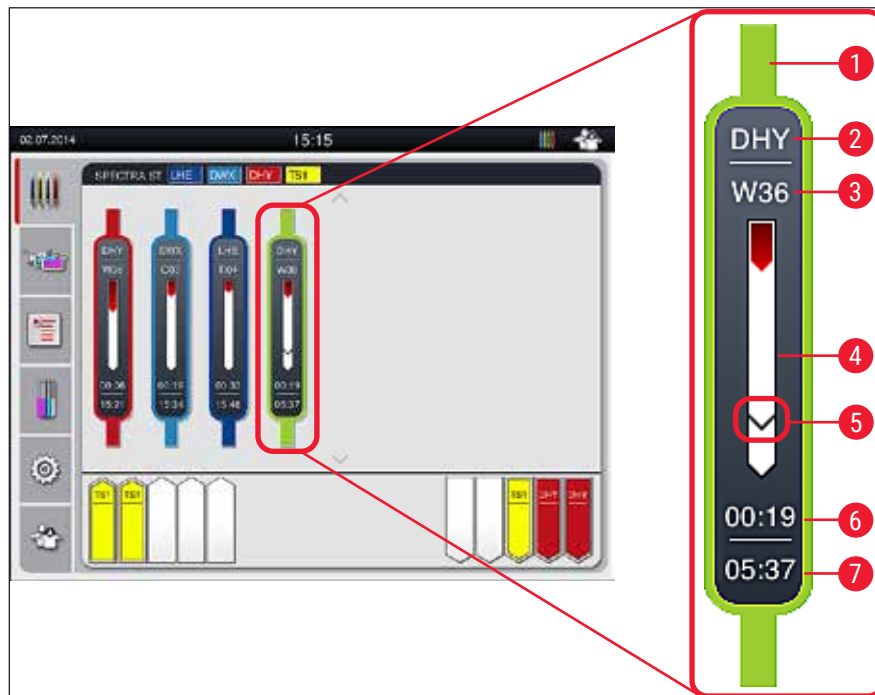

Fig. 81

- 1 Program color
- 2 Abbreviation of the program name
- 3 Current position of the rack in the instrument
- 4 Progress display of the entire staining process
- 5 Time of transfer to the connected HistoCore SPECTRA CV
- 6 Estimated remaining time (hh:mm)
- 7 Time at end of process

On the HistoCore SPECTRA ST status display, a symbol indicates whether there is a connection to a HistoCore SPECTRA CV or if the connection has been interrupted.



The connection between the HistoCore SPECTRA ST and the HistoCore SPECTRA CV has been established.



The connection between the HistoCore SPECTRA ST and the HistoCore SPECTRA CV has been interrupted.

6.7.2 Starting the coverslipping operation in workstation mode

- ① The coverslipping operation also starts automatically just like after manually inserting a rack in the load drawer.
 1. Place the rack into the load drawer of the HistoCore SPECTRA ST.
 2. Both the staining and coverslipping processes are controlled by the assigned rack handle color.
 3. Racks where the staining and coverslipping processes have been completed are automatically placed in the unload drawer of the HistoCore SPECTRA CV and have to be removed by the user there.
- ① As soon as a rack is placed in the HistoCore SPECTRA ST that has to be transferred through the **transfer station** to the HistoCore SPECTRA CV, the **process** icon is displayed on the status bar (→ Fig. 20-7) of the HistoCore SPECTRA CV.



The **Process** symbol indicates that processing is currently active and that a rack may still be in the unload drawer or a rack from the HistoCore SPECTRA ST is expected.



Note

In workstation mode it is also possible to place a rack for coverslipping directly in the load drawer of the HistoCore SPECTRA CV.

7. Cleaning and Maintenance

7.1 Important notes about cleaning this instrument



Warning

- The instrument should always be cleaned after the end of work, but **BEFORE** the instrument is shut down. An exception from this is cleaning the interior (→ P. 108 – 7.2.4 Interior cleaning). We recommend cleaning while the instrument is shut down.
- The regular maintenance intervals must be observed.
- When using cleaners, please comply with the safety instructions of the manufacturer and the laboratory safety regulations.
- Proceed carefully and wear suitable protective clothing when cleaning the instrument (lab coat, cut-resistant gloves and safety goggles).
- Never use solvents (such as alcohol, acetone, xylene, toluene etc.) or cleaning agents containing solvents to clean the exterior of the instrument.
- Prevent liquids from entering the interior of the instrument or electrical contacts while the instrument is being cleaned or during operation.
- Solvent vapors can develop if solvents are left in the instrument after shutting it down. There is a risk of fire or poisoning if the instrument is not operated under a fume hood!
- Dispose of used reagents while observing applicable local regulations and the disposal regulations of your company/lab.
- Shutting down the instrument for longer breaks in work and switch it off at the end of the workday (→ P. 77 – 6.2 Switching on and shutting down the instrument).
- Immediately use a lint-free cloth to wipe off mounting medium that drips onto/into the instrument (e.g. during priming or exchanging a mounting medium bottle).
- Make sure that significant amounts of solvent are not spilled in the instrument (danger for the electronics!). If solvent has been spilled, immediately remove the liquid with an absorbent cloth.
- To prevent damage, never leave plastic accessories immersed in solvent or water for a prolonged time (e.g. overnight).
- Never clean plastic reagent vessels at temperatures higher than 65 °C since this can deform reagent vessels!

7.2 Description of cleaning individual instrument components and areas

7.2.1 Exterior surfaces, varnished surfaces, instrument hood

- » The surfaces (hood and housing) can be cleaned with a mild, pH-neutral, commercially available cleaning agent. After cleaning the surfaces, wipe them off with a cloth moistened with water.



Warning

Varnished instrument surfaces and plastic surfaces (e.g. an instrument hood) may not be cleaned with solvents like acetone, xylene, toluene, xylene substitutes, alcohol, alcohol mixtures and abrasives! In case of long-term exposure, the surfaces and instrument hood are only conditionally resistant to solvents.

7.2.2 TFT touchscreen

- » Clean the screen using a lint-free cloth. A suitable screen cleaner can be used in compliance with the manufacturer information.

7.2.3 Load and unload drawers



Warning

- To avoid an overflowing of a filled reagents, do not open the load drawer suddenly.
- Wear suitable protective clothing (lab coat, safety goggles, cut-resistant gloves).

1. Remove reagent vessels (→ Fig. 82-1) from the load drawer and store them outside the instrument.
 2. Check the xylene in the reagent vessels, correct the level or replace the xylene if necessary (→ P. 32 – 4.6 Refilling consumables).
 3. Check the inside of the load drawer for reagent residue and clean up any you find (→ P. 108 – 7.2.4 Interior cleaning).
 4. Finally, insert the reagent vessels into the correct positions again.
- ① Observe the existing labeling (→ Fig. 82-2) for stations in the drawers.

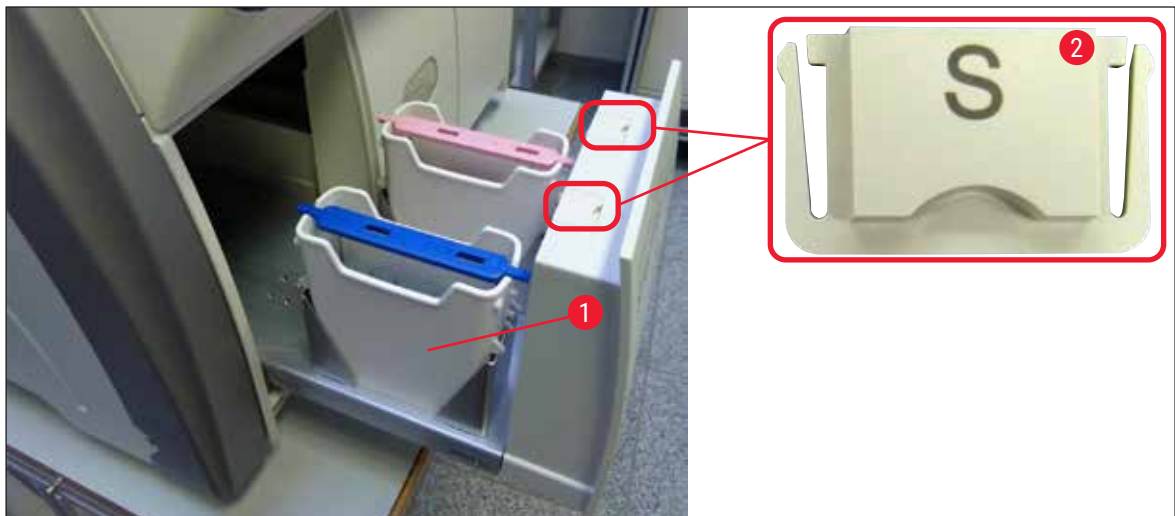

Fig. 82



Note

Reagent residue can also be present in the unload drawer from transporting the racks from the coverslip line to the oven. Therefore, check the inside of the unload drawer for reagent residue and clean if necessary (→ P. 108 – 7.2.4 Interior cleaning).

7.2.4 Interior cleaning



Warning

- There is a danger of cutting injuries during this cleaning step. Therefore, proceed with the necessary caution and wear cut-resistant gloves (→ P. 18 – 3.1 Standard delivery – packing list)!
- The warning messages in (→ P. 32 – 4.6 Refilling consumables) must be observed when handling solvents!

1. Open the load and unload drawers and check the interior space behind the drawers for broken glass and residual mountant.



Note

Remove all existing racks in the load and unload drawers before cleaning (→ Fig. 83).



Fig. 83

2. Carefully remove any dirt remnants.
3. Pull the retaining lever for the unload drawer (→ Fig. 84-1) upwards while slowly continuing to open the drawer as far as it will move.

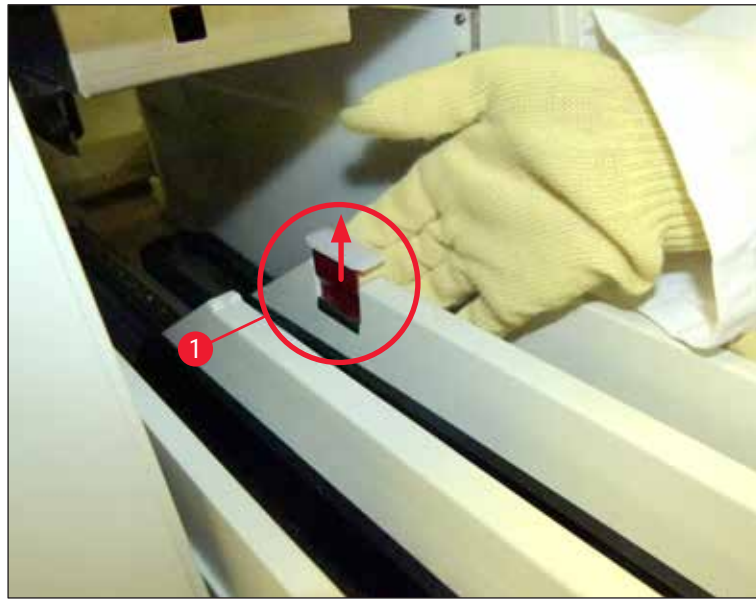

Fig. 84

4. Carefully fold the unload drawer down and support it with one hand to allow you to clean the rear area inside the instrument (→ Fig. 85).



Fig. 85

5. Soak a lint-free cloth with xylene and remove any mounting medium residue that may be present. You can use a commercially available vacuum cleaner to pick up any non-adhesive glass shards, splinters or dust.
6. Finally bring the unload drawer back in its horizontal position and move it in the instrument.

7.2.5 Cleaning the prime bottle

- » Check the prime bottle for dried-out residual mountant and clean it with xylene if necessary. To prevent delays, keep a replacement prime bottle ready and insert it into the position provided for it in the instrument.

7.2.6 Cleaning the cannulas for the mounting medium bottle

- » While changing a mounting medium bottle, check the cannula for dried mounting medium residue and contamination and, if necessary, moisten with xylene and clean with a lint-free cloth.



Note

There is a filter inserted in the cannula that prevents contamination from getting inside the internal hose system. This filter is replaced every two years by a Leica service technician as part of annual maintenance.

7.2.7 Cleaning the needle

1. Select the **Module Status** (→ P. 74 – 5.11 Module status) menu in the main menu and press the **Prime/Clean** button in the desired coverslip line.
2. The needle moves automatically to the maintenance position.
3. If the needle is heavily soiled (→ Fig. 86-1), remove it laterally from its holder (→ Fig. 86-2) and hook it into a container filled with xylene. Let it soak shortly (approx. 10 min.).

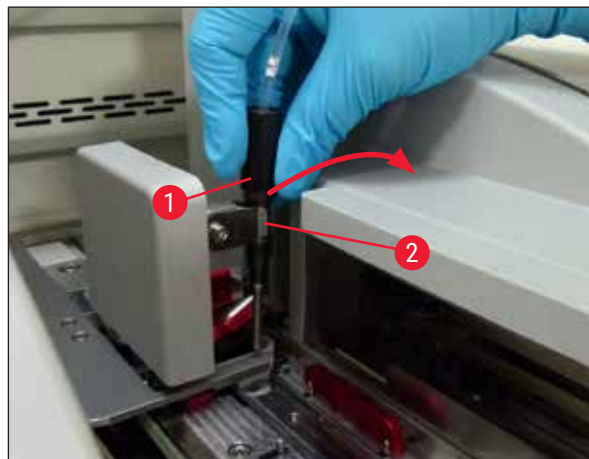

Fig. 86

4. Then remove the needle from the xylene, moisten it with xylene and wipe off the residual mountant with a soft, lint-free cloth.
5. Finally, insert the needle (→ Fig. 87-1) back into its holder (→ Fig. 87-2).

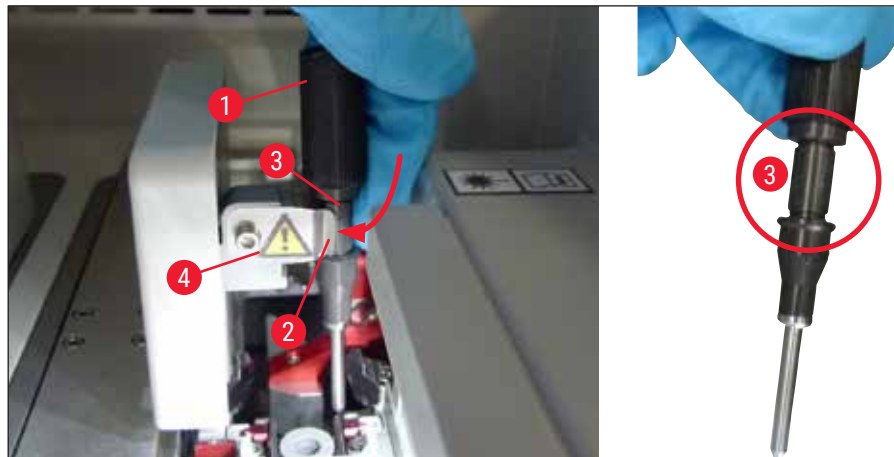

Fig. 87

**Note**

The needle has a notch (→ Fig. 87-3) that fits exactly in the holder. The Attention symbol (→ Fig. 87-4) on the holder (→ Fig. 87-2) indicates to the user that utmost care is required when inserting the needle into the holder. The needle must be inserted straight and all the way in order to make sure that no negative impact on the samples arises during processing.

Replace**Warning**

- Only a Leica service technician may exchange a needle unit.
- An exchange of only the needle is not possible.

7.2.8 Cleaning the shifter

Check the shifter (→ Fig. 88-1), the alignment pins (→ Fig. 88-2) and the coverslipping line (→ Fig. 88-3) for any mounting medium residues. Use a lint-free cloth moistened with xylene to remove adhering mounting medium.

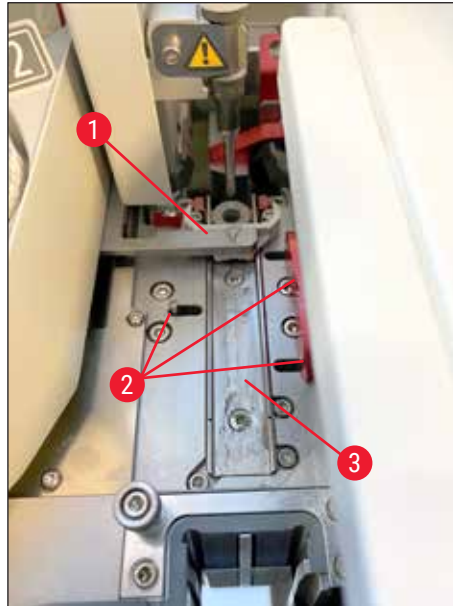

Fig. 88

7.2.9 Filling and changing the needle cleaning container

- For handling the needle cleaning container, see (→ P. 82 – 6.3.2 Monitoring and refilling of the needle cleaning container).
- To clean the glass cylinder (without cap), immerse it in xylene overnight to dissolve the residual mountant.



Note

Replacement of a needle cleaning container:

- Needle cleaning containers can be ordered (→ P. 153 – 9.1 Optional accessories) and be replaced. We recommend always having a spare vessel ready so that the vessel in use can be regularly cleaned with xylene and routine operation can continue with the spare vessel.

7.2.10 Removing the complete unit of the needle cleaning container

The needle cleaning container is inserted into a red complete unit (→ Fig. 89-1), which can be removed by the user through the opening in the unload drawer. The complete unit is hooked into the coverslip line by two lateral pins (→ Fig. 89-3). The removal may be necessary if the needle cleaning container (→ Fig. 89-2) is stuck due to dried mounting medium and cannot be removed as described (→ P. 82 – 6.3.2 Monitoring and refilling of the needle cleaning container).



Fig. 89

**Warning**

- There is a danger of cutting injuries when removing the complete unit. Therefore, proceed with the necessary level of caution and wear cut-resistant gloves (→ P. 18 – 3.1 Standard delivery – packing list).
- The warning messages in (→ P. 32 – 4.6 Refilling consumables) must be observed when handling solvents!

1. Open the hood.
2. Call up the **Module Status** and press the **Prime/Clean** button of the respective **L1** or **L2** coverslip line.
3. The needle moves upwards out of the needle cleaning container.
4. Remove the needle from the holder and insert it into the prime bottle.
5. Open the load and unload drawers completely and remove all racks.

**Note**

The unload drawer is capable of being unlocked and folded down so the user has easier access to the interior of the instrument (→ P. 108 – 7.2.4 Interior cleaning). In doing so, make sure that the inserts do not fall out into the unload drawer.

6. Carefully reach into the interior of the instrument through the opening of the unload drawer and feel around the complete unit for the needle cleaning container (→ Fig. 90-1).
7. Grasp the complete unit from below and tilt it slightly in the direction of the back panel (→ Fig. 90-2).

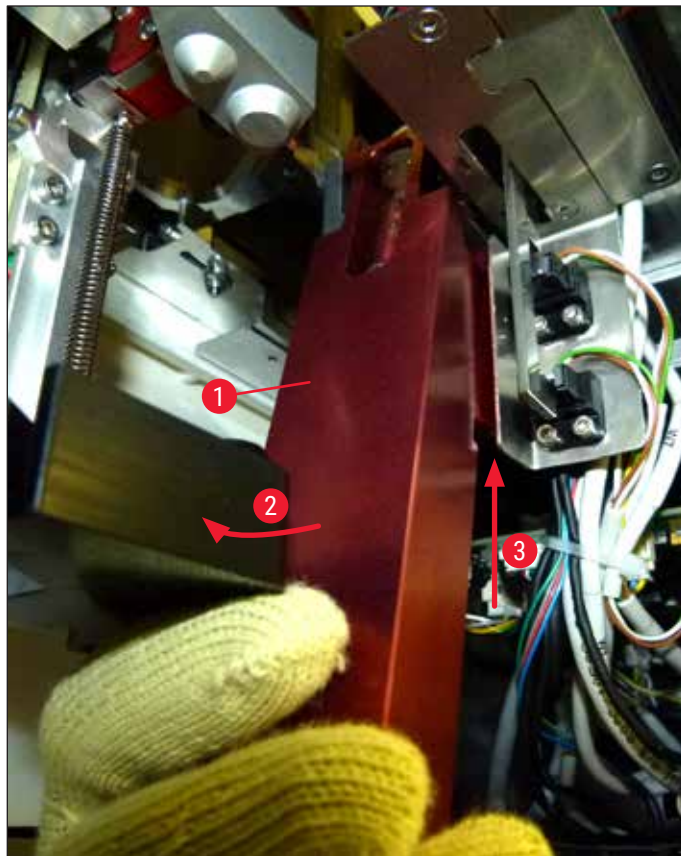

Fig. 90

8. Then lift the complete unit (→ Fig. 90-3) so that the pins (→ Fig. 91-1) are lifted back over the notches (→ Fig. 91-2).

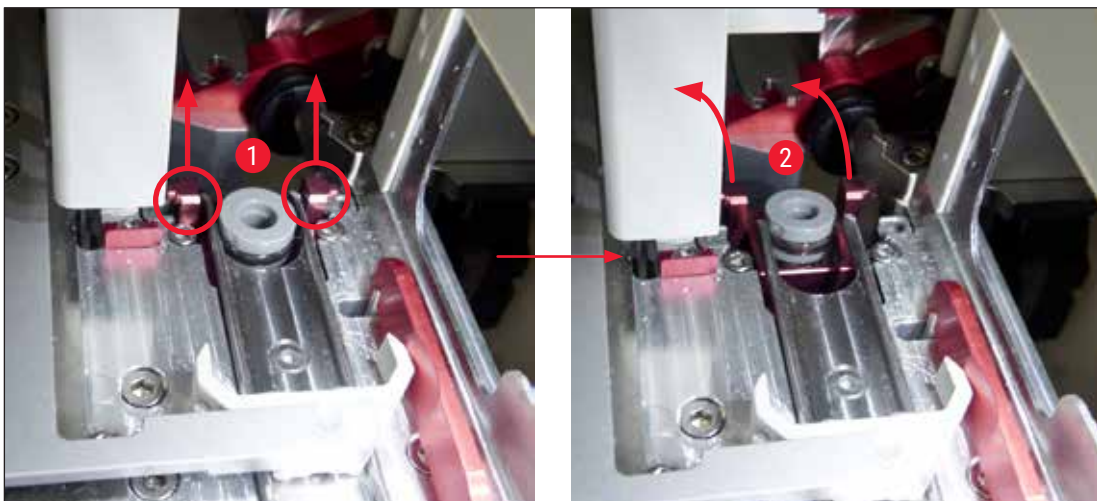

Fig. 91

9. In the next step, guide the complete unit back and down and carefully remove it through the opening in the unload drawer.

**Warning**

Remove the complete unit through the slot in the unload drawer, keeping it as upright as possible to prevent xylene from running out of the needle cleaning container.

10. Position the complete unit with the attached needle cleaning container upside-down in a container of sufficient size with xylene. Allow the xylene to take effect for approximately 10 minutes.

11. Then take the complete unit out of the xylene bath and let it drip off. Removing the needle cleaning container should now be easy.

**Warning**

- The needle cleaning container is very fragile. If the needle cleaning container cannot be removed after the xylene bath, the recommended course of action is to immerse the complete unit with the container in xylene for a long period.
- In the meantime, insert the needle into a container with xylene to prevent the needle from drying out.
- Please note that the coverslip line from which the complete unit was taken cannot be used during this time.

12. Wipe the complete unit, glass cylinder and cap with a lint-free cloth that has been moistened with xylene and dry.

13. Carefully insert the complete unit, without needle cleaning container, back into the correct position inside the instrument.

14. Fill the needle cleaning container with solution while it is outside the instrument (→ P. 82 – 6.3.2 Monitoring and refilling of the needle cleaning container) and insert it into the complete unit.

15. Insert the needle from the prime bottle back into the needle holder and press the **Close** button in the **Prime/Clean** menu.

16. Finally, close the hood.

7.2.11 Cleaning the Pick&Place module

- For handling the Pick&Place module, see (→ P. 87 – 6.3.5 Inspect Pick&Place module).

Clean the following areas of the Pick&Place module with a lint-free cloth soaked with xylene:

1. Check the front and rear suction cups (→ Fig. 92-2) at the Pick&Place module for dirt and damages. Remove dirt with a lint-free cloth and a cloth soaked in xylene. Deformed or damaged suction cups must be replaced (→ P. 116 – 7.2.12 Exchange suction cups).
2. Carefully clean the skids (→ Fig. 92-1) on the left and right on the Pick&Place module from dirt.
3. Control the coverglass sensor pin (→ Fig. 92-3) for glued-on materials and mobility.

- ⓘ Dispose of glass shards, splinters and dust in accordance with laboratory specifications.



Note

At the bottom of the Pick&Place module is the coverglass sensor pin between both suction cups (→ Fig. 92-3). The coverglass sensor pin can be moved freely if you can move it up and down by touching it lightly with your fingertip.

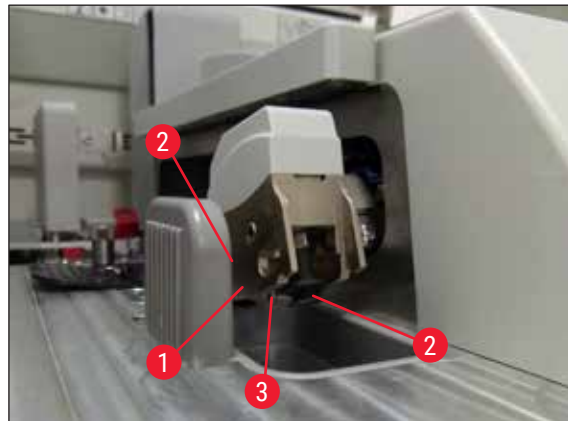

Fig. 92

7.2.12 Exchange suction cups

1. Unplug the deformed and/or dirty suction cups from the Pick&Place module and dispose in accordance with laboratory regulations.
2. Remove new suction cups from the package.
3. Attach the suction cups at the front (→ Fig. 93-2) and rear (→ Fig. 93-3) of the Pick&Place module using a bent tweezers (→ Fig. 93-1).



Note

- Carefully attach the suction cups with a bent tweezers to avoid damage to the new suction cups.
- Make sure that the suction cups fit correctly. Coverglass cannot be picked up if the suction cups are fastened incorrectly.
- We recommend having a rack filled with empty slides coverslipped for a function check.

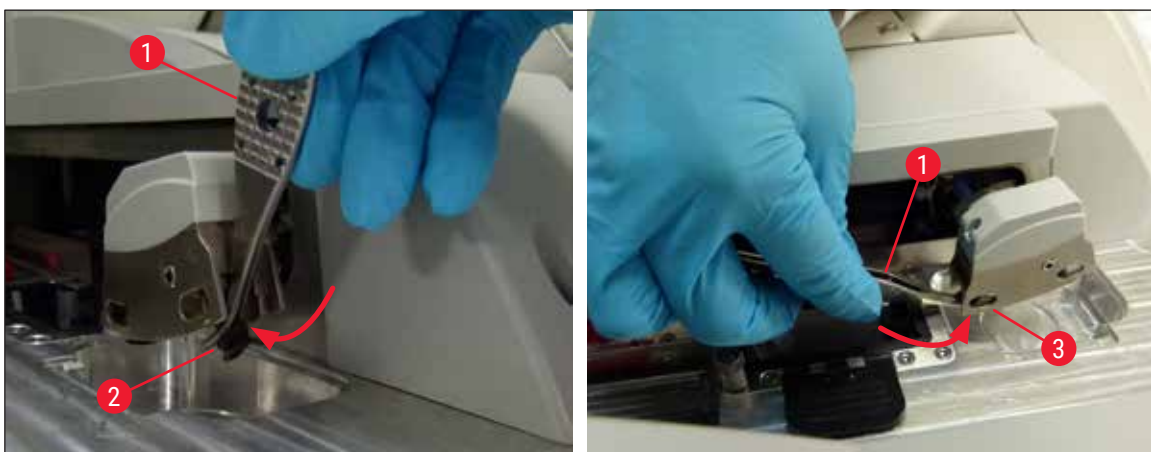

Fig. 93

7.2.13 Cleaning the waste tray



Warning

Wear cut-resistant safety gloves (→ P. 18 – 3.1 Standard delivery – packing list) for emptying the waste tray!

For handling, removing and re-inserting the waste tray, see (→ P. 87 – 6.3.4 Emptying the waste tray).

- » Soak a lint-free cloth with xylene and remove any mounting medium residue that may be present.



Note

Dispose of glass shards, splinters and dust in accordance with laboratory specifications.

7.2.14 Cleaning the reagent vessels

1. Remove the reagent vessels individually from the load drawer by the handle. Ensure that the handle is in the correct position (→ P. 37 – 4.6.3 Prepare the reagent vessel, fill it and insert it into the load drawer) to prevent spilling the reagent.
2. Dispose of filled reagents in accordance with the local laboratory specifications.
3. All reagent vessels can be cleaned in a dishwasher at a maximum temperature of 65 °C using a standard, commercially available detergent for lab dishwashers. The handles can remain attached to the various vessels when doing so.



Warning

- Reagent vessels are to be pre-cleaned manually before cleaning in a dishwasher. Any staining residue that may be present is to be removed to the greatest extent possible to prevent discoloration of the remaining reagent vessels in the dishwasher.
- Never clean plastic reagent vessels at temperatures higher than 65 °C since this can deform reagent vessels!

7.2.15 Rack and handle

- ① The racks are to be checked regularly for mounting medium residue and other possible contamination.
 1. The colored handle must be removed from the rack for cleaning.
 2. To remove small amounts of residual mountant, soak a lint-free cloth with xylene and clean the racks.
 3. For stubborn dirt, you can place the racks in a xylene bath for up to 1–2 hours to remove dried out residual mountant.
 4. The xylene can then be washed off with alcohol.
- ✓ Completely rinse the racks with clean water and then dry them.
- ① A dishwasher can also be used for the cleaning process. The maximum temperature of 65 °C must be observed.

**Note**

The maximum exposure time in a xylene bath is 1–2 hours. Completely rinse the racks with water, then dry them. If an external oven is used for drying, the temperature must not exceed 70 °C.

**Warning**

- The racks and handles may not remain in the xylene for a long time frame (e.g. several hours or overnight), because this can lead to deformation!

7.2.16 Changing the active carbon filter**Note**

The active carbon filter installed in the instrument helps reduce the amount of reagent vapors in the exhaust air. The life cycle of the filter can fluctuate strongly depending on intensity of use and the reagent configuration of the instrument. Therefore, replace the active carbon filter regularly, but at least every three months, and dispose of it properly in accordance with the laboratory regulations applicable in the country of use.

1. The user can access the activated carbon filter (→ Fig. 94-1) from the front of the instrument by opening the upper cover (→ Fig. 94-2).
2. The activated carbon filter can be accessed without any tools and can be removed by pulling on the pull tab.
3. Write the insertion date on the white adhesive label on the front side of the activated carbon filter (→ Fig. 94-3).
4. Insert the new activated carbon filter in such a way that the pull tab is visible and reachable even after it is completely pushed in.
5. The active carbon filter must be pushed in until you feel it make contact with the rear panel of the instrument.
6. Close the cover (→ Fig. 94-2) again.



Fig. 94

7.2.17 Cleaning reagent vessels in the load drawer

- Open the load drawer and individually remove the reagent vessels by the handle. Ensure that the handle is in the correct position (→ P. 37 – 4.6.3 Prepare the reagent vessel, fill it and insert it into the load drawer) to prevent spilling the reagent.
- Dispose of reagents in accordance with the local laboratory specifications.
- All reagent vessels can be cleaned in a dishwasher at a maximum temperature of 65 °C using a standard, commercially available detergent for lab dishwashers. The handles can remain attached to the reagent vessels during this process.



Warning

- Never clean reagent vessels at temperatures higher than 65 °C since this can deform reagent vessels!

7.3 Preparing the hose system for priming and cleaning



Note

- The user must flush the hose system during daily instrument setup and when inserting a new mounting medium bottle. This ensures that the needle is not blocked and the internal hose system is free of air bubbles.
- During a scheduled, prolonged break in instrument use (more than 5 days), the user must carry out a complete cleaning of the hose system (→ P. 124 – 7.3.3 Cleaning the hose system) to prevent damage to the system.
- The processing in the second line is also interrupted during the priming process or during the cleaning process. slides could dry out on that line. For this reason, Leica recommends priming or cleaning only if all racks have been removed from the instrument and with the instrument in idle mode.

Priming preparation

1. To get to the menu, press the **Module Status** (→ Fig. 95-1) button in the main menu.
2. Following this, press the **Prime/Clean** button of the respective left (→ Fig. 95-2) or right (→ Fig. 95-3) coverslip line and acknowledge the warning message with **Ok** (→ Fig. 96).

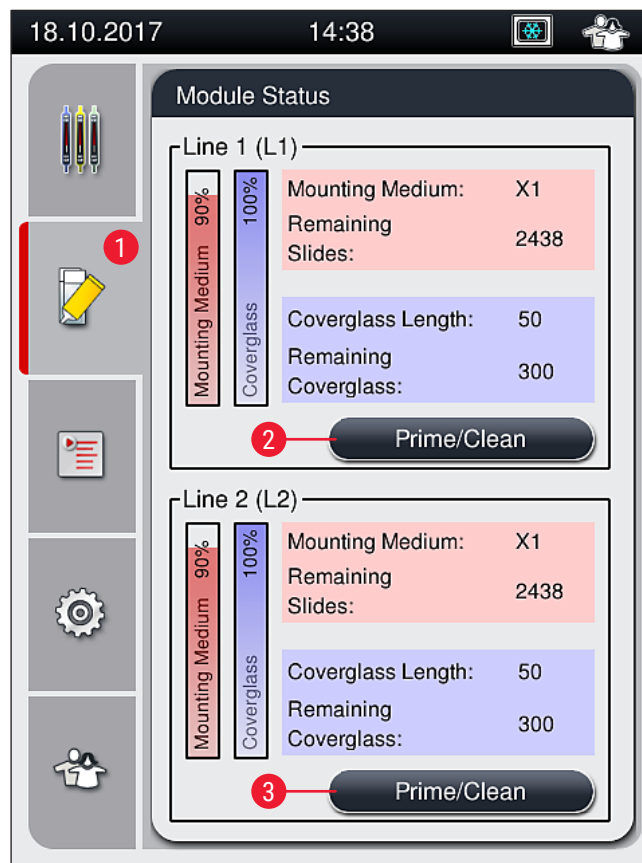

Fig. 95



Fig. 96

3. Observe the following information message (→ Fig. 97).

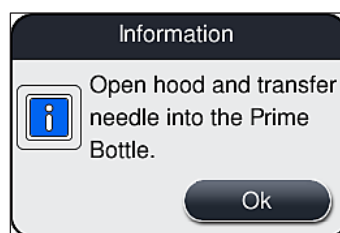

Fig. 97

4. Open the instrument hood and remove the needle (→ Fig. 98-1) from the holder (→ Fig. 98-2).
5. Stick the needle unit (→ Fig. 98-1) in the prime bottle (→ Fig. 98-3) and acknowledge the information message (→ Fig. 97) with **OK**.

**Warning**

Do not close the hood while the needle is inserted in the prime bottle in order to avoid kinking the hose or bending the needle.

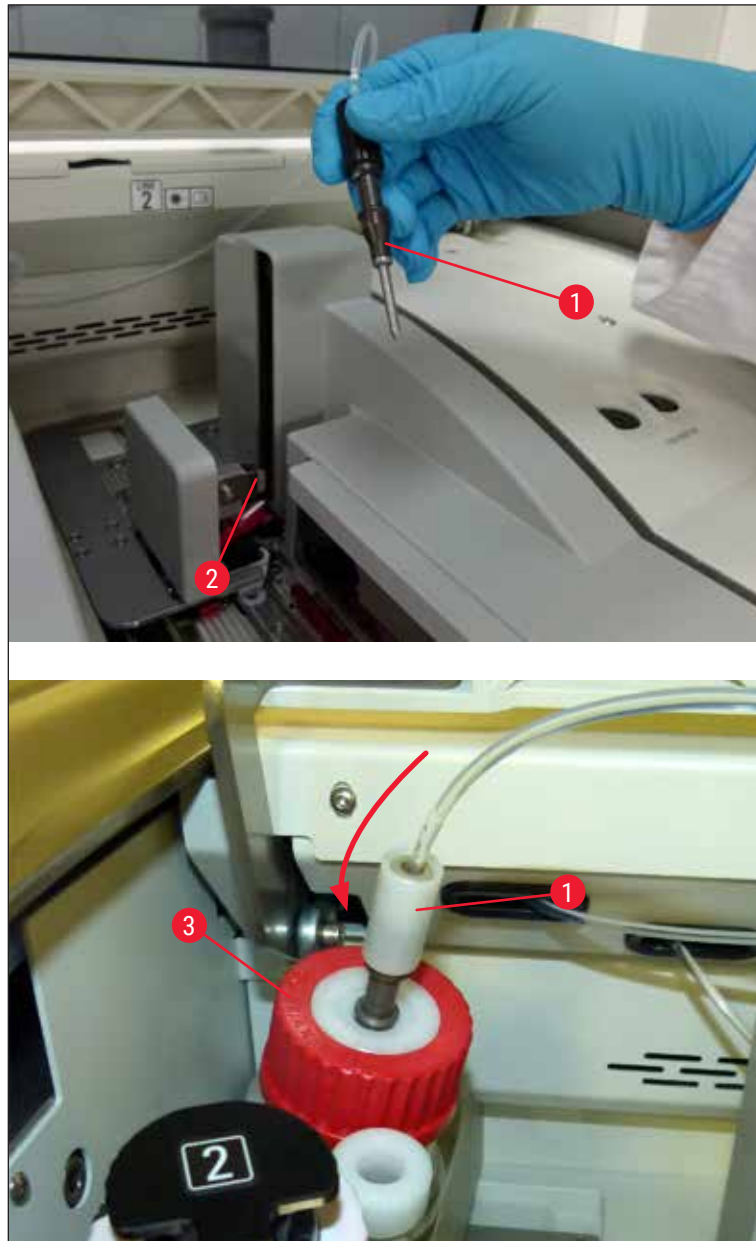

Fig. 98

- ✓ In the following menu (→ Fig. 99), three different priming/cleaning programs are available.



Note

The individual rinsing programs are clarified in the following, using the coverslip line **L1** (→ Fig. 99-1). The same procedures also apply for the coverslip line **L2**.

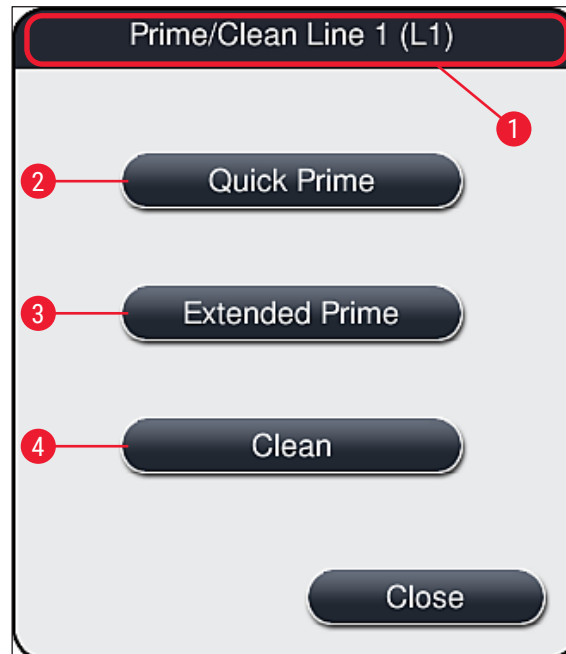

Fig. 99

7.3.1 Quick Prime



Note

At the start of operation, the user is prompted after starting the instrument to carry out the **Quick Prime** (→ Fig. 99-2) rinsing program. This step is necessary to ensure the flow rate of the mounting medium through the needle system. The respective coverslip line is ready to operate only after Quick Prime.

1. After the steps under (→ P. 119 – Priming preparation) have been completed, press the **Quick Prime** (→ Fig. 99-2) button.
2. Priming lasts approx. 35 seconds and uses approx. 2 ml of mounting medium. This quantity is taken into account by the CMS.
3. After the rinsing process has been completed, reinsert the needle unit into the holder (→ Fig. 87) and confirm the corresponding information message with **OK**.

**Note**

The needle has a notch (→ Fig. 87-3) that fits exactly in the holder. The Attention symbol (→ Fig. 87-4) on the holder (→ Fig. 87-2) indicates to the user that utmost care is required when inserting the needle into the holder. The needle must be inserted straight and all the way in order to make sure that no negative impact on the samples arises during processing.

4. Repeat steps 1-3 for the second coverslip line (L2).
5. Finally, close the hood.

✓ After checking the fill level, the instrument is ready to operate and can begin processing.

7.3.2 Extended Prime**Note**

- The **Extended Prime** (→ Fig. 99-3) rinsing program must be carried out after each time a mounting medium bottle is replaced (→ P. 79 – 6.3.1 **Changing the mounting medium bottle**) for the respective coverslip line L1 or L2.
- During an Extended Prime process, mounting medium is pumped through the entire hose system to ensure that no air remains in the hose system as a result of the replacement.
- After the replacement of the mounting medium bottle, the **Quick Prime** (→ Fig. 99-2) and **Clean** (→ Fig. 99-4) buttons are inactive (grayed out).

1. To change the mounting medium bottle, proceed the same way as in (→ P. 79 – 6.3.1 **Changing the mounting medium bottle**) and close the hood.
2. Take note of the information message that follows (→ Fig. 100) and acknowledge with the **Ok** button.

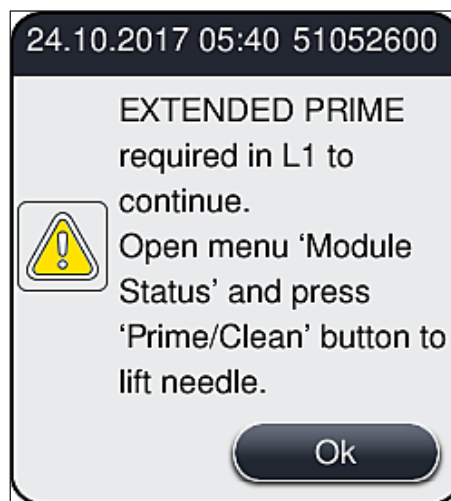

Fig. 100

3. After the steps under (→ P. 119 – **Priming preparation**) have been completed, press the **Extended Prime** (→ Fig. 99-3) button.

4. The priming lasts approx. 3 minutes and 30 seconds and uses approx. 14 ml mounting medium. This quantity is taken into account by the CMS.
5. After the rinsing process has been completed, reinsert the needle unit into the holder and confirm the corresponding information message with **OK**.



Note

The needle has a notch (→ Fig. 87-3) that fits exactly in the holder. The Attention symbol (→ Fig. 87-4) on the holder (→ Fig. 87-2) indicates to the user that utmost care is required when inserting the needle into the holder. The needle must be inserted straight and all the way in order to make sure that no negative impact on the samples arises during processing.

6. Finally, close the hood.

7.3.3 Cleaning the hose system



Note

The **Clean** (→ Fig. 99-4) function is required on demand, e.g. if the mounting quality gets poor (increased bubble formation between the slide and coverslip) or if the HistoCore SPECTRA CV is to be prepared for transport or not in use for a prolonged time frame (longer than 5 days). The mounting medium in the hose system is washed out using a cleaning solution. This process requires a minimum of 125 ml cleaning solution (xylene). The safety notes for safe reagent handling (→ P. 15 – Warnings – Handling reagents) must be observed!

The cleaning using the coverslip line **L1** (→ Fig. 99-1) is clarified in the following. The same procedures also apply for the coverslip line **L2**.

Cleaning preparation

1. Empty prime bottle and reinsert it.
2. Change in the **Module Status** (→ Fig. 95-1) menu.
3. Press the **Prime/Clean** (→ Fig. 95-2) button of the coverslip line **L1**.
4. Note the following information messages (→ Fig. 96), (→ Fig. 97) and (→ Fig. 101) and confirm each with **Ok**.



Fig. 101

5. Remove the cannula from the mounting medium bottle for the coverslip line **L1** and place in the parking location (→ Fig. 59-3).
6. Press the **Clean** (→ Fig. 99-4) button.

7. Take the mounting medium bottle out of the bottle sledge, close and store safely.
8. Fill the cleaning bottle (→ P. 18 – 3.1 Standard delivery – packing list) with at least 125 ml of cleaning solution (xylene) while it is outside the instrument and place it in the position of the mounting medium bottle in the bottle sledge.
9. Take the cannula out of the parking location and insert it into the cleaning bottle.
10. Then confirm the information message (→ Fig. 102) with **OK**.

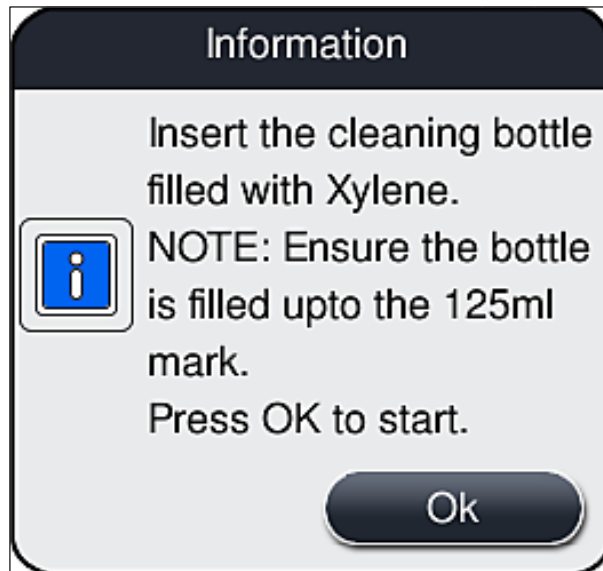

Fig. 102

✓ The cleaning process begins.



Note

The cleaning process lasts approx. 45 minutes. The information message (→ Fig. 103) is displayed on the display while the cleaning process is running. It disappears as soon as the cleaning process is concluded.

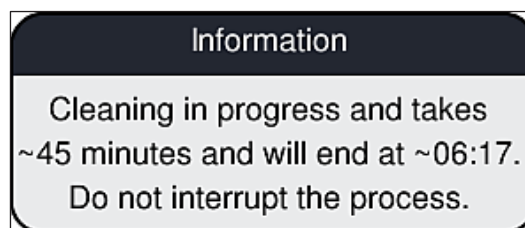

Fig. 103

Cleaning process finished, continuing processing



Note

After the cleaning process has been completed, the user is asked if a new bottle of mounting medium is to be used to continue with the coverslipping (→ Fig. 104).

① If you want to continue with the coverslipping, press the **Yes** (→ Fig. 104-1) button.

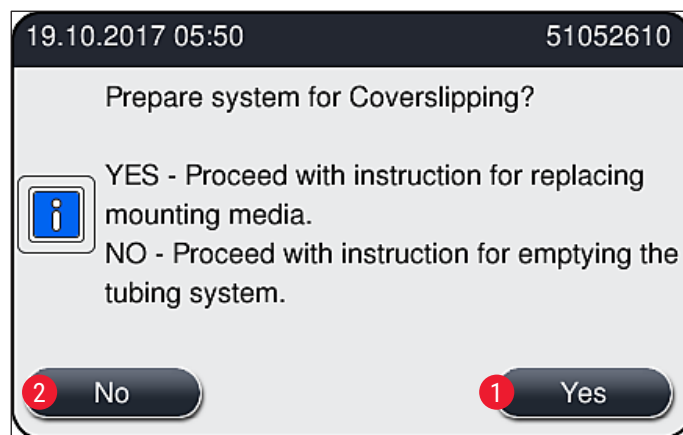

Fig. 104



Note

The **L1** coverslip line must be prepared for processing again by extended priming (→ P. 123 – 7.3.2 [Extended Prime](#)).

- » Following this, the user is prompted to remove the cleaning bottle from the instrument and to insert a new bottle with mounting medium. After the insertion, acknowledge the information message (→ Fig. 105) with **Ok**. Dispose of the contents of the cleaning bottle in accordance with laboratory regulations.

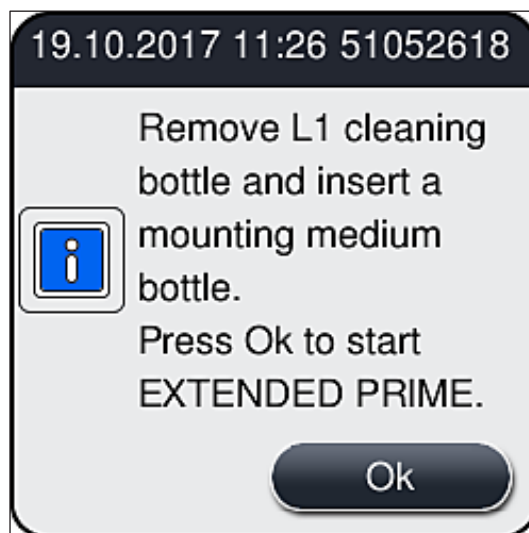

Fig. 105

Cleaning process finished and preparation for transport or storage

1. After the cleaning process has been completed, remove the prime bottle from the instrument and dispose of the contents according to laboratory specifications.
2. Insert the empty prime bottle back into the instrument again.

**Note**

After the cleaning process has been completed, the user is asked if a new bottle of mounting medium is to be used to continue with the coverslipping (→ Fig. 104).

3. If the instrument is to be prepared for transport or storage, press the **No** (→ Fig. 104-2) button.
4. Take note of the next information message (→ Fig. 106), which contains instructions, and acknowledge with the **Ok** button.

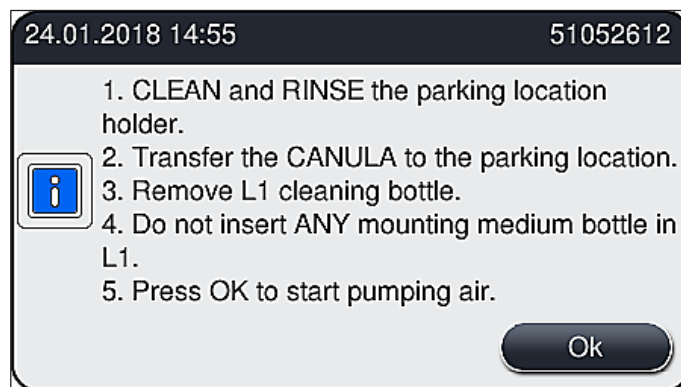

Fig. 106

5. After pressing the **OK** button, the instrument immediately begins pumping air through the hose system.
6. On the screen, an information message (→ Fig. 107) appears informing the user about the duration. This message disappears as soon as air pumping has been completed.

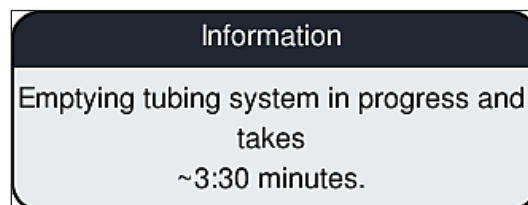

Fig. 107

7. Repeat the procedure with the **L2** coverslip line.
8. After the air pumping has been completed for both coverslip lines, remove the remaining coverglass cartridges and needle cleaning containers and close the instrument hood.

9. The instrument software identifies that no mounting medium bottles, coverglass cartridges and needle cleaning containers are inserted, and indicates this to the user through error messages for each coverslip line. Confirm these messages with **OK**.
10. Finally, shut down the instrument, switch it off at the **power switch** and disconnect it from the power grid.

✓ The instrument is now ready for transport or for storage.

7.3.4 Recommissioning after transport or storage



Note

- For recommissioning after a transport or after long-term storage, proceed as described in (→ P. 24 – 4. Installation and Instrument Setup) and (→ P. 76 – 6. Daily Instrument Setup).
- The internal battery (→ P. 26 – 4.2.1 Internal battery) has to be charged if the instrument has been disconnected from a power supply for 4 weeks. For this purpose, connect the instrument to the socket and switch on the **Main switch** (→ Fig. 1-8). The charging time is approx. 2 hours.

7.4 Recommended cleaning and maintenance intervals



Warning

- It is mandatory to observe and carry out the following cleaning and maintenance intervals and cleaning tasks.
- In case of non-compliance with the maintenance intervals, the proper function of the HistoCore SPECTRA CV by Leica Biosystems GmbH cannot be guaranteed.
- The instrument should be inspected once per year by a qualified service technician authorized by Leica.
- Always wear suitable protective clothing (lab coat, cut-resistant gloves, safety goggles).

To ensure trouble-free operation of the instrument over a long period of time, it is strongly recommended that you conclude a maintenance contract after the warranty period has elapsed. For more information, contact the relevant customer service organization.

7.4.1 Daily cleaning and maintenance

A

Coverglass cartridge:

- Check the coverglass cartridge for broken glass (→ P. 83 – 6.3.3 Checking and replacing the coverglass cartridge) and clean if necessary.
- Check that the coverglass is seated correctly in the coverglass cartridge (→ P. 83 – 6.3.3 Checking and replacing the coverglass cartridge).

B

Waste tray:

- Check the waste tray for broken glass (→ P. 87 – 6.3.4 Emptying the waste tray) and empty it if necessary.

C Pick&Place module:

- Check the skids, suction cups and coverglass sensor pin for residual mountant and broken glass (→ P. 87 – 6.3.5 Inspect Pick&Place module) and clean if necessary (→ P. 115 – 7.2.11 Cleaning the Pick&Place module).
- Replace deformed and/or damaged suction cups (→ P. 116 – 7.2.12 Exchange suction cups).

D Alignment pins:

- Check for residual mountant and clean if necessary (→ Fig. 3-12).

E Coverslip lines L1 and L2:

- Check for surface-dried residual mountant and clean if necessary.

F Reagent vessels in the load drawer:

- Replace the reagent in the reagent vessel (→ P. 32 – 4.6 Refilling consumables).

G Unload drawer:

- Check if there are still racks in the unload drawer and remove (→ P. 108 – 7.2.4 Interior cleaning).

H Surfaces of the instrument:

- Check surfaces of the instrument for residual reagent in the area of the load drawer and clean if necessary. For this purpose, commercial household cleaner can be used (→ P. 106 – 7.2.1 Exterior surfaces, varnished surfaces, instrument hood).

I Prime bottle:

- Check the fill level of the prime bottle and dispose of the contents in accordance with the laboratory specification if necessary.

J Shifter and shifter tongue:

- Check the shifter and shifter tongue (→ Fig. 3-14) for contamination and dried out mounting medium. Soak a lint-free cloth with xylene and remove any mounting medium residue that may be present.

7.4.2 Weekly cleaning and maintenance**A Needle cleaning container:**

- Drain the needle cleaning container, clean and refill with xylene (→ P. 112 – 7.2.9 Filling and changing the needle cleaning container).

B Reagent vessels in the load drawer:

- Empty reagent vessels and clean at a maximum of 65 °C using a lab rinsing machine (→ P. 117 – 7.2.14 Cleaning the reagent vessels).
- Then, refill the reagent vessels and re-insert into the load drawer (→ P. 37 – 4.6.3 Prepare the reagent vessel, fill it and insert it into the load drawer).

C Needle:

- Check the needle for surface-dried residual mountant and clean it with xylene if necessary (→ P. 110 – 7.2.7 Cleaning the needle).

D Touchscreen:

- Check for dirt and clean if necessary. For this purpose, commercial household cleaner can be used (→ P. 107 – 7.2.2 TFT touchscreen).

E Racks:

- For small amounts of dirt: Clean the racks with a lint-free cloth soaked in xylene (→ P. 117 – 7.2.15 Rack and handle).
- In case of heavier soiling: Immerse the rack in xylene for a maximum of 1–2 hours in order to remove dried residual mountant.
- Clean the rack in the dishwasher at 65 °C.

F Workstation:

- Check the transfer station in the HistoCore SPECTRA ST. For additional information, refer to the Instructions for Use of the HistoCore SPECTRA ST.

- G** • Check the drawer inserts for broken glass and clean if necessary (→ P. 108 – 7.2.4 Interior cleaning).

**Warning**

Never place reagent vessels, racks and rack handles in a solvent (xylene) for a prolonged period (e.g. overnight) because this can cause deformation and trouble-free operation can no longer be ensured.

7.4.3 Quarterly cleaning and maintenance**A Changing the active carbon filter:**

- Replace the active carbon filter (→ P. 118 – 7.2.16 Changing the active carbon filter).

7.4.4 Cleaning and maintenance as necessary**Warning**

- Attention: Wear cut-resistant gloves (→ P. 18 – 3.1 Standard delivery – packing list)!
- Clean the interior of the instrument in the event of broken glass.
- A lint-free cloth moistened with xylene can be used to clean off any spilled mounting media. You can use the brush included in the delivery package to brush glass debris without residue of mounting media or loose glass debris toward the drawer outlet and then use a commercially available vacuum cleaner to carefully clean them up.

- A** • Make sure the instrument is idle (→ P. 77 – 6.2 Switching on and shutting down the instrument):
 - Cover reagent vessels
 - Ensure there is enough xylene in the needle cleaning container to prevent the needle from drying out (→ P. 82 – 6.3.2 Monitoring and refilling of the needle cleaning container).

- B** • Prime the hose system with xylene (→ P. 124 – 7.3.3 Cleaning the hose system).

C Pick&Place module:

- Replace the suction cups if they have severe deformation or are very dirty (→ P. 116 – 7.2.12 Exchange suction cups).

- D** • Cleaning the interior of the instrument (→ P. 108 – 7.2.4 Interior cleaning).

- E** To ensure a smooth operation of the instrument software, the instrument must be restarted at least every 3 days (→ P. 98 – 6.6.2 Coverslipping operation finished).

8. Malfunctions and Troubleshooting

8.1 Troubleshooting

Problem/malfunction	Possible cause	Correction
Black screen	<ul style="list-style-type: none"> • Software crash • Power failure 	<ul style="list-style-type: none"> • Remove all racks from the instrument and restart the instrument. • See (→ P. 136 – 8.2 Power failure scenario and instrument failure)
Needle cleaning container cannot be removed using the knurled screw	<ul style="list-style-type: none"> • Needle cleaning container is stuck due to mounting medium residue in the holder. 	<ul style="list-style-type: none"> • Remove the needle cleaning unit and immerse it in xylene until the needle cleaning container has loosened and can be taken out (→ P. 112 – 7.2.10 Removing the complete unit of the needle cleaning container).
Consumables cannot be scanned	<ul style="list-style-type: none"> • RFID chip is dirty • RFID chip is defective 	<ul style="list-style-type: none"> • Carefully remove any contamination from the RFID chip and re-scan the consumables by closing the hood. • Try again with new consumables. • There may be an instrument defect present if the problem persists. Please contact Leica Service.
Load/unload drawer is sticking	<ul style="list-style-type: none"> • Possible contamination in or on the respective drawer 	<ul style="list-style-type: none"> • Carefully remove any contamination (mounting medium residue, glass splinters) (→ P. 106 – 7.1 Important notes about cleaning this instrument), remove all racks from the instrument and restart the instrument.
Transport arm reports an error	<ul style="list-style-type: none"> • Malfunction in the instrument 	<ul style="list-style-type: none"> • Follow the instructions in (→ P. 138 – 8.3 Manual removal of a rack in the event of instrument malfunctions) and pull the transport arm to the unload drawer. Remove the rack from the transport arm.

Problem/malfunction	Possible cause	Correction
Intact coverglass is disposed into the waste tray.	<ul style="list-style-type: none"> Coverglass sensor pin contaminated. 	<ul style="list-style-type: none"> Check the coverglass sensor pin for dirt; if necessary, clean it with a lint-free cloth soaked in xylene (→ P. 115 – 7.2.11 Cleaning the Pick&Place module).
Air bubbles between the specimen and coverglass	<ul style="list-style-type: none"> Needle partially stuck/blocked A reagent not compatible with the mounting medium has been filled in the reagent vessel in the load drawer. The needle is bent. The specimens were not kept sufficiently moist The coverslipping operation has been interrupted by the user and resumed. Leaks in the mountant hose system. 	<ul style="list-style-type: none"> Remove any stuck mounting medium and perform a Quick Prime (→ P. 122 – 7.3.1 Quick Prime). If the problem persists, carry out a complete cleaning of the hose system (→ P. 124 – 7.3.3 Cleaning the hose system). Leica recommends the use of xylene for the reagent vessels in the load drawer. Ensure that xylene is being used both in the reagent vessel in the HistoCore SPECTRA CV load drawer and in the last steps of the preceding staining process in the HistoCore SPECTRA ST. Dispose of non-compatible reagent in accordance with the applicable local regulations, clean the reagent vessel and fill it with xylene outside the instrument. Finally, set the reagent vessels back in the load drawer. Notify Leica Service and replace the bent needle with a new one. Check the fill level of the reagent vessels in the load drawer (→ P. 38 – Correct fill level of the reagent vessels) and refill reagent if necessary (→ P. 15 – Warnings – Handling reagents). Problem should no longer occur for the next rack. In general, the coverslipping operation should not be interrupted to perform tasks such as refilling consumables. Remove mounting medium bottle, check that the cannula fits correctly and ensure that you can feel it click in place.

Problem/malfunction	Possible cause	Correction
Insufficient mounting medium is applied to the slides	<ul style="list-style-type: none"> Quantity of mounting medium is set too low. 	<ul style="list-style-type: none"> Adjust the application quantity of the mounting medium in the parameter set (→ P. 71 – 5.9.5 Adjustment of the application volume) or change it using the Volume calibration (→ P. 59 – 5.8.6 Volume calibration) menu.
Too much mounting medium is dispensed on the slides, or there is excess mounting medium on the coverglass	<ul style="list-style-type: none"> Quantity of mounting medium is set too high. Mounting medium residue on the shifter or the shifter tongue (also below the shifter tongue). 	<ul style="list-style-type: none"> Adjust the application quantity of the mounting medium in the parameter set (→ P. 71 – 5.9.5 Adjustment of the application volume) or change it using the Volume calibration (→ P. 59 – 5.8.6 Volume calibration) menu. Check the shifter and shifter tongue (also below the shifter tongue) for contamination, clean with a lint-free cloth moistened in xylene if appropriate
During application of the mounting medium, the specimen on the slide was damaged	<ul style="list-style-type: none"> Needle height not set correctly. 	<ul style="list-style-type: none"> Do not begin any further coverslipping operations in the respective coverslip line and notify Leica Service. The needle height can be changed and calibrated only by Leica Service.
The Pick&Place module allows coverglass to fall	<ul style="list-style-type: none"> Dirty or deformed suction cups coverglass in the magazine have been moistened and can no longer be removed individually. 	<ul style="list-style-type: none"> Check the suction cups on the Pick&Place module for contamination and deformation (→ P. 115 – 7.2.11 Cleaning the Pick&Place module). Clean the suction cups or replace them with new ones (→ P. 116 – 7.2.12 Exchange suction cups). Additionally, observe the procedure in (→ P. 140 – 8.3.1 Malfunction at the coverglass receptacle). Remove the cover slip magazine and replace it with a new one (→ P. 83 – 6.3.3 Checking and replacing the coverglass cartridge).

Problem/malfunction	Possible cause	Correction
Drying out of the needle	<ul style="list-style-type: none"> Needle is not lowered into the needle cleaning container automatically (i.e. after instrument malfunction or rack rescue). Malfunction in a coverslip line, the needle could not be moved to the needle cleaning container. 	<ul style="list-style-type: none"> Open the Module Status menu and click on the Prime/Clean button of the affected coverslipping line. Press the Close button (→ Fig. 98). Observe if the needle has been lowered into the needle cleaning container. If problem persists, place needle manually into the needle cleaning container, make sure that it is sufficiently filled with xylene and call a Leica service technician. Remove the needle from the needle holder and set it in the needle cleaning container.
The fill level indicated in the Module Status for the mounting medium bottle is too low	<ul style="list-style-type: none"> Quick or extended priming has failed multiple times. 	<ul style="list-style-type: none"> Upon each priming attempt, the instrument software takes the amount necessary for priming from the fill level of the mounting medium bottle. Change the mounting medium bottle. Check the needle's ability to allow material to flow and, if necessary, place it in xylene for a longer period of time. If the needle remains clogged for a prolonged period, arrange for a Leica service technician to replace the needle unit.
Error message "L1/L2 mounting medium not detected"	<ul style="list-style-type: none"> Bottle sledge (→ Fig. 16-1) not inserted until it clicks in place. 	<ul style="list-style-type: none"> Slide the bottle sledge (→ Fig. 16-1) back until you feel it click into place.
Error message "Unload drawer malfunction" after the transport of a rack into the unload drawer	<ul style="list-style-type: none"> RFID chip in the rack handle is defective. 	<ul style="list-style-type: none"> Observe the message and remove all racks from the unload drawer. Disengage the defective rack handle from the rack (→ P. 91 – Detach the handle from the rack.) and dispose of it in accordance with applicable local laboratory regulations.

Problem/malfunction	Possible cause	Correction
Oven temperature cannot be reached after rack rescue	<ul style="list-style-type: none"> Oven door not closed properly 	<ul style="list-style-type: none"> Observe message on the screen. Open access to the oven (→ Fig. 123-1) Check that oven door is properly closed (→ Fig. 123-2) If problem persists, call a Leica Service technician.
No coverglass on slide	<ul style="list-style-type: none"> Slide was not removed from the coverslip line as requested in the message (→ Fig. 111) on the screen. 	<ul style="list-style-type: none"> Follow the guidance on the screen (→ Fig. 115-2). Recover slip unconverted slides.
Empty coverglass cartridge	<ul style="list-style-type: none"> The user has not topped up the magazine, but pressed Yes or removed too many coverglasses after the message of detecting too many coverglasses in the magazine. 	<ul style="list-style-type: none"> Insert a new coverglass magazine. Check rack for unconverted slides!



Note

Display messages for certain failures contain image sequences to guide the user through the troubleshooting process (→ Fig. 108).



Fig. 108

8.2 Power failure scenario and instrument failure

**Warning**

In the event of a software crash or an instrument malfunction, a previously defined audible warning signal will sound. In this case, the user has to remove all racks from both instruments, HistoCore SPECTRA CV and HistoCore SPECTRA ST, as well as restart the instruments afterwards.

**Note**

- In the event of a prolonged power failure (> 3 sec.), the internal battery ensures that the HistoCore SPECTRA CV is shut down in a controlled manner and any negative impact on the specimens is avoided.
- The fully charged internal battery can bridge two successive power failures (> 3 sec.). After two successive power failures and once the power supply has been re-established, the internal battery is recharged when the instrument is started up. The user is notified of the charging process by a note on the screen. The instrument is not ready for use again until after charging.
- After the power supply has been restored, the instrument automatic performs a restart. The user is notified of the power failure by an information message (→ Fig. 109) on the screen, and the event is entered into the event log.
- An external UPS (uninterruptible power supply) ensures a long-term bypass, depending on the specifications of the connected UPS (→ P. 26 – 4.2.2 Using an external uninterruptible power supply (UPS)).

In case of a power failure, the instrument carries out the following steps regardless of whether just one or both coverslip lines are in use:

1. The software shuts the screen down.
2. The slides currently being processed in the coverslip lines **L1** and **L2** are still completely covered and pushed back into the rack.
3. The racks from both coverslip lines are transported by the gripper arm into the unload drawer. After this, the gripper arm moves into the secure position behind the oven.

**Note**

In rare cases, it may happen that both racks cannot be transported into the output drawer. In these cases, both the elevator and the rotator must be checked by the user and the remaining racks must be removed (→ P. 138 – 8.3 Manual removal of a rack in the event of instrument malfunctions).

4. The instrument is then shut down by the software in a controlled manner (→ P. 30 – 4.5 Switching on and shutting down the instrument).
- ① After power supply has been restored, the instrument restarts automatically. An audible warning signal sounds and a warning message is displayed on the display (→ Fig. 109).

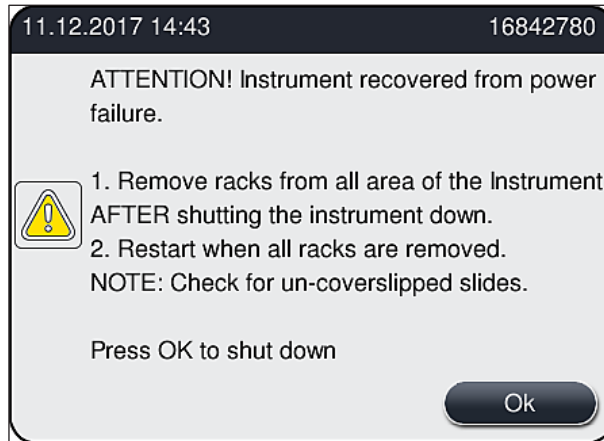

Fig. 109

5. Confirm this message with **OK**, whereupon the instrument shuts down in a controlled manner.

Then follow the instructions in the information message (→ Fig. 109) and remove the slides from the instrument.

**Note**

- After the restart of the instrument, the oven is shut down, and the user must reactivate it in the Oven Settings menu (→ P. 55 – 5.8.5 Oven settings). The user is notified by a information message upon the setting of a rack.
- For a safe and easy removal of the racks from the instrument, the instrument must be shut down. Following shutting down, the user can, for example, easily move the transport arm in order to carry out the necessary steps for removing the racks.
- Check the removed racks for un-coverslipped slides and coverslip those slides manually. In doing so, observe the sequence in which the individual slides are processed in the coverslipping process (→ P. 95 – 6.6 Starting the coverslipping operation) and (→ Fig. 74).
- The following chapters shall be observed for removal of the rack remaining in the instrument.

Position	See
Load drawer	(→ P. 138 – 8.3 Manual removal of a rack in the event of instrument malfunctions)
Rotator	(→ P. 150 – 8.3.5 Removal of the rack from the rotator)
Elevator	(→ P. 142 – 8.3.2 Removing a rack from the elevator of the coverslip line)
Transport arm	(→ P. 138 – 8.3 Manual removal of a rack in the event of instrument malfunctions)
Oven	(→ 8.3.4 Removing the rack from the oven or from behind the oven)
Unload drawer	(→ P. 138 – 8.3 Manual removal of a rack in the event of instrument malfunctions)

8.3 Manual removal of a rack in the event of instrument malfunctions



Warning

- Risk of injury! Always wear personal protective clothing (lab coat, cut-resistant gloves, safety goggles)!
- We recommend calling in a second person for support.
- The instrument software provides instructions on the screen. Compliance with these is mandatory.
- If a manual removal of a rack from the right-side **L2** coverslip line is necessary, the transport of racks in and out of the oven is interrupted for safety reasons. racks may remain in the oven for longer than 5 minutes as a result.



Note

In the event of instrument malfunctions requiring the user to remove a rack from inside the instrument manually, note that the instrument software cannot precisely locate a rack inside the instrument and therefore only gives general instructions regarding manual removal. If the user can readily identify the rack to be removed upon looking inside the instrument, the user can carefully remove it without following the instruction on screen if there is no risk of damage to the specimens or the instrument from doing so.

Manual removal of a rack from the interior of the instrument:

1. Open the load drawer.
2. Open the unload drawer and remove all racks (→ Fig. 110-1).
3. Pull the red retaining lever upwards (→ Fig. 110-2). Pull out the drawer entirely and lower it into the rescue position (→ Fig. 110-3).
4. Locate rack by looking through the opening of the unload drawer. (→ Fig. 110-4).
5. Insert your hand into the opening and try carefully to feel around for the rack.



Warning

- There can still be un-coverslipped slides in the racks. Proceed with utmost caution and care.
- If the elevator interferes with the removal of a rack, then the user must manually lift the elevator upward (→ P. 142 – 8.3.2 Removing a rack from the elevator of the coverslip line).

6. Lift the gripper with the rack to the very top if necessary and push/pull the transport arm (with gripper) to the center of the instrument (→ Fig. 110-5).
7. Carefully lower the gripper with rack downwards (→ Fig. 110-6).
8. The rack is now in a position (→ Fig. 110-7) that facilitates secure removal.
9. With one hand, secure the transport arm (with gripper) so it does not fall down and grasp the front part of the rack with the other hand.
10. Lightly lift the front of the rack to release it from the gripper of the transport arm (→ Fig. 110-8).
11. Finally, hold the rack upwards in a tilted fashion (→ Fig. 110-9) and pull it forwards out of the gripper (→ Fig. 110-10).
12. Place the transport arm (with gripper) in the secure position behind the oven.
13. Close the unload drawer and acknowledge the information message that follows with **Ok**.
14. Afterwards, the instrument is re-initialized.
15. A **Quick Prime** (→ P. 122 – 7.3.1 Quick Prime) must always be performed after initializing.



Note

Place the extracted rack outside of the instrument and secure the slide against drying out.

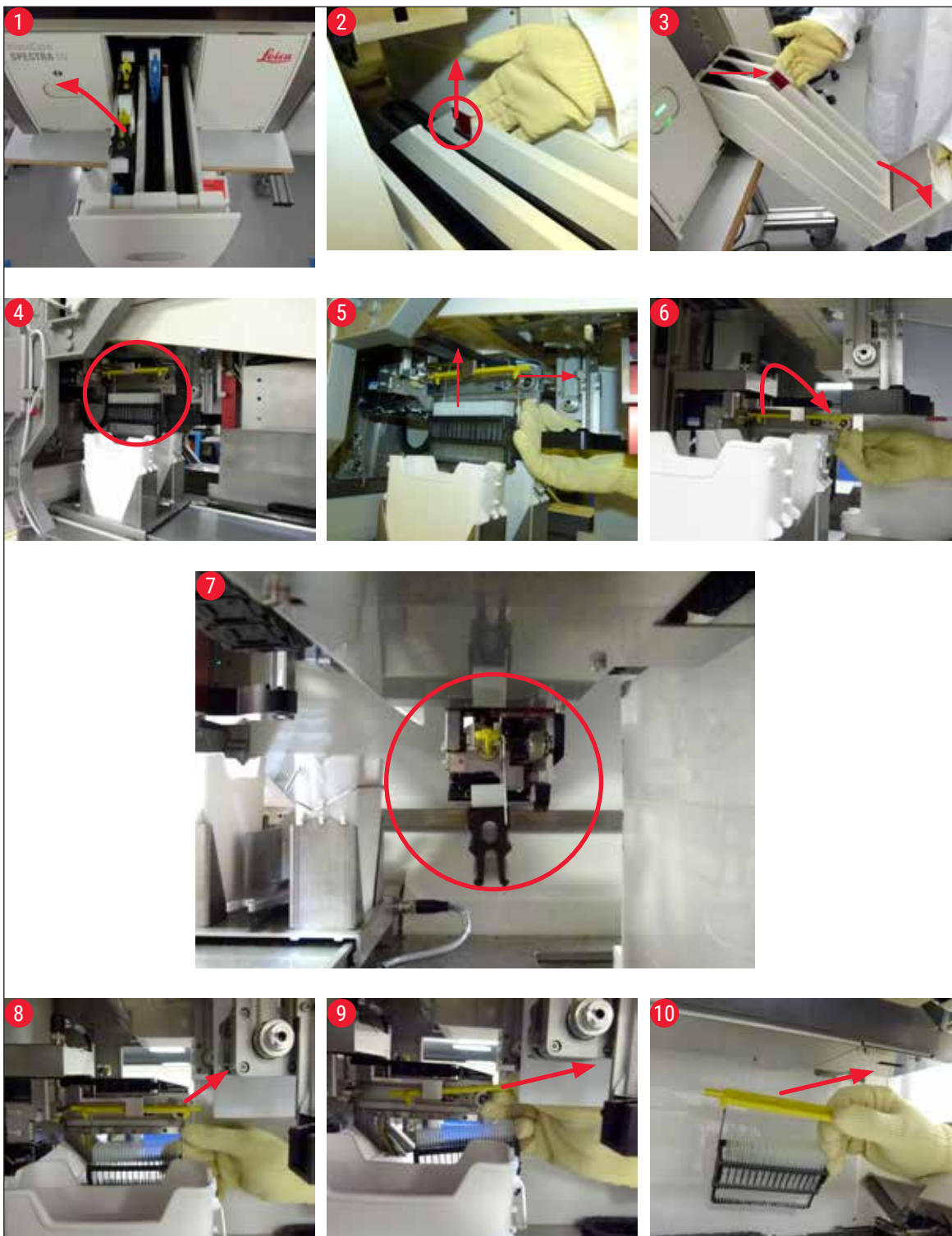

Fig. 110

8.3.1 Malfunction at the coverglass receptacle

If the **Pick&Place module** loses a coverglass during transport to the slide or if the **Pick&Place module** cannot remove a coverglass from the coverglass cartridge after 3 attempts, the user is notified of this through an error message (→ Fig. 111).

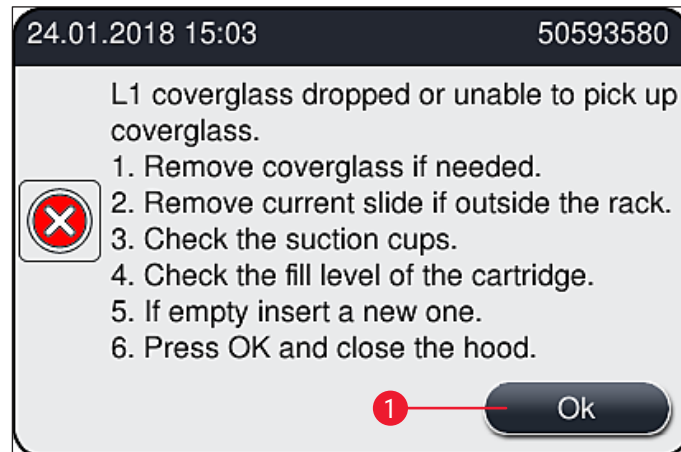

Fig. 111



Note

Processing in the respective coverslip line is interrupted in order to prevent damage to the specimens. Specimens may become dried out during the interruption.

- ① If this message (→ Fig. 111) is displayed, the user must first check whether a coverglass has been lost during transport to the slide or whether the **Pick&Place module** was unable to take a coverglass from the coverglass cartridge.
 1. To do this, start by opening the hood of the instrument and checking whether or not a coverglass has been lost while being transported to the slide.
 2. To remove the slide, press the red bar to the far right (→ Fig. 112-1) and hold it in this position.
 3. Make sure that the shifter (→ Fig. 112-2) does not obstruct the safe removal of the slide. Move the shifter all the way forward or back if necessary.
 4. Carefully remove the slide that has not yet been coverslipped from the instrument (→ Fig. 112-3) and store it safely outside the instrument. After correcting the malfunction, the slide can be coverslipped manually.



Fig. 112

5. Check the coverslip line for broken glass and clean if necessary.
6. If the **Pick&Place module** was unable to remove a coverglass from the coverglass cartridge, check the suction cups on the **Pick&Place module** for contamination or damage and, if necessary, clean or replace the suction cups with two new ones.
7. Then check the fill level of the coverglass cartridge as well. If there is no longer enough coverglass present, insert a new coverglass cartridge.
8. If the steps listed above have been carried out, press the **OK** button and close the hood.
9. The instrument software performs a fill level scan. The user receives an information message when the check is finished (→ Fig. 113).
10. If the processing was interrupted for too long, it can be canceled by pressing **Yes** (→ Fig. 113-1). The rack in question is transported to the unload drawer and can be removed by the user there.
11. To continue processing, press the **No** (→ Fig. 113-2) button. Processing is continued as normal.

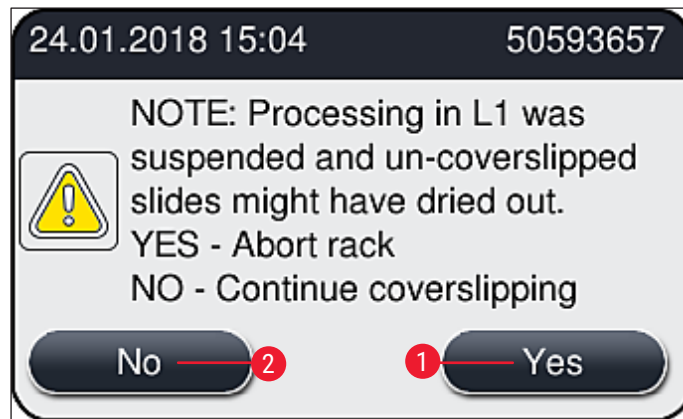

Fig. 113

**Note**

If the error cannot be remedied by the user using the specified procedure, notify a Leica service technician and remove the coverslip line in question from service for the time being.

8.3.2 Removing a rack from the elevator of the coverslip line**Warning**

- If, during operation, a malfunction occurs in one of the two coverslip lines, the user will receive information messages from the instrument, which will provide the user with instructions for the potentially necessary removal of a rack from the elevator. Paying attention to the displayed messages is mandatory.
- Always read the messages on the display first, then perform the task(s) described and then confirm the messages (if applicable) to continue with the rescue process.
- Risk of injury! Always wear personal protective clothing (lab coat, cut-resistant gloves and safety goggles)!
- Specimens may become dried out during the interruption.

1. Read and confirm the messages, then open the hood.
2. Observe the following message. Before confirming, execute the tasks stated in the message. Take the needle of the respective coverslip line from its holder laterally (→ Fig. 114-1) and insert it into the parking location (→ Fig. 114-2).

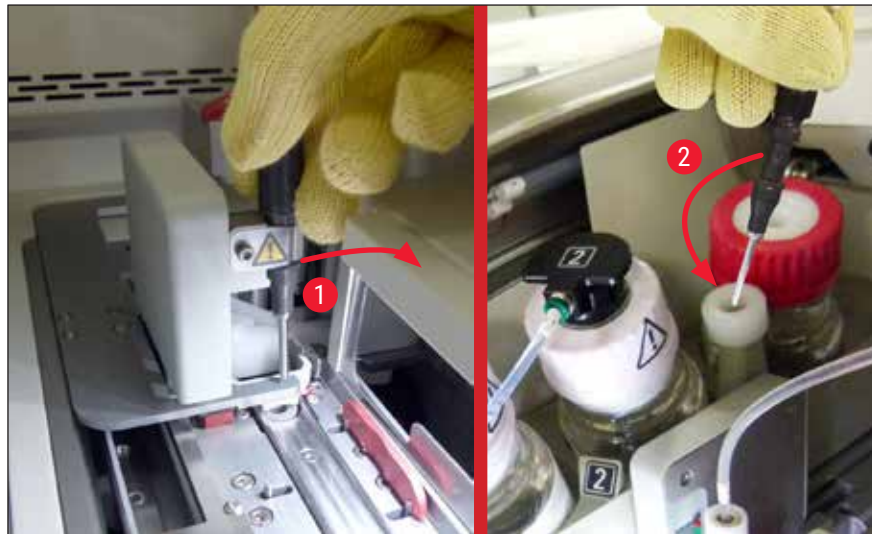

Fig. 114

3. Check the respective coverslip line for possible blockage and remove it carefully (→ Fig. 115-1).
4. If in the way, move the Pick&Place module to the waste tray (→ Fig. 115-2).
5. Confirm the message by clicking **Ok**.

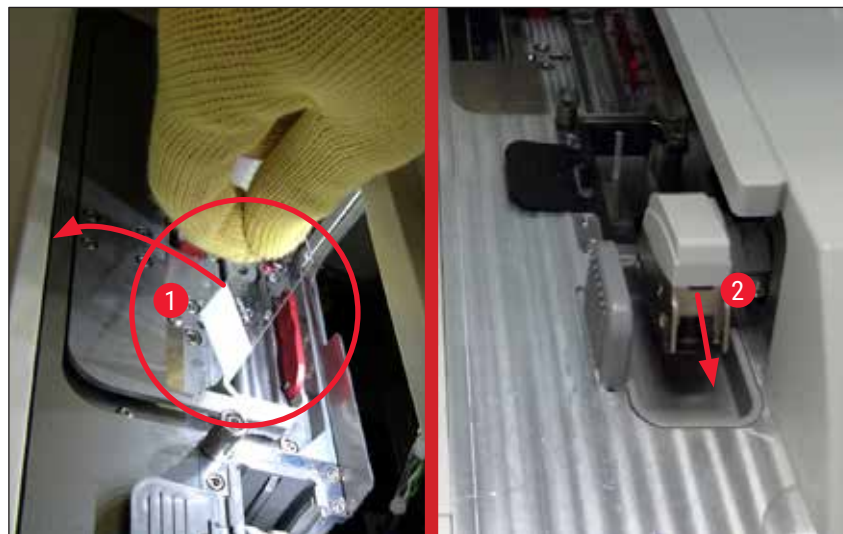

Fig. 115

6. Take note of the following message and close the hood.
7. The instrument now attempts to move the rack to the uppermost position.
8. After a short period of time, a message appears on the display. Reopen the hood and check whether the rack is in the uppermost position.

**Note**

If the instrument can not move the rack to the uppermost position (due to i.e. blocking slides), the following three steps have to be performed before attempting to remove the rack.

9. If a slide has canted in the coverslip line (→ Fig. 116-1), push the shifter (→ Fig. 116-2) forwards. To do so, press the red bar to the far right (→ Fig. 112-1) and hold it in this position. Then carefully pull the canted slide forwards (→ Fig. 116-3), remove it from the instrument (→ Fig. 116-4) and coverslip it manually.

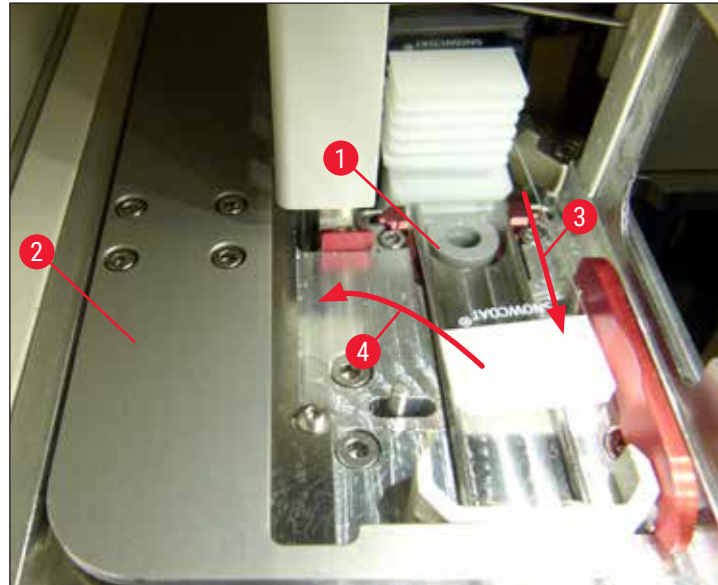

Fig. 116

10. Align the shifter (→ Fig. 117-1) with the red barrier (→ Fig. 117-2). This ensures that user can move the elevator upwards manually.

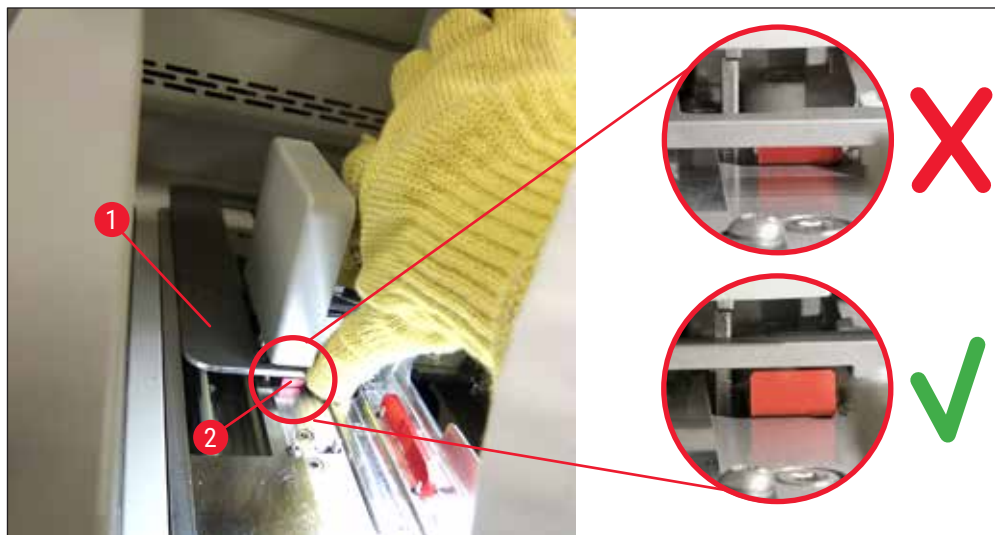

Fig. 117

11. Pull now the elevator upwards manually. To do so, grasp the red lever (→ Fig. 118-1) and carefully pull the elevator with the rack upwards.

**Warning**

Carefully pull the elevator upwards slowly and without jerky movements. Do not apply any force. Pay attention to protruding or interfering slides and push them carefully back into the rack (→ Fig. 118).

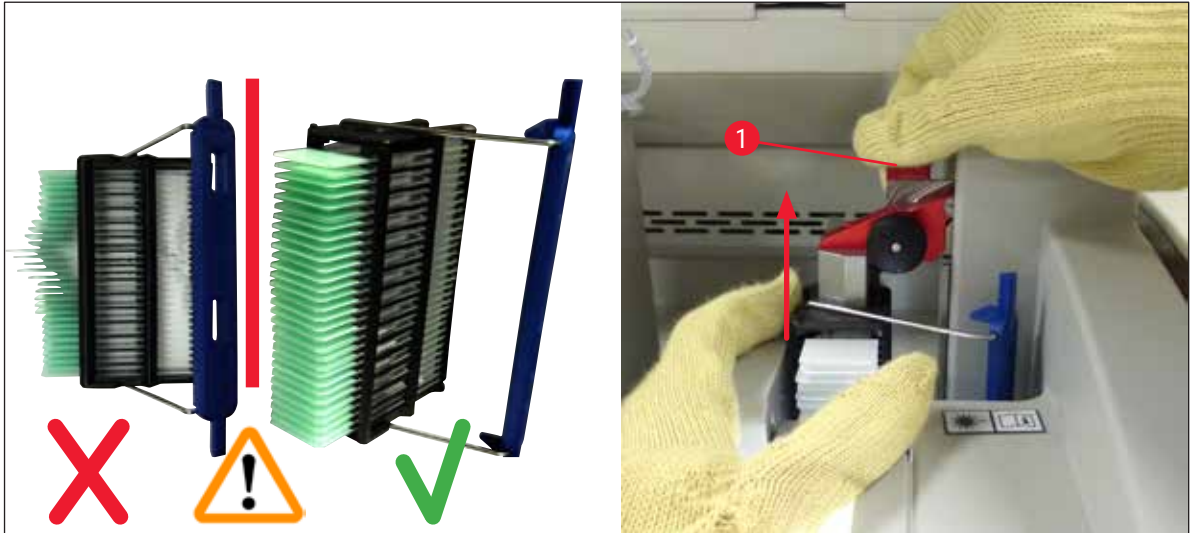

Fig. 118

12. Observe the following message. Before confirming, execute the tasks stated in the message.
13. Hold the rack with one hand (→ Fig. 119-1), loosen the locking mechanism by pulling on the black knob (→ Fig. 119-2) at the elevator and fold it back (→ Fig. 119-3).
14. Continue to hold the elevator (→ Fig. 119-4) and remove the rack from the elevator with the other hand (→ Fig. 119-5). Make sure that no slides slip out of the rack.
15. Now release the elevator, take the rack out of the instrument and confirm the message.

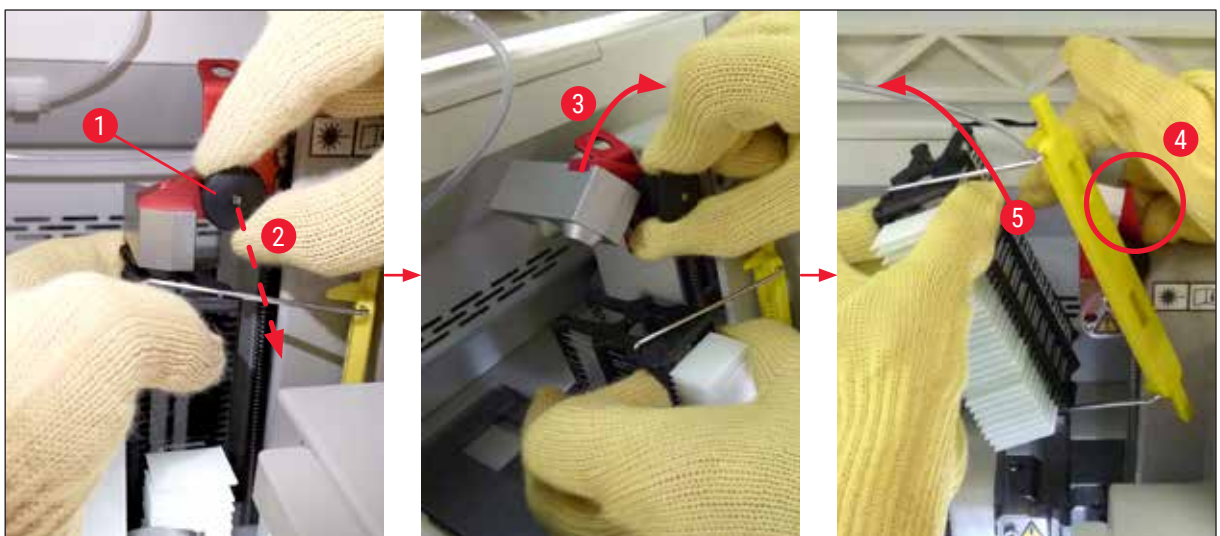

Fig. 119

16. Follow the instructions on the display and close the locking mechanism of the elevator again (→ Fig. 120-1) and push the elevator a few centimeters downward (→ Fig. 120-2). Confirm the message after completing the task.



Fig. 120

17. The next message asks the user to remove the needle from the parking location (→ Fig. 121-1) and insert it into the holder (→ Fig. 121-2) of the coverslip line. Make sure that the needle is positioned correctly and confirm the message.



Fig. 121

18. Close the hood.
19. After the hood has been closed, a new message appears informing the user to check for uncoverslipped slides (→ Fig. 122-1) in the removed rack, considering the coverslipping sequence (→ Fig. 74). Uncoverslipped slides have to be coverslipped immediately to avoid drying out of the specimen. Confirm the message.

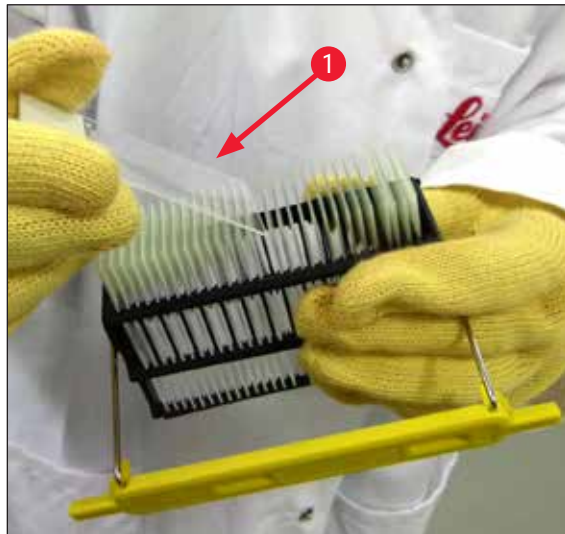

Fig. 122

**Note**

- After initializing the instrument again, the coverslip line can be used for processing again.
- If the coverslip line continues to be defective, notify Leica Service. Do not continue to use the defective coverslip line in the meantime.

8.3.3 Removing the rack from the lower area of the left elevator

1. Moving the unload drawer into removal position (rescue position)
2. Reach to the left elevator with your left hand through the unload drawer (or through the load drawer after the vessels have been removed).
3. Press the rack downwards and out of the elevator (hold the holder from below using your little finger) and push it toward the back.
4. The rack can also be removed upwards using the coverslip line and the elevator. To do so, please note the action as described in step 2.

8.3.4 Removing the rack from the oven or from behind the oven



Warning

- Danger of explosion! Easily flammable reagents in the oven
- There is a potential for respiratory tract irritation through evaporating flammable reagents.
- Caution! Hot surfaces! The oven door and the interior of the oven are hot. Avoid contact if possible to prevent burns.

1. Open access to the oven (→ Fig. 123-1).
2. Open the oven door (→ Fig. 123-2) fully upwards (→ Fig. 123-3), the magnet holds the oven door in place (→ Fig. 123-4).
3. If the rack is not attached to the gripper (→ Fig. 123-5), the rack can be removed from the oven (→ Fig. 123-6).



Warning

It is possible that the mounting medium is not yet sufficiently dried. Because of this, remove the rack only with great caution to prevent sliding of the coverglasses on the slides.

4. Store the rack safely outside the instrument.
5. Detach the oven door from the magnet carefully (→ Fig. 123-7) and close it (→ Fig. 123-8).



Warning

Close the oven door carefully to prevent crushing your hand.



Note

You must feel the oven door click into place when closing.

6. Finally, close the access to the oven (→ Fig. 123-1).

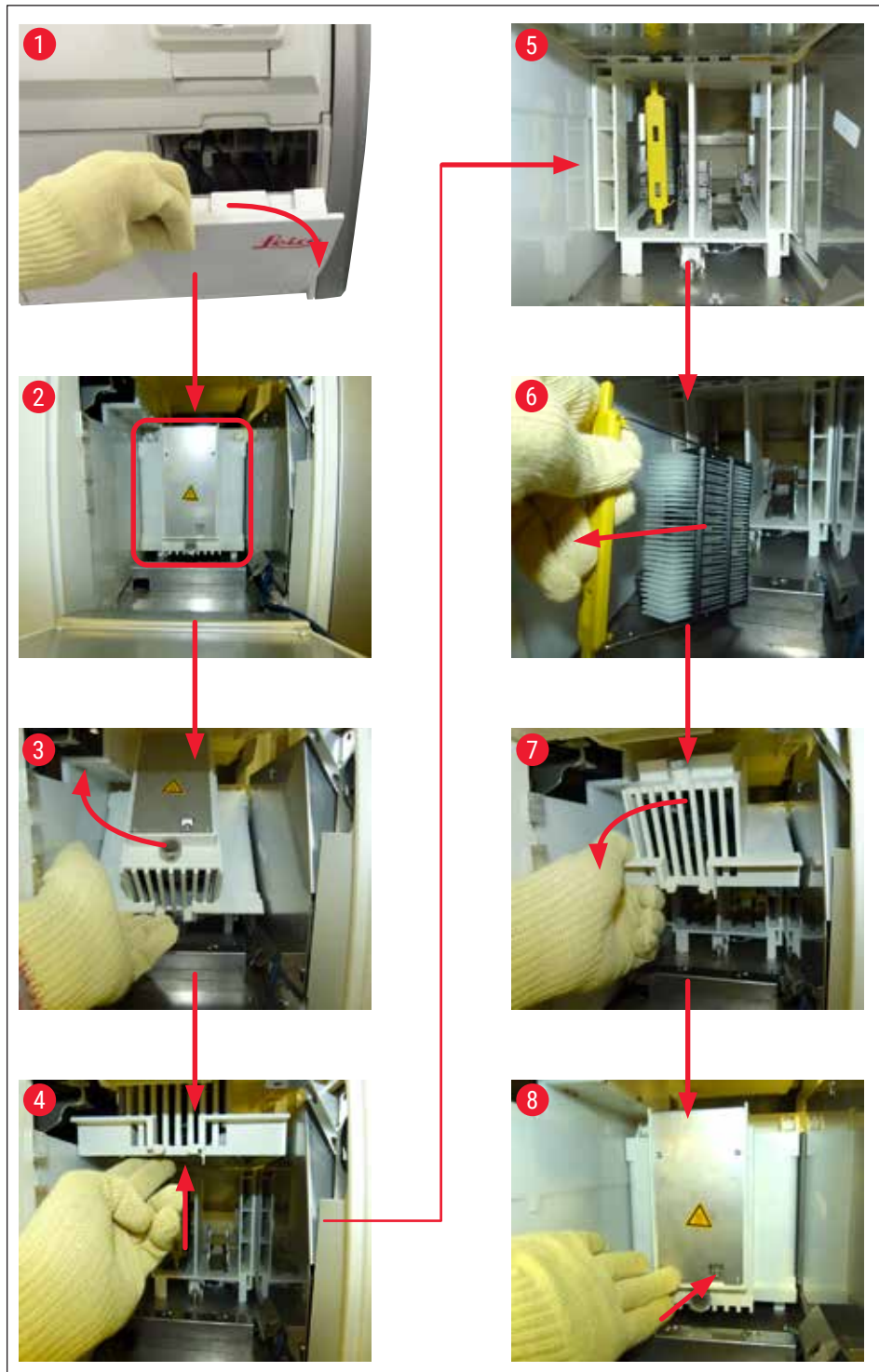

Fig. 123

8.3.5 Removal of the rack from the rotator

1. Moving the unload drawer into removal position (rescue position).
2. Insert your hand carefully into the instrument and remove the rack (→ Fig. 124-1) from the rotator (→ Fig. 124-2).



Fig. 124

8.3.6 Removal of the rack from the gripper of the transport arm above the rotator

1. Moving the unload drawer into removal position (rescue position).
2. Insert your hand carefully into the instrument and remove the rack from the gripper of the transport arm. To do so, grasp the handle and pull it forward, along with the rack, toward the load drawer.

8.3.7 Removal of a rack from the transfer station of the HistoCore SPECTRA ST

- ① If a malfunction occurs in workstation mode while the transfer device of the HistoCore SPECTRA ST transfers a rack to the HistoCore SPECTRA CV using the transfer station, the user must check where the rack is located.

1. Open the hood of the HistoCore SPECTRA ST.
2. Check whether the rack is still visible from the transfer station (→ Fig. 125-1).

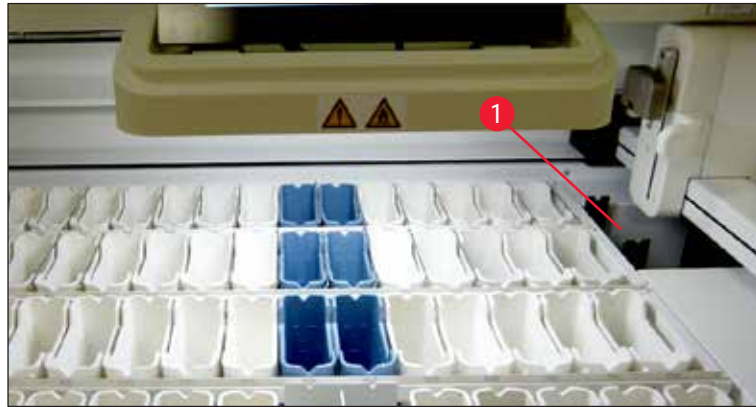

Fig. 125

3. If this is the case, push the sledge (→ Fig. 126-1) of the transfer station back into the HistoCore SPECTRA ST manually (→ Fig. 126-2) and remove the rack (→ Fig. 126-3) from the holder (→ Fig. 126-4).

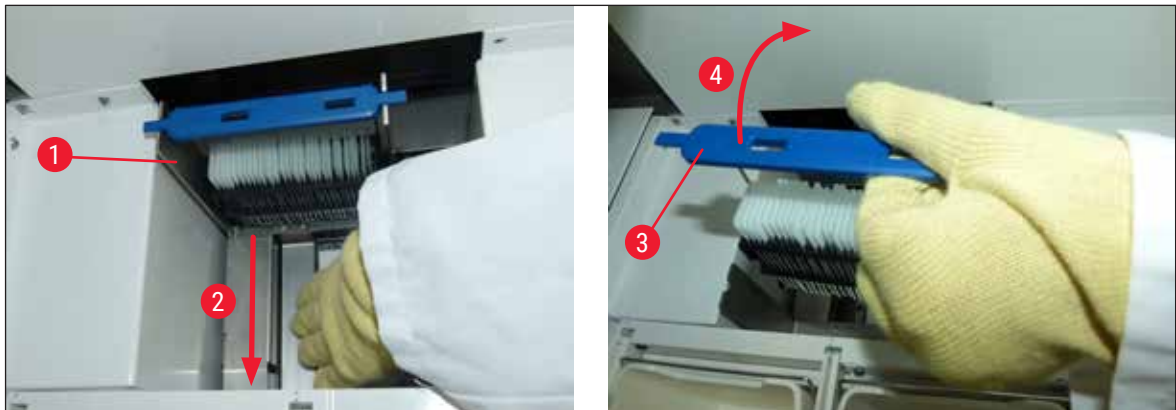

Fig. 126

4. Following this, remove the rack from the instrument and store it safely.
5. After the instrument fault has been corrected, insert the rack in the load drawer of the HistoCore SPECTRA CV to start processing.

8.4 Replacing main fuses



Warning

The instrument should be shut down using the **Main Switch** and disconnected from the power supply in the case of a instrument failure. The main fuses can then be inspected.

A suitable flat-head screwdriver must be used to prevent damage to the fuse holders.

Beware of defective fuses! Potential risk of injury due to broken glass! Wear suitable protective clothing (safety goggles, cut-resistant gloves (→ P. 18 – 3.1 Standard delivery – packing list)).

1. To do so, open the hood and unscrew the two fuse holders (→ Fig. 127-1) on the top of the right cover with a flat-head screwdriver
2. Check the fuse being used for damage.



Fig. 127

3. Remove the defective fuse from the holder and replace it with a new fuse.
4. Installation occurs in the reverse sequence of operations.

9. Optional Accessories and Consumables

9.1 Optional accessories

Designation	Order No.
Rack for 30 slides (3 pcs. per package)	14 0512 52473
Handle for rack for 30 slides (yellow, 3 pcs. per package)	14 0512 52476
Handle for rack for 30 slides (light blue, 3 pcs. per package)	14 0512 52477
Handle for rack for 30 slides (dark blue, 3 pcs. per package)	14 0512 52478
Handle for rack for 30 slides (pink, 3 pcs. per package)	14 0512 52479
Handle for rack for 30 slides (red, 3 pcs. per package)	14 0512 52480
Handle for rack for 30 slides (green, 3 pcs. per package)	14 0512 52481
Handle for rack for 30 slides (black, 3 pcs. per package)	14 0512 52482
Handle for rack for 30 slides (gray, 3 pcs. per package)	14 0512 52483
Handle for rack for 30 slides (white, 3 pcs. per package)	14 0512 52484
Rack adapter for Stainer ST5010/ST5020	14 0475 58558
Reagent vessel, assembly, each consisting of 1 pc.:	14 0512 47086
Reagent vessel	14 0512 47081
Reagent vessel cover	14 0512 47085
Reagent vessel handle	14 0512 47084
Label cover S	14 0512 53748
Label cover, blank	14 0512 47323
Waste tray	14 0514 49461
Needle cleaning container, kit (2 pcs.)	14 0514 54195
Prime bottle, assembly, consisting of:	14 0514 53931
Lab bottle, 150 ml	14 0514 56202
Screw cap	14 0478 39993
Prime bottle insert	14 0514 57251
28x3 mm O-ring	14 0253 39635
Cleaning bottle	14 0514 57248
Suction cup	14 3000 00403
Rack storage rails for the unload drawer	14 0514 56165
Active carbon filter set, consisting of:	14 0512 53772
Active carbon filter	14 0512 47131
Exhaust air hose set, consisting of:	14 0514 54815
Exhaust air hose, 2 m	14 0422 31974
Hose clamp	14 0422 31973
Cut-resistant gloves, size M, 1 pair	14 0340 29011
Tool kit HistoCore SPECTRA CV, consisting of:	14 0514 54189
Screwdriver, 5.5x150	14 0170 10702
Leica brush	14 0183 30751
T16A fuse	14 6000 04696



Fig. 128

Exhaust hose

1 set, consisting of the following:

- Exhaust hose of length: 2 m
- Hose clamp

Order No.:**14 0422 31974**

Fig. 129

Active carbon filter

1 set, consisting of 2 pcs.

Order No.:**14 0512 53772**

Fig. 130

Waste tray**Order No.:****14 0514 49461**



Fig. 131

Needle cleaning container

1 kit, consisting of 2 pcs.

Order No.:

14 0514 54195



Fig. 132

Reagent vessel

Assembly, incl. reagent vessel cover

Order No.:

14 0512 47086



Fig. 133

Racks

30 specimen slides (3 pcs. per package)

Order No.: 14 0512 52473

Fig. 134

Handle for racks

30 specimen slides (3 pcs. per package)

Color

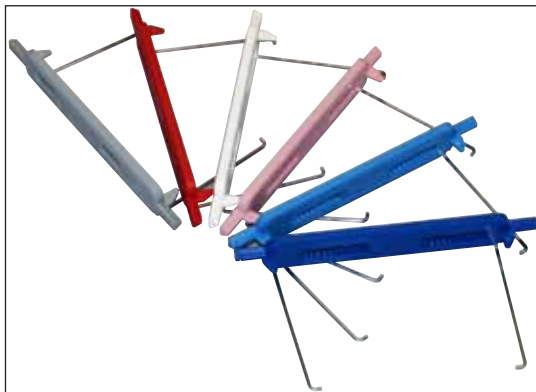
- yellow
- light blue
- dark blue
- pink
- red
- light green
- black
- gray
- white

Order No.:

14 0512 52476
 14 0512 52477
 14 0512 52478
 14 0512 52479
 14 0512 52480
 14 0512 52481
 14 0512 52482
 14 0512 52483
 14 0512 52484



Fig. 135

Prime bottle

Assembly, consisting of:

- Lab bottle, 150 ml
- Screw cap
- Prime bottle insert
- 28x3 mm O-ring

Order No.: 14 0514 53931



Fig. 136

Cleaning bottle

Assembly

Order No.:

14 0514 57248



Fig. 137

Suction cup

1 pcs.

Order No.:

14 3000 00403



Fig. 138

Storage rails for the unload drawer

1 set, consisting of 3 pcs.

Order No.:

14 0514 56165



Fig. 139

Cut-resistant gloves
1 pair, size M

Order No.: 14 0340 29011



Fig. 140

Tool kit HistoCore SPECTRA CV

Consisting of:

- Screwdriver, 5.5x150
- Leica brush
- T16A fuse

Order No.: 14 0514 54189



Fig. 141

Rack adapter for Stainer ST5010/ST5020

To be used to stain slides in SPECTRA racks in the ST5010 or ST5020

Order No.: 14 0475 58558

Consumables

Designation	Order No.
mounting medium	
HistoCore SPECTRA X1 (1 packaging unit, 2 bottles with 150 ml each)	380 1733
Coverglasses	
HistoCore SPECTRA CV premium coverglass 1x24x50 (8x300 pcs.)	380 0152

10. Warranty and Service

Warranty

Leica Biosystems Nussloch GmbH guarantees that the contractual product delivered has been subjected to a comprehensive quality control procedure based on the Leica in-house testing standards, and that the product is faultless and reflects all technical specifications and/or agreed characteristics.

The scope of the warranty is based on the content of the concluded agreement. The warranty terms of your Leica sales organization or the organization from which you have purchased the contractual product shall apply exclusively.

Yearly Preventive Maintenance

Leica recommends to conduct a yearly preventive maintenance. This has to be performed by a qualified Leica Service Representative.

Service information

If you are in need of technical customer support or spare parts, please contact your Leica representative or the Leica dealer where you purchased the instrument.

Please provide the following information on the instrument:

- Model name and serial number of the instrument.
- Location of the instrument and name of a contact person.
- Reason for the service call.
- The delivery date of the instrument. .

11 Decommissioning and Disposal

11. Decommissioning and Disposal



Warning

The instrument or parts of the instrument must be disposed of according to existing applicable, local regulations. All objects contaminated with spilled reagents must be disinfected immediately with a suitable disinfectant to prevent spreading to other areas of the lab or to lab personnel.

Please refer to the Chapter ([→ P. 106 – 7. Cleaning and Maintenance](#)) and the Chapter Decontamination Certificate ([→ P. 161 – 12. Decontamination Certificate](#)) at the end of these Instructions for Use for notes on cleaning the HistoCore SPECTRA CV coverslipper.

To reduce potential contamination, thorough disinfecting of the instrument is required before re-commissioning or disposal (e.g. multiple cleaning steps, disinfection or sterilization). Dispose of the instrument in compliance with the applicable laboratory specifications.

Contact your Leica representative for more information.

12. Decontamination Certificate

Any product that is to be returned to Leica Biosystems or serviced on site must be properly cleaned and decontaminated. Please find the dedicated template for confirming decontamination by using the search function on our website at www.LeicaBiosystems.com. This template must be used to enter all required data.

If a product is returned, a copy of the completed and signed decontamination certificate must either be enclosed or handed over to a service technician. The user shall be responsible for products that are returned without a completed decontamination certificate or with a missing decontamination certificate. Return shipments that are classified by the company as a potential hazard source will be returned to the sender at his/her own expense and risk.

www.LeicaBiosystems.com



Leica Biosystems Nussloch GmbH
Heidelberger Strasse 17 - 19
69226 Nussloch
Germany

Tel.: +49 - (0) 6224 - 143 0
Fax: +49 - (0) 6224 - 143 268
Web: www.LeicaBiosystems.com