

# HistoCore MULTICUT

## Rotary Microtome

Instructions for Use

English

**Order No.: 14 0518 80101 - Revision M**

Always keep this manual with the instrument.

Read carefully before working with the instrument.





The information, numerical data, notes and value judgments contained in this manual represent the current state of scientific knowledge and state-of-the-art technology as we understand it following thorough investigation in this field.

We are under no obligation to update the present manual periodically and on an ongoing basis according to the latest technical developments, nor to provide our customers with additional copies, updates etc. of this manual.

To the extent permitted in accordance with the national legal system as applicable in each individual case, we shall not be held liable for erroneous statements, drawings, technical illustrations etc. contained in this manual. In particular, no liability whatsoever is accepted for any financial loss or consequential damage caused by or related to compliance with statements or other information in this manual.

Statements, drawings, illustrations and other information regarding the contents or technical details of the present Instructions for Use are not to be considered warranted characteristics of our products.

These are determined only by the contract provisions agreed between ourselves and our customers. Leica reserves the right to change technical specifications as well as manufacturing processes without prior notice. Only in this way is it possible to continuously improve the technology and manufacturing techniques used in our products.

This document is protected under copyright laws. All copyrights to this documentation are held by Leica Biosystems Nussloch GmbH.

Any reproduction of text and illustrations (or of any parts thereof) by means of print, photocopy, microfiche, web cam or other methods – including any electronic systems and media – requires express prior permission in writing by Leica Biosystems Nussloch GmbH.

For the instrument serial number and year of manufacture, please refer to the nameplate on the back of the instrument.



Leica Biosystems Nussloch GmbH  
Heidelberger Strasse 17 - 19  
D-69226 Nussloch  
Germany

Tel.: +49 - (0) 6224 - 143 0  
Fax: +49 - (0) 6224 - 143 268  
Web: [www.LeicaBiosystems.com](http://www.LeicaBiosystems.com)

Assembly contracted to Leica Microsystems Ltd. Shanghai

# Table of Contents

---

<b>1.</b>	<b>Important Information .....</b>	<b>7</b>
1.1	Symbols used in the text and their meanings.....	7
1.2	Instrument type.....	9
1.3	Intended purpose.....	9
1.4	Qualification of personnel.....	9
<b>2.</b>	<b>Safety .....</b>	<b>11</b>
2.1	Safety notes.....	11
2.2	Warnings.....	11
2.2.1	Markings on the instrument itself .....	12
2.2.2	Transport and installation .....	12
2.2.3	Operating the instrument.....	14
2.2.4	Cleaning and maintenance .....	21
2.3	Integrated protective devices .....	22
2.3.1	Locking the handwheel.....	23
2.3.2	Safety guard on the knife/blade holder.....	24
<b>3.</b>	<b>Instrument Components and Specifications.....</b>	<b>25</b>
3.1	Overview — instrument components .....	25
3.2	Instrument specifications.....	26
3.3	Technical Data .....	27
<b>4.</b>	<b>Setting up the instrument .....</b>	<b>30</b>
4.1	Installation site requirements.....	30
4.2	Standard delivery - packing list.....	30
4.3	Unpacking and installation.....	32
4.4	Assembling the handwheel.....	35
4.5	Electrical connections .....	36
4.5.1	Checking the voltage.....	36
4.5.2	Connecting the power supply.....	36
4.5.3	Connecting the control panel .....	37
4.6	Switching on the instrument.....	37
<b>5.</b>	<b>Operation.....</b>	<b>39</b>
5.1	Operating elements and their functions .....	39
5.1.1	Instrument control panel.....	39
5.1.2	Separate control panel.....	40
5.1.3	Display and control elements.....	41
5.1.4	Electronic coarse feed wheel.....	47
5.1.5	Fine directional specimen holder fixture .....	48
5.1.6	Fine adjustment of the force balance.....	49
5.2	Inserting the two-in-one blade holder E.....	50

---

5.2.1	Setting up the blade holder base .....	50
5.2.2	Inserting the two-in-one blade holder E .....	51
5.3	Adjusting the clearance angle .....	51
5.4	Inserting the universal cassette clamp.....	52
5.5	Clamping the specimen .....	53
5.6	Clamping the knife/disposable blade .....	53
5.7	Trimming the specimen .....	56
5.8	Sectioning .....	57
5.9	Changing the specimen or interrupting sectioning .....	59
5.10	Finishing the daily routine .....	60
<b>6.</b>	<b>Optional Accessories.....</b>	<b>62</b>
6.1	Assembly for fixture for specimen clamps.....	62
6.1.1	Rigid fixture for specimen clamps .....	62
6.1.2	Directional fixture for specimen clamps.....	63
6.1.3	Fine-directional fixture for specimen clamps.....	63
6.1.4	Quick clamping system.....	64
6.2	Specimen clamps and holders.....	64
6.2.1	Standard specimen clamp .....	65
6.2.2	Universal cassette clamp.....	65
6.2.3	Super cassette clamp .....	67
6.3	Knife holder base and knife holder.....	68
6.3.1	Two-in-one blade holder E.....	68
6.3.2	Knife holder base, without lateral displacement feature .....	70
6.3.3	Knife holder E with a water trough for low-profile blades .....	70
6.3.4	Knife holder N.....	71
6.4	Section waste tray.....	73
6.5	Backlighting.....	73
6.6	Top tray.....	74
6.7	Universal microscope carrier.....	74
6.8	Magnifying lens, LED illumination.....	77
6.9	Additional accessories .....	79
6.10	Ordering information .....	89
<b>7.</b>	<b>Troubleshooting .....</b>	<b>91</b>
7.1	Error codes .....	91
7.2	Possible faults .....	92
7.3	Instrument malfunctions.....	94
7.4	Malfunctions of the two-in-one blade holder E.....	96
7.4.1	Replacing the pressure plate.....	96
7.4.2	Mounting the clamping top onto the segment arc.....	97

## Table of Contents

---

7.5	The setting of the clamping system of the clamp mount .....	97
<b>8.</b>	<b>Cleaning and Maintenance.....</b>	<b>98</b>
8.1	Cleaning the instrument.....	98
8.2	Maintenance .....	101
8.2.1	Replacing fuses.....	101
8.3	Maintenance instructions .....	102
8.4	Lubricating the instrument.....	103
<b>9.</b>	<b>Warranty and Service .....</b>	<b>105</b>
9.1	Warranty .....	105
9.2	Service information .....	105
9.3	Decommissioning and disposal.....	105
<b>10.</b>	<b>Decontamination Confirmation .....</b>	<b>107</b>

## 1. Important Information

### 1.1 Symbols used in the text and their meanings



Danger:

Indicates an imminently hazardous situation which, if not avoided, will result in death or serious injury.



Warning:

If this danger is not avoided, then this may result in death or serious injury.



Caution:

Indicates a potentially hazardous situation which, if not avoided, could result in death or serious injury.



Note:

Indicates a situation with the potential for property damage which, if not avoided, could result in damage to the machine or something in its vicinity.



Tip:

Gives you tips to simplify your workflow.

1

→ "Fig. 7 - 1"

Item numbers for numbering illustrations.

Numbers in red refer to item numbers in illustrations.

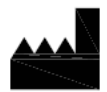

Manufacturer



Order number

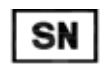

Serial number



Date of manufacture



Observe the Instructions for Use.



Caution, consult the instructions for use for cautionary information.



In vitro diagnostics (IVD) medical device



The CE marking is the manufacturer's declaration that the medical product meets the requirements of the applicable EC directives and regulations.



The Country of Origin box defines the Country where the final character transformation of the product has been performed.



The UKCA (UK Conformity Assessed) marking is a new UK product marking that is used for goods being placed on the market in Great Britain (England, Wales and Scotland). It covers most goods which previously required the CE marking.

UKRP

Leica Microsystems (UK) Limited  
Larch House, Woodlands Business Park, Milton Keynes,  
England, United Kingdom, MK14 6FG

The UK Responsible Person acts on behalf of the non-UK manufacturer to carry out specified tasks in relation to the manufacturer's obligations.



Symbol for labeling electrical and electronic equipment in accordance with Section 7 of the German Electrical and Electronic Equipment Act (ElektroG). ElektroG is the law on the bringing into circulation, return and environmentally compatible disposal of electrical and electronic equipment.



The CSA test mark means that a product has been tested and fulfills the applicable safety and/or performance standards, including the relevant standards defined or administered by the American National Standards Institute (ANSI), Underwriters Laboratories (UL), the Canadian Standards Association (CSA), the National Sanitation Foundation International (NSF) and others.



Symbol for alternating current



PE terminal



Power on



Power off



The package contents are fragile and must be handled with care.



The package must be kept in a dry environment.

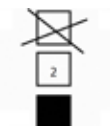

Maximum of 3 stacked layers



Indicates the correct upright position of the package.

Transport temperature range:

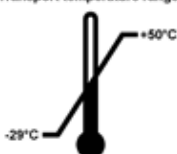

Indicates the temperature range permitted for transporting the package.  
Minimum -29 °C  
Maximum +50 °C



Storage temperature range:



Indicates the temperature range permitted for storing the package.  
Minimum +5 °C  
Maximum +50 °C



Indicates the humidity range permitted for storing and transporting the package.  
minimum 10 % r.H.  
maximum 85 % r.H



In the Shockwatch system, the shock dot shows impacts or shocks that are above a specified intensity through red colouration. Exceeding a defined acceleration (g value) causes the indicator tube to change colour.



Indicates the item can be recycled where correct facilities exist.

## 1.2 Instrument type

All information provided in these Instructions for Use applies only to the instrument type indicated on the title page. A nameplate indicating the instrument serial number is attached at the back side of the instrument.

## 1.3 Intended purpose

The HistoCore MULTICUT is a semi-motorized (motorized specimen feeding), manually operated rotary microtome specifically designed for creating thin sections of formalin fixed, paraffin embedded human tissue specimens of varying hardness used for histological medical diagnosis by a pathologist, e.g. for cancer diagnosis. It is intended for sectioning soft and hard human specimens, as long as they are suitable for being cut manually. The HistoCore MULTICUT is designed for in vitro diagnostic applications.



### Warning

Any use other than the intended use.

**Serious injury of persons and/or damage to specimen.**

- Follow the intended use described in the Instructions for Use. Any other use of the instrument will be considered as improper use.

## 1.4 Qualification of personnel

- The HistoCore MULTICUT must be operated by trained laboratory personnel only. The instrument is intended for professional use only.

- All laboratory personnel designated to operate this instrument must read these Instructions for Use carefully and must be familiar with all technical features of the instrument before attempting to operate it.

## 2. Safety

### 2.1 Safety notes

The Instructions for Use include important information related to the operating safety and maintenance of the instrument.

The Instructions for Use are an important part of the product, and must be read carefully prior to startup and use and must always be kept near the instrument.

This instrument has been built and tested in accordance with the safety regulations for electrical measuring, control, regulating and laboratory instruments.

To maintain this condition and ensure safe operation, the user must observe all notes and warnings contained in the Instructions for Use.

The safety and caution notes in this chapter must be observed at all times.

Be sure to read these notes even if you are already familiar with the operation and use of other Leica Biosystems products.

The Instructions for Use must be appropriately supplemented as required by the existing regulations on accident prevention and environmental safety in the operator's country.



#### Warning

Protective devices or safety accessories provided by manufacturer have been removed or modified.

**Serious injury of persons and/or property damage including specimen damage.**

- Never remove or modify any protective devices of the instrument or any accessories. Only service personnel qualified by Leica Biosystems may repair the instrument and access the instrument's internal components.
- Before working with the instrument always assure that all protective devices and safety accessories are in place and fulfill their purpose properly.



#### Tip

For current information about applicable standards, please refer to the CE Declaration of Conformity and UKCA Certificates on our Internet site:

<http://www.LeicaBiosystems.com>

The electromagnetic environment should be evaluated prior to operation of the instrument. Do not use this instrument in close proximity to sources of strong electromagnetic radiation (e.g. unshielded intentional RF sources), as these can interfere with the proper operation.

The instrument complies with the emission and immunity requirements described in the IEC 61326-2-6.

### 2.2 Warnings

The protective devices installed in this instrument by the manufacturer only constitute the basis for accident prevention. Operating the instrument safely is, above all, the responsibility of the owner, as well as the designated personnel who operate, service or clean the instrument.

To ensure trouble-free operation of the instrument, be sure to comply with the following instructions and warnings.

### 2.2.1 Markings on the instrument itself



#### Warning

Failure to follow the correct operating instructions (as defined in the Instructions for Use) of the corresponding markings and warning triangles on the instrument.

#### **Serious injury of persons and/or damage to instrument, accessories or specimen.**

- Pay attention to the markings on the instrument and strictly follow operating instructions described in the Instructions for Use when operating or replacing the item marked.

### 2.2.2 Transport and installation



#### Warning

Accessories/instrument falling out of the package during unpacking.

#### **Serious injury of persons and/or property damage.**

- Be careful when unpacking the instrument.
- Once unpacked, the instrument must be moved only in an upright position.
- Thoroughly follow the instructions given in the Unpacking Instructions attached at the outside of the package or the actions described in the Instructions for Use.



#### Warning

Instrument is lifted inappropriately.

#### **Serious injury of persons and/or property damage.**

- When lifting the instrument touch it only at the lifting points described in the Instructions for Use and Unpacking Instructions (base plate at the front and under the instrument on the back).
- Never lift the instrument by the handwheel grip, electric coarse feed wheel, or object head.
- Always remove the section waste tray before transporting the instrument.



#### Warning

Careless moving of the instrument.

#### **Serious injury of hands and/or fingers due to getting crushed between instrument and working surface.**

- When moving the instrument, touch it only at the lifting points described in the Instructions for Use and Unpacking Instructions (base plate at the front and under the instrument on the back).
- Thoroughly pay attention that hands do not get between instrument and working surface.



#### Warning

Instrument not positioned safely with all 4 feet on an appropriate laboratory table.

#### **Serious injury of persons and/or property damage.**

- Put the instrument only on a stable, vibration free laboratory table with horizontal, flat table top. Ground needs to be vibration-free as far as possible.
- Always make sure that all 4 feet are positioned completely on the laboratory table.
- If the instrument has been potentially moved by other persons (for example for servicing) always double-check correct positioning.

**Warning**

Condensation inside the instrument due to exposure to extreme differences in temperature and high air humidity.

**Damage of the instrument.**

- Always make sure that for both storage and operation appropriate climate conditions are met. See the section of Technical data (→ P. 27 – 3.3 Technical Data).
- After transporting the instrument, wait at least two hours to allow the instrument to adopt the ambient temperature before turning it on.

**Warning**

Knife/blade holder falling off the instrument.

**Serious injury of persons and/or property damage.**

- If the knife/blade holder is not fixed, for example, during installation or cleaning, pay special attention that the knife/blade holder is not falling off.
- Whenever possible, fix the knife/blade holder to avoid falling off.
- For installation or maintenance purposes remove the knife/blade holder from the knife holder base to avoid accidental falling off.

**Warning**

Section waste tray falling down after it has been detached.

**Injury of persons.**

- Work especially carefully when detaching the section waste tray and put it in a safe place.

**Warning**

Oil is spilled and not cleaned-up immediately.

**Serious injury of persons, for example, by slipping and getting in contact with dangerous parts like the knife/blade of the instrument.**

- Always make sure that no oil is spilled.
- If oil has been spilled, clean it up immediately, thoroughly and completely.

**Warning**

Paraffin waste falls on the floor and is not cleaned-up.

**Serious injury of persons, for example, by slipping and stumbling into the knife/blade.**

- Always clean up paraffin waste before it spreads, becomes slippery, and becomes a hazard.
- Wear appropriate shoes.

**Warning**

Wrong voltage of power supply selected at the voltage selector.

**Instrument damage, delay of specimen processing.**

- Assure to select the voltage fitting to your mains voltage before plugging in the instrument.
- When changing the voltage selector setting, the instrument must be disconnected from the mains.

## 2 Safety



### Warning

Connecting the instrument to a non-grounded socket, or use an extension cord.

**Risk of electrical shock which causes injury to persons, or delayed diagnosis.**

- The instrument must be connected to a grounded socket.
- Do not use an extension cord.



### Caution

Accessories/components loosening/damaged during transportation.

**Property damage or delayed diagnosis.**

- The packaging has the ShockDot Impact Indicator, that indicates improper transport. When the instrument is delivered, check this first. If the indicator is triggered, the package was not handled as prescribed. In this case, please mark the shipping documents accordingly and check the shipment for damage.

### 2.2.3 Operating the instrument



### Danger

Explosive hazard.

**Death or serious injury of persons, and/or property damage.**

- Never operate the instrument in rooms with an explosive hazard.



### Warning

Personnel with insufficient qualification working with the instrument.

**Serious injury of persons and/or specimen damage can occur when specimen approaches knife/blade due to inappropriate operator actions, for example, because object head may drop onto knife holder when handwheel is unlocked.**

- Always make sure that only laboratory personnel with dedicated and sufficient training and qualification operates the instrument.
- Always make sure that all laboratory personnel designated to operate this instrument has read these Instructions for Use carefully and is familiar with all technical features of the instrument before start working with it.



### Warning

Protective devices or safety accessories provided by manufacturer have been removed or modified.

**Serious injury of persons and/or property damage including specimen damage.**

- Never remove or modify any protective devices of the instrument or any accessories. Only service personnel qualified by Leica Biosystems may repair the instrument and access the instrument's internal components.
- Before working with the instrument always assure that all protective devices and safety accessories are in place and fulfill their purpose properly.

**Warning**

Personal protective equipment is not used.

**Injury of persons.**

- When working with microtomes, personal safety precautions must always be taken. It is mandatory to wear work safety shoes, safety gloves, a mask and safety goggles.

**Warning**

Knives or blades are handled and/or disposed in an inappropriate manner.

**Serious injury of persons due to contact with extremely sharp knife/blade.**

- Work especially thoroughly and carefully when handling the knife/blade.
- Always wear dedicated clothes (including cut-resistant gloves) when handling knife/blade.
- Dispose knives and blades always in a safe place (for example, dedicated knife case) and an appropriate manner that ensures that people cannot get hurt.
- Never place a knife anywhere with the cutting edge facing upwards and never try to catch a falling knife.
- Always cover the edge of the knife/blade with the safety guard before clamping the specimen.

**Warning**

Knife/Blade was not removed when knife/blade holder was uninstalled from the microtome.

**Serious injury of persons due to contact with extremely sharp knife/blade.**

- Before uninstalling the knife/blade holder from the microtome always make sure to detach the knife/blade wearing cut-resistant gloves and store the knife/blade in a safe place.

**Warning**

The operator grabs into the knife/blade due to inappropriate working procedure.

**Serious injury of persons when putting the specimen in place if knife/blade has been installed before.**

- Prior to uploading the specimen on the microtome, make sure that the cutting edge has been covered by the safety guard and the hand wheel locking mechanism has been activated. Once the operator wants to upload the specimen as well as inserting a knife/blade, always upload the specimen block before mounting and clamping the knife/blade.

**Warning**

The operator installs two knives/blades on the knife/blade holder.

**Serious injury of persons due to contact with extremely sharp knives and/or blades.**

- Do not clamp two knives/blades on the knife holder/blade holder. Install the knife/blade in the center of the knife/blade holder. Knives/blades must not exceed the edge of the knife/blade holder.

## 2 Safety



### Warning

Too thick or thin blade used in the two-in-one blade holder.

#### Sample impaired.

- Use a blade with a maximum thickness of less than 0.322mm and a minimum thickness of more than 0.246mm.
- The recommended compatible blade is listed in Optional Accessories (→ P. 62 – 6. Optional Accessories).



### Warning

The blade is not installed completely parallel to the upper edge of the pressure plate due to excess paraffin, uncleaned inserts, etc..

**When using the lateral movement function, failure to install the blade parallel to the pressure plate may result in poor sectioning results. For example, if a section is too thick or thin, chattering within the section, in the worst-case scenario, may damage the specimen.**

- Do not continue the sectioning when getting unsatisfying section results.
- Re-install the blade and make sure that it is parallel to the upper edge of the pressure plate.
- Always check the parallelism between the blade and pressure plate after moving the blade using the lateral movement function.
- Ensure there is no paraffin waste and the insert is clean before use.



### Warning

The knife/blade is installed before the knife/blade holder and the knife/blade holder base are installed on the instrument.

#### Serious injury of persons due to contact with extremely sharp knives and/or blades.

- Prior to inserting the knife/blade, both the knife/blade holder and the knife/blade holder base must be installed on the microtome.



### Warning

Knife/blade is not covered with the appropriate guard when not sectioning specimen.

#### Serious injury of persons.

- Always cover the knife/blade edge with the appropriate guard prior to any manipulation of knife/blade or specimen clamp, prior to changing the specimen and during all work breaks.



### Warning

Knife/blade stored in inappropriate manner.

#### Serious injury of persons, for example due to unexpected fall off.

- Always store the knife/blade in an appropriate place when not using it, for example, store it in the dedicated knife case.
- Never place a knife anywhere with the cutting edge facing upwards and never try to catch a falling knife.



**Warning**

Uploading or unloading the specimen on the microtome without appropriate clothes and in an inappropriate manner.

**Operator can get cut and injured which can lead to serious consequences.**

- Always use cut resistant safety gloves when handling the specimen within the microtome.
- Lock the handwheel and cover the knife edge with the safety guard prior to any manipulation of the specimen clamp and prior to changing the specimen.

**Warning**

Specimen is oriented in retraction phase.

**Specimen damage due to re-orienting the specimen in retraction phase.**

- Specimen blocks must not be oriented during the retraction phase. If a block is oriented during retraction, the block will advance by the retraction value plus the selected section thickness before the next section. This may cause damage to both specimen and knife/blade.

**Warning**

Working with the instrument and brittle specimen without appropriate protective clothes.

**Serious injury of persons by splinters while cutting brittle specimen.**

- Always wear appropriate protective clothes (including safety goggles) and work especially carefully when cutting brittle specimen.

**Warning**

Wrong fine adjustment of the force balance.

**Serious injury of the operator due to contact with knife and/or specimen damage.**

- Before working with the instrument, always double-check that the fine adjustment of the force balance is properly set.
- If fine adjustment is not properly set, do not work with the instrument but perform a readjustment. For details, refer to chapter "Fine adjustment of the force balance".
- Especially after changing accessories at the object head, perform a fine adjustment of the force balance immediately.

**Warning**

Insufficient frame conditions for sectioning.

**Specimen damage or poor sectioning results, for example, sections alternating in thickness, compressed, folded or stripped sections.**

- Do not continue sectioning if you recognize insufficient sections results.
- Make sure that all prerequisites for appropriate sectioning are met. Refer to the troubleshooting section of these Instructions for Use for further details.
- If you do not have sufficient knowledge in regards of troubleshooting insufficient sectioning results consult persons who do have that knowledge, for example, application experts of Leica Biosystems.

## 2 Safety



### Warning

Wheel turn direction of electric coarse feed incorrectly selected.

#### **Specimen damage.**

- Always assure that you have selected the correct turn direction of the coarse feed before turning the wheel.



### Warning

Turning the handwheel counterclockwise.

#### **People injury/Damage to specimen.**

- Do not turn the handwheel counterclockwise, which may lead to handwheel locking mechanism malfunction.



### Warning

The handwheel is unlocked and the object head drops into knife/blade holder.

#### **People injury/Damage to specimen.**

- Except sectioning phase, the handwheel must be locked at all times.



### Warning

The rotation speed of the handwheel does not suit the hardness of the specimen.

#### **Instrument damage and possibly specimen damage.**

- The rotation speed of the handwheel must be adapted to suit the hardness of the specimen. For harder specimens, use a slower speed.



### Warning

In the manual sectioning mode, the user cuts the specimen block by rotating the handwheel at a very high speed.

#### **It may lead to poor sectioning quality and even damage the specimen.**

- In the manual sectioning mode, the rotation speed of the handwheel shall be no more than 60 rpm.



### Warning

The handwheel brake lever is not used properly, and the handwheel cannot be braked.

#### **Serious injury of instrument/persons, or specimen damage.**

- The handwheel brake lever must be exactly in the locked position. If the handwheel brake lever is moved beyond this point, it is possible that the handwheel is no longer braked.



### Warning

When doing fast manual trimming and fingers are put between the specimen and the knife/blade after the handwheel is released.

#### **Operator can get cut and injured due to the turning of the handwheel when it is unlocked.**

- Do not put fingers between the specimen and the knife/blade during trimming and sectioning.

**Warning**

Improper fix to software freeze.

**Specimen damage and/or delay of diagnose.**

- In case of a software freeze follow the instructions given in chapters Troubleshooting and Operation.
- If instrument cannot set back into operation immediately, make sure that the specimen is stored in an appropriate manner to avoid any damage to it.
- If required, contact Leica Biosystems service representative.

**Caution**

After the knife/blade holder is laterally displaced, the specimen is not retracted and retrimmed.

**Specimen damage.**

- Retract the object head and retrim the specimen block each time after laterally displacing the knife/blade holder.

**Caution**

Rotating the handwheel and the coarse feed wheel at the same time.

**Specimen damage.**

- Do not turn the coarse feed wheel whilst rotating the handwheel.

**Caution**

The feather key is lost when mounting the handwheel.

**The instrument cannot be used, and it may cause the delay of diagnosis.**

- Before assembling the handwheel, check the feather key and make sure that it is in the handwheel shaft.

**Caution**

Manual movement of knife/blade holder and/or object head after setting-up the memory position.

**Damage of specimen.**

- Do not move the knife/blade holder, the holder base and/or object head and do not readjust the orientation without readjusting the memory position.

**Caution**

After trimming by using the electronic coarse feed, the user does not switch to sectioning mode.

**Specimen damage or unexpected functioning of the instrument.**

- After completion of trimming with the electronic coarse feed remember to switch back to sectioning mode.
- Before starting sectioning always make sure that an appropriate sectioning thickness has been selected.

## 2 Safety



### Caution

Turning the electronic coarse feed wheel during fast homing or moving to the memory position.

#### **Specimen impaired.**

- Do not touch the electronic coarse feed wheel during fast homing or moving to the memory position.



### Caution

Turning the handwheel or pressing buttons on the separate control panel or the instrument control panel during fast homing or moving to the memory position.

#### **Specimen impaired.**

- Do not turn the handwheel or press any button on the separate control panel or the instrument control panel during fast homing or moving to the memory position.



### Caution

The memory position is set too close to the knife/blade.

#### **Specimen impaired.**

- Make sure that the specimen does not touch the cutting edge of the knife/blade when setting the memory position. Move the object head a little bit backward if the cutting edge touches the specimen or is positioned very close to the surface of the specimen when setting the memory position.
- Do not upload a specimen with different thickness using the same memory position.



### Caution

Failure to reset the memory position after the instrument is switched off or after a power failure.

#### **Damage to specimen.**

- When the instrument is switched off or there is a power failure, previously stored memory position data is erased. Set the memory position again after powering on the instrument.



### Note

Accessories and components experience corrosion due to using corrosive/strongly acidic/alkaline reagent or solvent with the instrument or accessories, such as decalcified solution that contains acid, ammonium hydroxide that contains alkali, etc.

#### **Accessories can malfunction.**

- Avoid corrosive/strongly acidic/alkaline reagent or solvent dripping onto the instrument surface or accessories.
- If such reagent or solvent has dripped onto the instrument surface or accessories, wipe off the residue and dry the accessories sufficiently as soon as possible.
- If such reagent or solvent is used frequently, carry out a thorough daily cleaning of the blade holder, the universal cassette clamp (UCC), and other accessories if necessary.

## 2.2.4 Cleaning and maintenance



### Warning

Cleaning the instrument without unplugging the power plug.

#### **Electrical shock which causes injury of persons.**

- Before each cleaning, switch off the instrument and disconnect the power plug from the mains.



### Warning

The liquids go into the interior of the instrument.

#### **Serious injury of instrument/persons.**

- Ensure that liquids do not enter the interior of the instrument during operation and maintenance. Spray proper solvents or cleaners on a cleaning pad and not directly on the instrument to prevent liquids from entering. If liquids go into interior of instrument, contact Leica Biosystems service.



### Warning

Wiping the knife in the wrong direction during cleaning.

#### **Serious injury of persons.**

- Always wipe the knife from the back of the knife to the cutting edge.



### Warning

Removing the parts from the drying chamber (65 °C) during cleaning of the knife/blade holder.

#### **Scalding hazard.**

- Wear heat insulating gloves when removing the parts from the drying chamber (65 °C).



### Warning

Replacing the fuses without switching off the instrument and unplugging the power plug.

#### **Electrical shock which causes injury of persons.**

- Turn the instrument off with the power switch and disconnect the power plug from the mains before replacing the fuses.



### Caution

Using the wrong fuses which are not with the same specification defined in the section of Technical data in the Instructions for Use.

#### **Delayed diagnosis because the instrument does not work using wrong fuses.**

- Only use fuses of the same specification defined in the section of Technical data in the Instructions for Use.

## 2 Safety

---



### Caution

Use of improper solvents or cleaners, or sharp/hard tools to clean the instrument or accessories.

#### **Potential instrument malfunction or delay of diagnosis.**

- Do not use any solvents containing acetone or xylene for cleaning the instrument.
- When using cleaners, please comply with the safety instructions of the manufacturer and the laboratory safety regulations.
- Never use a sharp or hard tool to scrape the instrument surface.
- Never soak the accessories in any cleaning solvent or water.
- Clean steel knives using an alcohol-based solution or acetone.
- For cleaning and removal of paraffin, do not use xylene or cleaning fluids containing alcohol (for example glass cleaner).



### Caution

During cleaning, the parts of blade holders are mixed up.

#### **Poor section quality.**

- Do not mix up blade holders during cleaning.

### 2.3 Integrated protective devices



### Warning

Protective devices or safety accessories provided by manufacturer have been removed or modified.

#### **Serious injury of persons and/or property damage including specimen damage.**

- Never remove or modify any protective devices of the instrument or any accessories. Only service personnel qualified by Leica Biosystems may repair the instrument and access the instrument's internal components.
- Before working with the instrument always assure that all protective devices and safety accessories are in place and fulfill their purpose properly.

### 2.3.1 Locking the handwheel

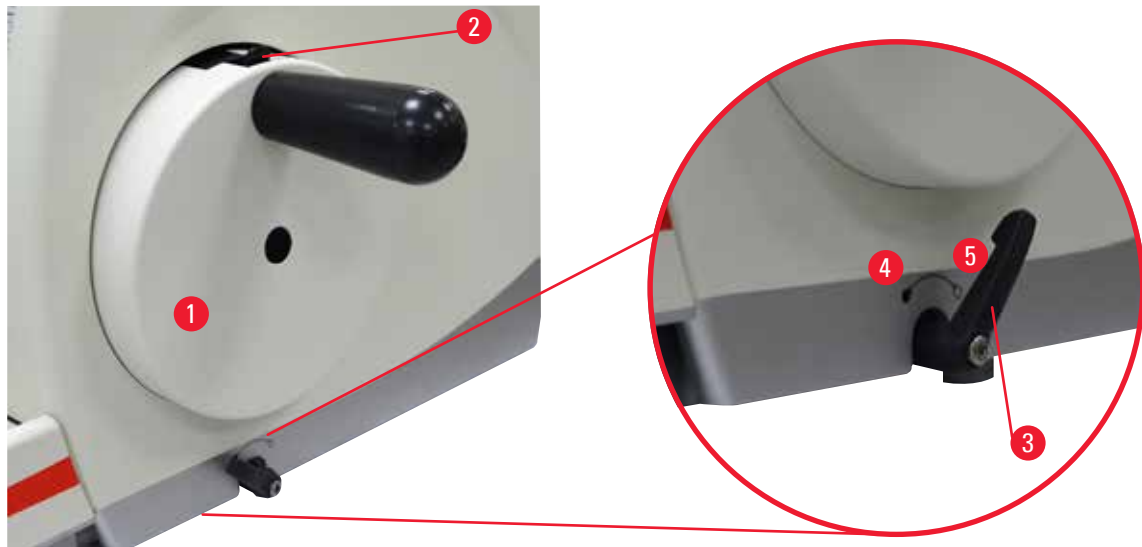

Fig. 1

There are two ways of locking the handwheel (→ "Fig. 1-1"):

- Using the handwheel brake lever (→ "Fig. 1-3") on the right side of the microtome base plate, the handwheel can be braked in any position.
  1. To brake, rotate the handwheel brake lever in a counterclockwise direction to position (→ "Fig. 1-4").
- Using the handwheel locking mechanism (→ "Fig. 1-2") on the top of the handwheel, the handwheel can be braked in the 12 o'clock position.
  1. To lock the handwheel, press the handwheel locking mechanism (→ "Fig. 1-2") outwards and continue to turn clockwise the handwheel slowly until it locks exactly in the 12 o'clock position.
  2. To unlock the handwheel, turn the handwheel locking mechanism (→ "Fig. 1-2") inwards.



#### Warning

The handwheel brake lever is not used properly, and the handwheel cannot be braked.

**Serious injury of instrument/persons, or specimen damage.**

- The handwheel brake lever must be exactly in the locked position. If the handwheel brake lever is moved beyond this point, it is possible that the handwheel is no longer braked.

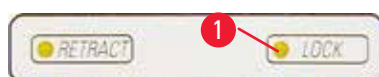

Fig. 2

In both cases (the handwheel brake lever and handwheel locking mechanism), the yellow LED (→ "Fig. 2-1") in the **LOCK** will be lit.



#### Tip

When using both brake systems at the same time, always move the handwheel brake lever (→ "Fig. 1-3") to position (→ "Fig. 1-5") first. Otherwise, it may not be possible to release the handwheel locking mechanism (→ "Fig. 1-2").

### 2.3.2 Safety guard on the knife/blade holder

Each knife holder is equipped with a tightly mounted safety guard (→ "Fig. 3-1") (→ "Fig. 4-1"). This makes it possible to cover completely the cutting edge in every knife or blade position.

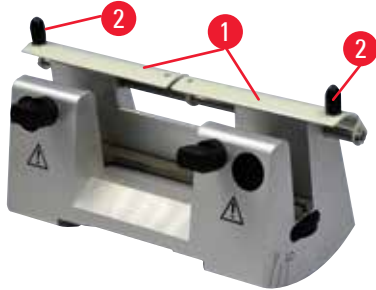

Fig. 3

#### Knife holder N

The safety guard (→ "Fig. 3-1") of the knife holder N can be easily positioned via two handles (→ "Fig. 3-2"). To cover the knife edge, push both cover strips of the safety guard to the center.

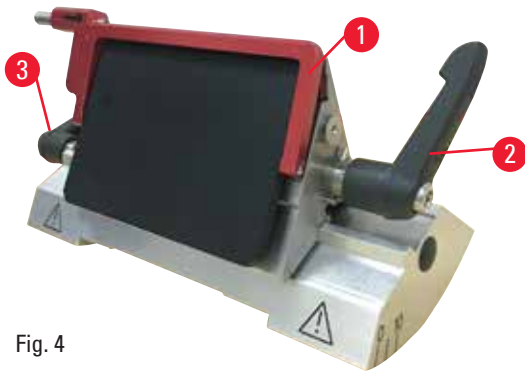

Fig. 4

#### Two-in-one blade holder E for high and low profile blades

The safety guard on the two-in-one blade holder E consists of a red foldaway handle (→ "Fig. 4-1"). To cover the cutting edge, fold the safety guard handle upwards as illustrated in (→ "Fig. 4").



#### Tip

The clamping levers on the two-in-one blade holder E are not interchangeable. The two clamping levers (→ "Fig. 4-2") (→ "Fig. 4-3") must remain in the position shown at all times, as otherwise isolated malfunctions of the two-in-one blade holder E can occur. The clamping lever for the blade (→ "Fig. 4-2") is at the right side, the clamping lever for the lateral displacement (→ "Fig. 4-3") is at left side.



### 3. Instrument Components and Specifications

#### 3.1 Overview — instrument components



Fig. 5

- |   |   |    |                                      |
|---|---|----|--------------------------------------|
| 1 | Top tray                                      | 8  | Anti-static waste tray               |
| 2 | Coarse feed wheel                             | 9  | Handwheel brake lever                |
| 3 | Separate control panel                        | 10 | Object head with orientation and UCC |
| 4 | Microtome base                                | 11 | Handwheel                            |
| 5 | Blade holder base                             | 12 | Handwheel locking mechanism          |
| 6 | Two-in-one blade holder E                     | 13 | Instrument control panel             |
| 7 | Clamping lever of the knife/blade holder base |    |                                      |

## Rear view

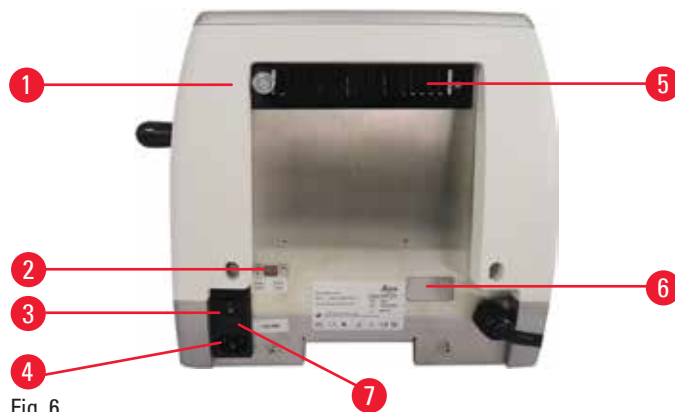

Fig. 6

- |   |                  |   |                        |
|---|------------------|---|------------------------|
| 1 | Magnet           | 5 | Vents                  |
| 2 | Voltage selector | 6 | Connection for service |
| 3 | Main switch      | 7 | Fuse housing and fuses |
| 4 | Power supply     |   |                        |

## 3.2 Instrument specifications

Basic instrument with separate control panel, programmable retraction with ON/OFF selection, ergonomically positioned electrical coarse feed wheel with user selectable turn directions, without specimen orientation or additional accessories. 100/120/230/240V AC, 50/60Hz.

- Semi-Motorized Rotary Microtome with low-maintenance and backlash-free precision micrometer feed system with step motor.
- Horizontal feed and vertical stroke mechanisms are based on cross roller bearings.
- Smooth-running hand-wheel allows two manual sectioning modes: rocking mode and conventional manual sectioning with full hand-wheel rotation.
- Two independent hand-wheel locking systems.
- Operator-adjustable force balancing system with spring force compensation offers two advantages:
  1. Flexibility to adapt the spring force to different weights of specimen/clamps, minimizing the risk of an object head dropping into the knife.
  2. No need for a heavy counter balance in the hand-wheel.
- All important controls are located on the user friendly separate control panel with adjustable inclination angle for ergonomic operation.
- Section thickness settings for trimming and sectioning can be selected and saved independently of each other.
- Important operating information is indicated on the front of the instrument:
  1. trimming or section thickness,
  2. specimen retraction (Retract),
  3. hand-wheel/specimen head locking function (Lock),
  4. section counter and section thickness totalizer with reset function.
- Programmable specimen retraction system with ON/OFF function.
- Rocking mode function on the control panel for rapid trimming. Allows turning the hand-wheel back and forth over a short distance without the need of deactivating the retraction. Each change in the

sense of rotation will be electronically detected and automatically converted into an advance or retraction movement of the specimen, without compromising the ribboning of the sections.

- Motorized horizontal specimen head movement can be done in 2 ways:
  1. Using the coarse feed buttons on the control panel in two speeds per direction in continuous or in step feeding mode.
  2. Using the ergonomically positioned coarse feed wheel which can be personalized by user selectable preferred turn direction.
- Visual/acoustic signals indicate the remaining feed and the front and rear travel limits.
- Efficient and rapid specimen exchange
  1. by using the user programmable Memo position
  2. the fast homing function of the object head within 13 +/- 2 seconds from front to rear position.
- Large top surface area allows placement of objects that require a flat surface.
- Removable top tray allows storage of sectioning tools and prevents items from falling.

### 3.3 Technical Data

<b>General</b>	
Nominal supply voltages	100/120/230/240 V AC
Nominal frequency	50/60 Hz
Maximum power consumption	40 VA
Protection class	I
Power fuses	2 x T 1.0 AL, 250V
Pollution degree (according to IEC-1010, UL 3101, EN 61010)	2
Overvoltage category (according to IEC-1010, UL 3101, EN 61010)	II
IP protection class	IP20
Operating temperature range	+18 °C to +30 °C
Operating relative humidity	20 % to max. 80 % non-condensing
Operating altitude	Up to 2000 m above sea level
Transport temperature range	-29 °C to +50 °C
Storage temperature range	+5 °C to +50 °C
Transport and storage relative humidity	10 % to max. 85 % non-condensing
<b>Dimensions and weights</b>	
<b>Basic instrument</b>	
Width (including the handwheel and the coarse feed wheel)	477 mm
Depth (including the section waste tray)	620 mm
Height (without the top tray)	295 mm
Height (with the top tray)	303 mm
Weight (without accessories)	Approx. 31 kg
Volume of the section waste tray	1400 ml
<b>Control panel</b>	

**Dimensions and weights**

Width	94 mm
Depth	193 mm
Height	50 mm
Height (in inclined position)	81 mm
Weight (net)	approx. 0.5 kg

**Microtome**

## Sectioning thickness setting

Section thickness setting range	0.50 - 100 $\mu$ m
Setting values	<ul style="list-style-type: none"> <li>• From 0.5 - 5.0 <math>\mu</math>m in 0.5 <math>\mu</math>m increments</li> <li>• From 5.0 - 20.0 <math>\mu</math>m in 1.0 <math>\mu</math>m increments</li> <li>• From 20.0 - 60.0 <math>\mu</math>m in 5.0 <math>\mu</math>m increments</li> <li>• From 60.0 - 100.0 <math>\mu</math>m in 10.0 <math>\mu</math>m increments</li> </ul>

## Trimming thickness setting range

Setting values	<ul style="list-style-type: none"> <li>• 1 - 600 <math>\mu</math>m</li> <li>• From 1.0 - 10.0 <math>\mu</math>m in 1.0 <math>\mu</math>m increments</li> <li>• From 10.0 - 20.0 <math>\mu</math>m in 2.0 <math>\mu</math>m increments</li> <li>• From 20.0 - 50.0 <math>\mu</math>m in 5.0 <math>\mu</math>m increments</li> <li>• From 50.0 - 100.0 <math>\mu</math>m in 10.0 <math>\mu</math>m increments</li> <li>• From 100.0 - 600.0 <math>\mu</math>m in 50.0 <math>\mu</math>m increments</li> </ul>
----------------	---

Horizontal feed range	24 mm $\pm$ 1 mm
-----------------------	------------------

Vertical stroke length	70 $\pm$ 1 mm
------------------------	---------------

Maximum cutting range without retraction	65 mm without specimen orientation
--	------------------------------------

Maximum sectioning area with retraction	60 mm
---	-------

Maximum specimen block size for large standard clamp (H x W x D)	55 x 50 x 30 mm
--	-----------------

Maximum specimen block size for super cassette clamp (H x W x D)	68 x 48 x 15 mm
--	-----------------

Specimen retraction in manual sectioning mode	5 - 100 $\mu$ m in 5 $\mu$ m increments; can be turned off
---	--

## Electric coarse feed

• slow forward and backward buttons	• 300 $\mu$ m/s
• fast forward	• 800 $\mu$ m/s
• fast backwards (fast homing)	• 1800 $\mu$ m/s

Memo position	1
---------------	---

Coarse feed wheel turn direction clockwise or counter-clockwise	User selectable
---	-----------------

## Optional accessories

Specimen orientation with zero position

- Horizontal rotation:  $\pm 8^\circ$
- Vertical rotation:  $\pm 8^\circ$

Two-in-one blade holder

• Lateral displacement function  
East-west movement

- 3 positions

• Movement of blade holder base:

- North-south:  $\pm 24$  mm

## 4. Setting up the instrument

### 4.1 Installation site requirements

- Stable, vibration-free laboratory table with horizontal, flat table top, as far as possible vibration-free ground.
- No other instruments nearby which might cause vibrations.
- Room temperature consistently between + 18 °C and + 30 °C.
- Obstruction-free access to the handwheel.
- To ensure proper function of the instrument, it must be set up while maintaining a minimum distance of 10 cm from walls and furniture.
- The instrument must be installed in a place that ensures an easy disconnection from the power supply. The power cable must be in a place that can be easily reached.



#### Danger

Explosive hazard.

**Death or Serious injury of persons, and/or property damage.**

- Never operate the instrument in rooms with an explosive hazard.

### 4.2 Standard delivery - packing list

#### HistoCore MULTICUT configuration: 14 9MULTI0C1

Quantity	Part description	Order No.
1	HistoCore MULTICUT basic instrument	14 0518 56372
1	Fine-directional fixture for specimen clamp	14 0502 37717
1	Quick clamping system	14 0502 37718
1	Universal cassette clamp	14 0502 37999
1	Blade holder base	14 0502 55546
1	2-in-1 Blade holder E	14 0502 54497

#### HistoCore MULTICUT configuration: 14 9MULTI0C3

Quantity	Part description	Order No.
1	HistoCore MULTICUT basic instrument	14 0518 56372
1	Fine-directional fixture for specimen clamp	14 0502 37717
1	Quick clamping system	14 0502 37718
1	Universal cassette clamp	14 0502 37999
1	Knife holder base	14 0502 37962
1	Knife Holder DH	14 0517 60829
1	International bundle Instructions for Use (incl. English printout and additional languages on a data storage device 14 0517 83200)	14 0517 83001

HistoCore MULTICUT configuration: 14 9MULTI0C4

Quantity	Part description	Order No.
1	HistoCore MULTICUT basic instrument	14 0518 56372
1	Fine-directional fixture for specimen clamp	14 0502 37717
1	Quick clamping system	14 0502 37718
1	Universal cassette clamp	14 0502 37999
1	Knife holder base	14 0502 37962
1	Knife Holder DL	14 0517 60830
1	International bundle Instructions for Use (incl. English printout and additional languages on a data storage device 14 0517 83200)	14 0517 83001

HistoCore MULTICUT basic instrument includes the following delivery list.

Quantity	Part description	Order No.
	HistoCore MULTICUT basic instrument	14 0518 56372
1	Handwheel, assembly	14 0501 38181
1	Separate control panel, HistoCore MULTICUT	14 0518 56384
1	Anti-static waste tray	14 0517 56237
1	Top tray	14 0517 56261
1	Service pack	14 0503 43948
2	Fuse Lead T1.0AL, 250V	14 6000 04804
1	Schnorr-Safety Washer 10x6.4x0.7	14 3017 00073
1	Hexagon screw M6x18 DIN7984	14 2101 23130
1	Cover disc	14 3025 00008
1	International bundle Instructions for Use (incl. English printout and additional languages on a data storage device 14 0518 80200)	14 0518 80001

**It is possible to configure a basic instrument with the below listed accessories to fit your application. To have a workable configuration, at least one item of the categories mentioned below must be ordered.**

<b>Basic instrument HistoCore MULTICUT</b>	14051856372	Basic instrument HistoCore MULTICUT without all of the following: orientation, quick clamping system, specimen clamp, blade or knife holder set-up
--	-------------	--

**select one**

<b>Specimen orientation</b>	14050237717	Fine-directional fixture for specimen clamp (*)
	14050238949	Directional fixture for specimen clamp (*)
	14050238160	Rigid fixture for specimen clamp

**must be ordered in addition to fixture orienting with (\*)**

<b>Quick clamping system (*)</b>	14050237718	Quick clamping system (*)
----------------------------------	-------------	---------------------------

**Order at least one specimen clamp**

<b>Specimen clamps</b>	14050237999	Universal cassette clamp
	14050238005	Standard specimen clamp 50x55 mm
	14050237998	Standard specimen clamp 40x40 mm
	14050238967	Super cassette clamp
	14050246573	Leica RM CoolClamp
<b>Order at least one blade or knife holder base and one blade or knife holder</b>		
<b>Blade holder base and Blade holder</b>	14050255546	Blade holder base
	14050254497	2-in-1 blade holder E
<b>Knife holder base and knife holders</b>	14050237962	Knife holder base
	14050237993	Knife holder N
	14050238961	Knife holder E w/trough low-profile
<b>Blade holder base and Blade holder</b>	14050237962	Knife holder base
	14051760829	Knife Holder DH
<b>Blade holder base and Blade holder</b>	14050237962	Knife holder base
	14051760830	Knife Holder DL

**Additional optional accessories and knives/blades can be found in Chapter 6 (→ P. 62 – 6. Optional Accessories).**

The country specific power cord needs to be ordered separately. Please find a list of all power cords available for your device on our website [www.LeicaBiosystems.com](http://www.LeicaBiosystems.com) within the product section.



#### Tip

The accessories ordered are included in a separate box.

Please check all delivered parts against the packing list and against your order to verify whether the delivery is complete. Should you find any discrepancies, please contact your Leica Biosystems sales office without delay.



#### Note

- The configurations mentioned above may not be available in your country/region. Please contact your local Leica sales agent for more information.

### 4.3 Unpacking and installation



#### Warning

Accessories/instrument falling out of the package during unpacking.

**Serious injury of persons and/or property damage.**

- Be careful when unpacking the instrument.
- Once unpacked, the instrument must be moved only in an upright position.
- Thoroughly follow the instructions given in the Unpacking Instructions attached at the outside of the package or the actions described in the Instructions for Use.



**Warning**

Instrument is lifted inappropriately.

**Serious injury of persons and/or property damage.**

- When lifting the instrument touch it only at the lifting points described in the Instructions for Use and Unpacking Instructions (base plate at the front and under the instrument on the back).
- Never lift the instrument by the handwheel grip, electric coarse feed wheel, or object head.
- Always remove the section waste tray before transporting the instrument.

**Warning**

Careless moving of the instrument.

**Serious injury of hands and/or fingers due to getting crushed between instrument and working surface.**

- When moving the instrument, touch it only at the lifting points described in the Instructions for Use and Unpacking Instructions (base plate at the front and under the instrument on the back).
- Thoroughly pay attention that hands do not get between instrument and working surface.

**Warning**

Instrument not positioned safely with all 4 feet on an appropriate laboratory table.

**Serious injury of persons and/or property damage.**

- Put the instrument only on a stable, vibration-free laboratory table with horizontal, flat table top. Ground needs to be vibration-free as far as possible.
- Always make sure that all 4 feet are positioned completely on the laboratory table.
- If the instrument has been potentially moved by other persons (for example for servicing) always double-check correct positioning.

**Caution**

Accessories/components loosening/damaged during transportation.

**Property damage or delayed diagnosis.**

- The packaging has the ShockDot Impact Indicator, that indicates improper transport. When the instrument is delivered, check this first. If the indicator is triggered, the package was not handled as prescribed. In this case, please mark the shipping documents accordingly and check the shipment for damage.

**Tip**

The transport carton and included retaining elements should be kept in case a return shipment is necessary later. To return the instrument, follow the instructions below in reverse order.



Fig. 7

- Remove the packing strap and the adhesive tape (→ "Fig. 7-1").
- Remove the carton lid (→ "Fig. 7-2").



Fig. 8

- Take out the accessory carton (optional accessories) (→ "Fig. 8-3") and the cartons (→ "Fig. 8-4") for the standard scope of delivery.



Fig. 9

- Take out the fixing module (→ "Fig. 9-5"). To do so, hold it by the top edge of the module and in the recessed grip (→ "Fig. 9-6") and pull it out by pulling upwards.
- Remove the outer carton wall (→ "Fig. 9-7").
- Lift the instrument (→ "Fig. 9-8") by holding it by the base plate at the front (→ "Fig. 10-11") and under the instrument on the back (→ "Fig. 10-12") and lift it out of the formed cushion (→ "Fig. 9-9"). (The instrument illustration is provided as an example only.)

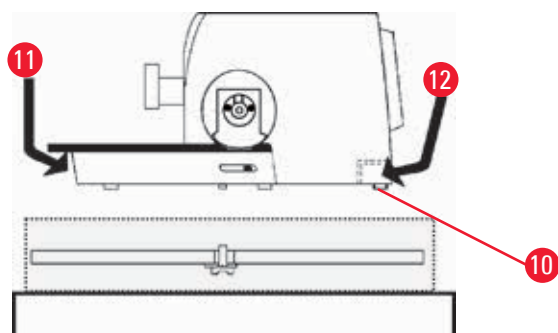

Fig. 10

- Place the instrument on a stable laboratory table. The two sliding elements (→ "Fig. 10-10") located on the rear of the base plate make it easier to move the instrument on the table.
- To move the instrument, hold it by the front of the base plate (→ "Fig. 10-11"), lift it up gently and slide it on its slides.

#### 4.4 Assembling the handwheel



##### Tip

The handwheel has to be assembled before attempting to use the instrument. The necessary parts and tools can be found in the tool kit supplied in the delivery.

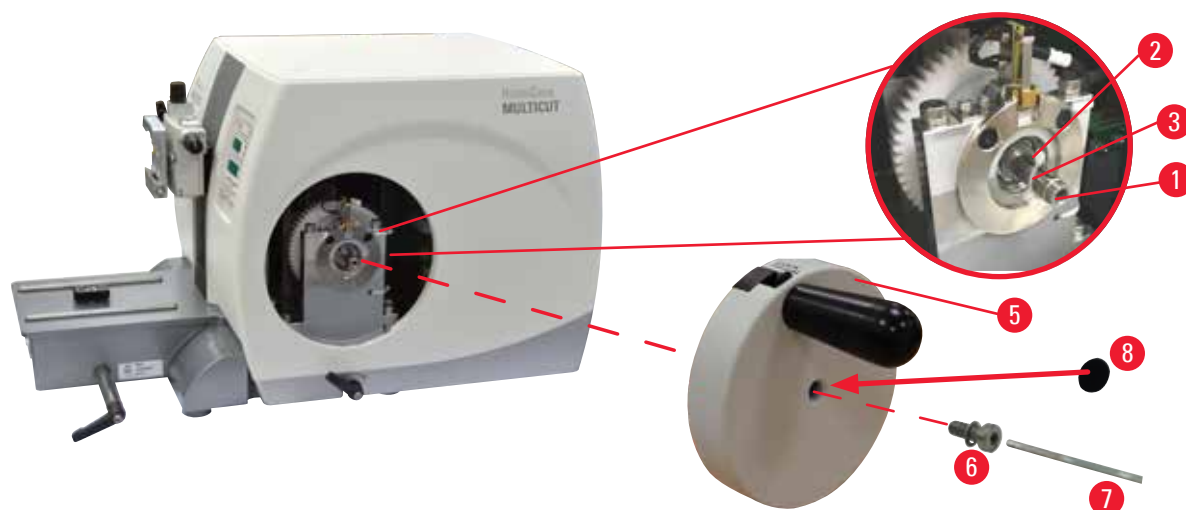

Fig. 11

The feather key (→ "Fig. 11-2") is loosely placed in the handwheel shaft (→ "Fig. 11-1") and fixed in place with a cable tie during transport.

1. Remove the cable tie (→ "Fig. 11-3").



##### Caution

The feather key is lost when mounting the handwheel.

**The instrument cannot be used, and it may cause the delay of diagnosis.**

- Before assembling the handwheel, check the feather key and make sure that it is in the handwheel shaft.
2. Place the handwheel (→ "Fig. 11-5") on the handwheel shaft (→ "Fig. 11-1") as shown.
  3. Tighten the screw (→ "Fig. 11-6") located in the center hole of the handwheel with a Hexagon key No. 4 (→ "Fig. 11-7").
  4. Remove the cover foil from the self-adhesive cover disk (→ "Fig. 11-8") and fix the cover disk on the handwheel.

## 4.5 Electrical connections



### Warning

Connecting the instrument to a non-grounded socket, or use an extension cord.

**Risk of electrical shock which causes injury to persons, or delayed diagnosis.**

- The instrument must be connected to a grounded socket.
- Do not use an extension cord.

### 4.5.1 Checking the voltage



### Warning

Wrong voltage of power supply selected at the voltage selector.

**Instrument damage, delay of specimen processing.**

- Assure the voltage is fit for your mains voltage before plugging in the instrument.
- In need of changing the voltage setting, contact Leica Biosystems service.

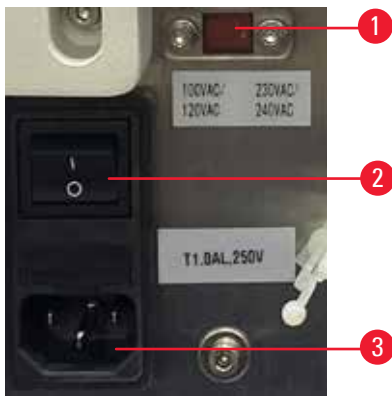

Fig. 12

The voltage selector (→ "Fig. 12-1") is located on the upper right of the main switch (→ "Fig. 12-2"), on the left-rear side of the instrument. Before switching on the instrument, check if the voltage conforms to local voltage standards. If the voltage does not conform to local standards, contact Leica Biosystems service.

### 4.5.2 Connecting the power supply

- Before connecting the power cable, make sure that the main switch (→ "Fig. 12-2") on the rear of the instrument is switched to "0" = OFF.
- Make sure that the power cable used has the correct plug for the power socket.
- Insert the connector of the power cable into the connection socket (→ "Fig. 12-3") and plug the power plug into the power socket.

### 4.5.3 Connecting the control panel



Fig. 13

The connecting cable (→ "Fig. 13-1") of the control panel is fixed to the microtome. It may not be disconnected.

1. Insert the plug (→ "Fig. 13-2") of the connecting cable into the connecting jack (→ "Fig. 13-3") on the rear of the control panel.
2. To fasten the plug, tighten the two screws (→ "Fig. 13-4").

### 4.6 Switching on the instrument



#### Warning

Condensation inside the instrument due to exposure to extreme differences in temperature and high air humidity.

#### Damage of the instrument.

- Always make sure that for both storage and operation appropriate climate conditions are met. See the section of Technical data (→ P. 27 – 3.3 Technical Data).
- After transporting the instrument, wait at least two hours to allow the instrument to adopt the ambient temperature before turning it on.



#### Tip

When turning the instrument on with the power switch, do not press any of the buttons of the control panel, except when you set specific functions. For more information, please refer to (→ P. 41 – Key combination).

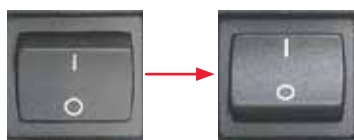

Turn the instrument on with the power switch at the rear.

I = ON; O = OFF

This is followed by a beep.

The instrument initializes.



The display (here only as an example) of the software version follows in the four-digit LED display. This display disappears after 2 seconds and "00.00" is displayed. After the microtome is switched on, the display fields and LEDs of all activated functions are lit up on the instrument's control panel and display field.



The three-digit LED display indicates the last value set for the section thickness or trimming thickness, depending on which setting was last activated. This is indicated simultaneously on the control panel and microtome. The LED of the active mode (here the section thickness) is illuminated in green.

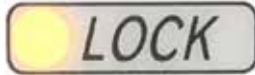

If the yellow LED in the **LOCK** field of the control panel is lit, the handwheel locking mechanism or the handwheel brake lever is activated. The instrument cannot be used as long as the LED is lit.

## 5. Operation

### 5.1 Operating elements and their functions

The operating functions of the microtome are divided between a control panel and a display unit on the microtome. A control panel on the instrument displays the current operating mode as well as various settings. All operating functions are centrally located in the separate control panel. All buttons and displays are logically arranged in functional groups and easily identifiable.



#### Warning

Improper fix to software freeze.

#### Specimen damage and/or delay of diagnose.

- In case of a software freeze follow the instructions given in chapters Troubleshooting and Operation.
- If instrument cannot set back into operation immediately, make sure that the specimen is stored in an appropriate manner to avoid any damage to it.
- If required, contact Leica Biosystems service representative.

#### 5.1.1 Instrument control panel

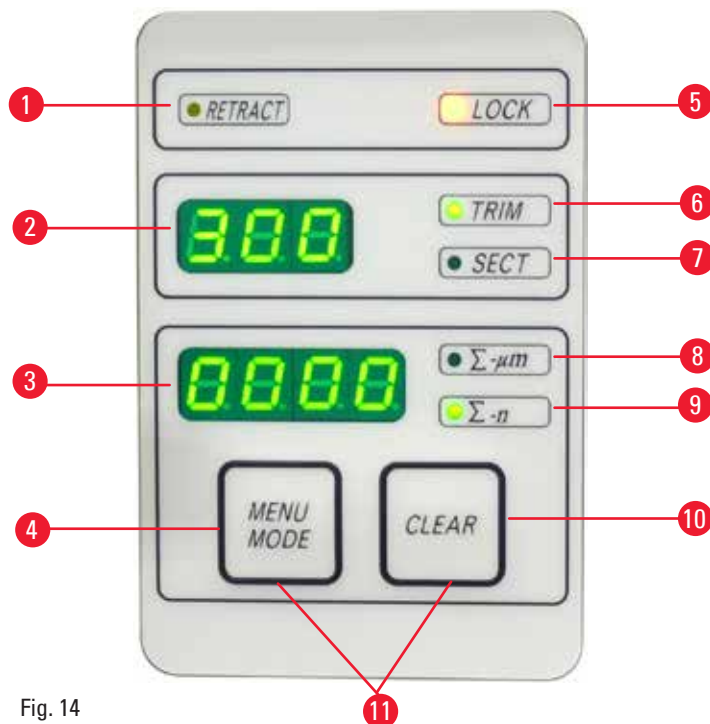

Fig. 14

- |   |                         |  |
|---|-------------------------|--|
| 1 | LED - <b>RETRACT</b>    | Lights up during specimen retraction.  |
| 2 | Three-digit display     | Displays section thickness/trimming thickness and other setting indications. |
| 3 | Four-digit display      | Displays the section counter number.   |
| 4 | <b>MENU MODE</b> button | Changes between section thickness sum and section counter.                   |

## 5 Operation

5	LED - <b>LOCK</b>	Lights up when the handwheel lock is active.
6	Green LED - <b>TRIM</b>	Lights up when the trimming mode is active.
7	Green LED - <b>SECT</b>	Lights up when the sectioning mode is active.
8	Green LED	Section thickness sum - shows the sum of all sections.
9	Green LED	Section counter - displays the number of all sections.
10	<b>CLEAR</b> button	Resets section counter and section thickness sum (to 0).
11	<b>MENU MODE + CLEAR</b>	Pressing two buttons simultaneously switches to the setting of the retraction value.

### 5.1.2 Separate control panel

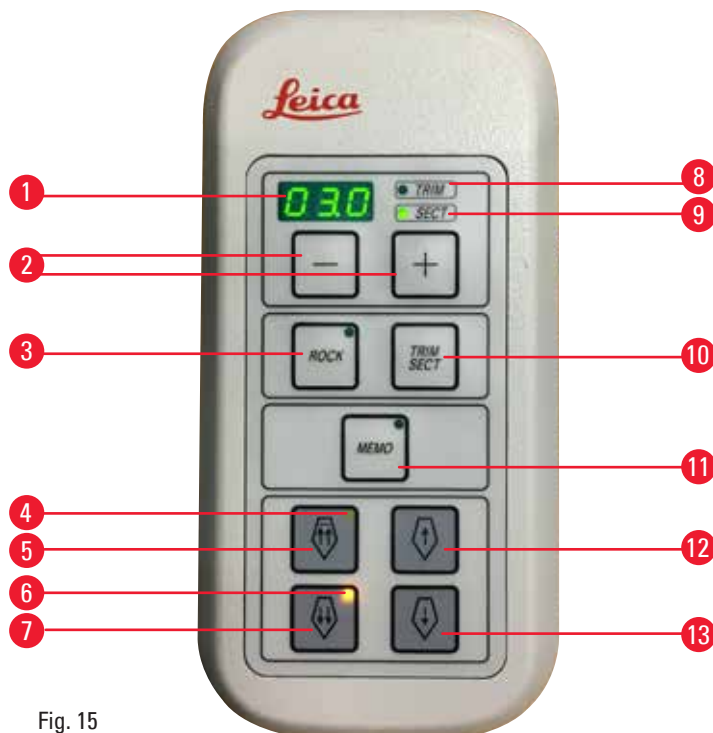

Fig. 15

1	Three-digit display	Displays section thickness/trimming thickness and other setting indications.
2	Buttons	Sets the section thickness/trimming thickness.
3	<b>ROCK</b> button	Enables/Disables the rocking mode.
4	Yellow LED	<ul style="list-style-type: none"> <li>Flashes during coarse feed backwards;</li> <li>Lights up when the rear end position is reached.</li> </ul>
5	Coarse feed button - fast backward	<ul style="list-style-type: none"> <li>In the trimming/sectioning mode: coarse feed backward fast;</li> <li>In the sectioning mode (Step mode activated): multiple step backward.</li> </ul>
6	Yellow LED	<ul style="list-style-type: none"> <li>Flashes during coarse feed forwards;</li> <li>Lights up when the remaining feed area is reached.</li> </ul>
7	Coarse feed button - fast forward	<ul style="list-style-type: none"> <li>In the trimming/sectioning mode: coarse feed forward fast;</li> <li>In the sectioning mode (Step mode activated): multiple step forward.</li> </ul>



- 8 Green LED - **TRIM** Lights up when the trimming mode is active.
- 9 Green LED - **SECT** Lights up when the sectioning mode is active.
- 10 **TRIM/SECT** button Switches between the sectioning mode and the trimming mode.
- 11 **MEMO** button Sets one memory position.
- 12 Coarse feed button - slow backward
  - In the trimming/sectioning mode: coarse feed backward slow;
  - In the sectioning mode (Step mode activated): single step backward.
- 13 Coarse feed button - slow forward
  - In the trimming/sectioning mode: coarse feed forward slow;
  - In the trimming mode (Step mode activated): single step forward.

**Key combination**

Key combination	Function
<b>MENU MODE</b> + <b>CLEAR</b> button	Set retraction value.
Switch on instrument + Minus button	Deactivate STEP mode.
Switch on instrument + Plus button	Activate STEP mode.
Switch on instrument + Slow backward button	Set the coarse feed wheel direction as counter-clockwise-forward.
Switch on instrument + Slow forward button	Set the coarse feed wheel direction as clockwise-forward.

**5.1.3 Display and control elements**

**Three-digit display**



This display is located both on the instrument control panel and on the separate control panel. If the **SECT** LED is lit up, the display shows the section thickness setting in  $\mu\text{m}$ . If the **TRIM** LED is lit up, the display shows the trimming thickness setting in  $\mu\text{m}$ .

**Selecting the sectioning and trimming mode**

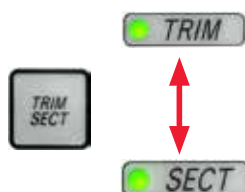

To switch between the sectioning mode and the trimming mode, press the **TRIM/SECT** button on the separate control panel. Whenever the button is pressed, the display toggles between **SECT** and **TRIM**.

In the **SECT** display, the sectioning thickness in the range from 0.50 to 100.0  $\mu\text{m}$  is shown, and in the **TRIM** display, the trimming thickness between 1.0 and 600  $\mu\text{m}$  is displayed.

## 5 Operation

### Setting the section thickness/trimming thickness



Adjust the settings using these two buttons on the separate control panel.

Section thickness setting range: 0.50  $\mu\text{m}$  - 100  $\mu\text{m}$

Setting values:

from 0.5  $\mu\text{m}$  - 5.0  $\mu\text{m}$  in 0.5  $\mu\text{m}$  increments

from 5.0  $\mu\text{m}$  - 20.0  $\mu\text{m}$  in 1.0  $\mu\text{m}$  increments

from 20.0  $\mu\text{m}$  - 60.0  $\mu\text{m}$  in 5.0  $\mu\text{m}$  increments

from 60.0  $\mu\text{m}$  - 100.0  $\mu\text{m}$  in 10.0  $\mu\text{m}$  increments

Trimming thickness setting range: 1 - 600  $\mu\text{m}$

Setting values:

from 1.0  $\mu\text{m}$  - 10.0  $\mu\text{m}$  in 1.0  $\mu\text{m}$  increments

from 10.0  $\mu\text{m}$  - 20.0  $\mu\text{m}$  in 2.0  $\mu\text{m}$  increments

from 20.0  $\mu\text{m}$  - 50.0  $\mu\text{m}$  in 5.0  $\mu\text{m}$  increments

from 50.0  $\mu\text{m}$  - 100.0  $\mu\text{m}$  in 10.0  $\mu\text{m}$  increments

from 100.0  $\mu\text{m}$  - 600.0  $\mu\text{m}$  in 50.0  $\mu\text{m}$  increments

### Coarse feed functions



Fig. 16

The electric coarse feed at two speeds is used for a rapid movement of the specimen towards and away from the knife.

With the double-arrow buttons, the coarse feed operates at 800  $\mu\text{m}/\text{s}$  when moving forwards; with the single-arrow buttons, it runs at 300  $\mu\text{m}/\text{s}$  when moving forwards and backwards.

In the sectioning mode the coarse drive can be used in STEP mode, or with continuous feed. The instrument is delivered with continuous feed (standard configuration).

#### Fast homing

Press the fast-backward coarse feed button ( $\rightarrow$  "Fig. 16-1"), the object head is moving from the front end position to the home position at 1800  $\mu\text{m}/\text{s}$ .



#### Caution

Turning the electronic coarse feed wheel during fast homing or moving to the memory position.

#### Specimen impaired.

- Do not touch the electronic coarse feed wheel during fast homing or moving to the memory position.



#### Caution

Turning the handwheel or pressing buttons on the separate control panel or the instrument control panel during fast homing or moving to the memory position.

#### Specimen impaired.

- Do not turn the handwheel or press any button on the separate control panel or the instrument control panel during fast homing or moving to the memory position.

### Sectioning mode

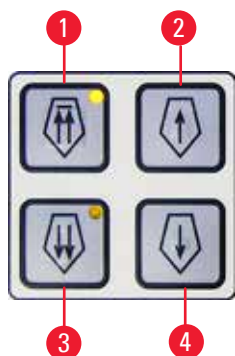

Fig. 17

In the sectioning mode the user can select between STEP function (step-by-step specimen feed) and continuous specimen feed.

When the continuous feed is selected, the coarse feed buttons have the same functions as in the trimming mode. The STEP function is useful for careful step-by-step approximation of the specimen towards the knife. How to activate the STEP function:

- Switch the instrument on while holding the + button on the control panel. (Likewise, to deactivate switch the instrument on while pressing the - button.) While the instrument is initializing, hold the + button until the software version number is no longer displayed.
- Press the **TRIM/SECT** button and select the sectioning mode (LED **SECT** lit).
- When pressing the slow coarse feed button (→ "Fig. 17-2") or (→ "Fig. 17-4") for slow-speed coarse feed, a defined, incremental feed takes place (STEP) at the value indicated on the display in the respective direction (single step).
- By short activation of the fast coarse feed buttons, a single step is also effected in the appropriate direction.
- Longer activation of the fast coarse feed button (→ "Fig. 17-1") or (→ "Fig. 17-3") effects a repeated feed motion for as long as the button is pressed.

### Trimming mode



Fig. 18

In the trimming mode, the coarse feed buttons operate a continuous movement as long as the button is held down. The double-arrow button for fast coarse feed backward movements has a lock-in function.

Do not put your fingers between the specimen clamp and microtome to prevent pinching them.

- To start the fast backwards movement (away from the knife) press the button (→ "Fig. 18-1"). After the button is pressed, the specimen head is moved to the rear end position.
- To stop the movement, press any of the four coarse feed buttons.
- The yellow LED (→ "Fig. 18-2") in the button flashes while the specimen head is in motion, and remains lit continuously when the rear end position is reached.
- Press the button (→ "Fig. 18-3") to start the slow backwards movement. The travel continues as long as the button is held pressed.
- Press the appropriate button to start a rapid or slow forward movement. The travel continues as long as the button is held pressed.
- During the forwards movement, the yellow LED (→ "Fig. 18-4") in the button flashes. When the front end position is reached, an acoustic signal is heard and the LED stops flashing and remains lit.

## One memory position

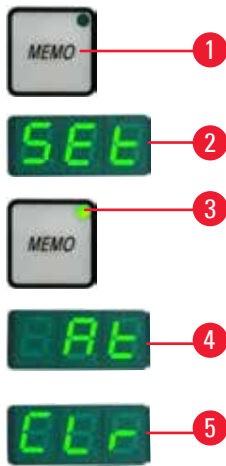

Fig. 19

Set one memory position using the **MEMO** button (→ "Fig. 19-1") on the separate control panel.

To set one memory position, move the object head to the desired position, and press the **MEMO** button. A short beep is heard; the three-digit display indicates **SEt** (→ "Fig. 19-2"); the LED (→ "Fig. 19-3") of the **MEMO** button lights up in green.

If one memory position is stored, after pressing the **MEMO** button, the object head moves to the memory position; a short beep is heard and the three-digit display indicates **At** (→ "Fig. 19-4") when the object head reaches the memory position.

To change the stored memory position, move the object head to the new position, and press on the **MEMO** button for about 1 second. A short beep is heard; the three-digit display indicates **SEt**; the green LED of the **MEMO** button keeps lighting on.

To clear the memory position, press on the **MEMO** button for more than 3 second. Two short beeps are heard; the three-digit display indicates **CLr** (→ "Fig. 19-5"); the green LED of the **MEMO** button is greyed out.



### Tip

While the object head is moving to the memory position, the movement can be stopped by pressing the **MEMO** button or any other buttons, or by rotating the electronic coarse feed wheel.

The **MEMO** button is enabled between the front limit position (not included) and home position (not included).



### Caution

Manual movement of knife/blade holder and/or object head after setting-up the memory position.

#### Damage of specimen.

- Do not move the knife/blade holder, the holder base and/or object head and do not readjust the orientation without readjusting the memory position.



### Caution

Turning the electronic coarse feed wheel during fast homing or moving to the memory position.

#### Specimen impaired.

- Do not touch the electronic coarse feed wheel during fast homing or moving to the memory position.



### Caution

Turning the handwheel or pressing buttons on the separate control panel or the instrument control panel during fast homing or moving to the memory position.

#### Specimen impaired.

- Do not turn the handwheel or press any button on the separate control panel or the instrument control panel during fast homing or moving to the memory position.



**Caution**

The memory position is set too close to the knife/blade.

**Specimen impaired.**

- Make sure that the specimen does not touch the cutting edge of the knife/blade when setting the memory position. Move the object head a little bit backward if the cutting edge touches the specimen or is positioned very close to the surface of the specimen when setting the memory position.
- Do not upload a specimen with different thickness using the same memory position.



**Caution**

Failure to reset the memory position after the instrument is switched off or after a power failure.

**Damage to specimen.**

- When the instrument is switched off or there is a power failure, previously stored memory position data is erased. Set the memory position again after powering on the instrument.

**Four-digit display on the instrument control panel**

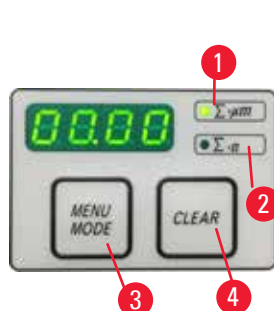

Fig. 20

The value showing on the four-digit display is adjustable.

When the  $\Sigma-\mu\text{m}$  LED ( $\rightarrow$  "Fig. 20-1") is lit, the display shows the sum of the section thicknesses in  $\mu\text{m}$  for all sections completed since the instrument was switched on.

When the  $\Sigma-n$  LED ( $\rightarrow$  "Fig. 20-2") is lit, the display shows the number of all previously completed sections.

- To change the display mode, push **MENU MODE** button ( $\rightarrow$  "Fig. 20-3") until the LED of the desired mode is illuminated.
- Press **CLEAR** button ( $\rightarrow$  "Fig. 20-4") to reset section thickness sum or section number.
- This will only reset the currently displayed value.



**Tip**

When the instrument is switched off using the main power switch, both values (section thickness sum and section number) are erased from memory.

**Specimen retraction**

To prevent damage to the knife and specimen, the specimen is moved away from the knife during the return motion to the upper home position of the object head.

The retraction value can be selected in 5  $\mu\text{m}$  increments between 5 and 100  $\mu\text{m}$ . Specimen retraction is set to 10  $\mu\text{m}$  at the factory.

Specimen retraction can be disabled if required.

The selected setting is maintained when the instrument is turned off.

## 5 Operation

### Configuring the retraction settings

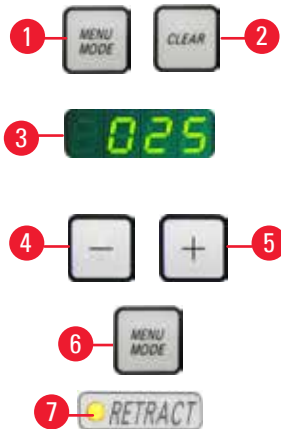

Fig. 21

- To call up the retraction settings, press the **MENU MODE** (→ "Fig. 21-1") and **CLEAR** (→ "Fig. 21-2") buttons simultaneously.
- The current set value is displayed as a three-digit number in the four-digit display, e.g. 025 = 25  $\mu\text{m}$  (→ "Fig. 21-3").
- Select the desired retraction value. The retraction value can be adjusted in increments of 5  $\mu\text{m}$  to a maximum of 100  $\mu\text{m}$  using buttons (→ "Fig. 21-4") or (→ "Fig. 21-5") on the separate control panel. The setting can be off too.
- To exit the retraction settings, press **MENU MODE** (→ "Fig. 21-6"). A retraction movement takes place by the newly selected value after each section.
- While the specimen is in retraction, the yellow LED (→ "Fig. 21-7") on the **RETRACT** display lights up.

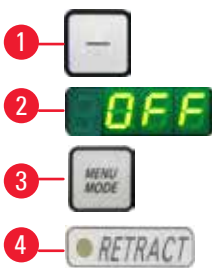

Fig. 22

- To switch off retraction, press the button (→ "Fig. 22-1") on the separate control panel until the display indicates **OFF** (→ "Fig. 22-2").
- To exit the retraction settings, press **MENU MODE** (→ "Fig. 22-3"). When retraction is switched off, the specimen is not retracted. The yellow LED (→ "Fig. 22-4") of the **RETRACT** display does not light up.

### Indication of remaining horizontal feed

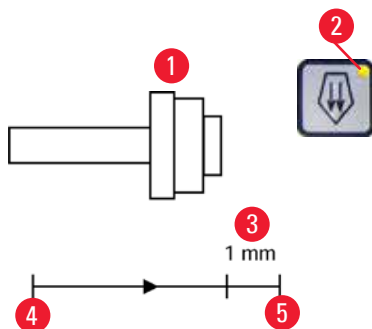

Fig. 23

The visible and audible remaining feed indication feature informs the user during trimming and sectioning when a remaining feed of approximately 1 mm (→ "Fig. 23-3") is available before the front limit is reached.

The yellow LED (→ "Fig. 23-2") in the coarse feed button lights up from the beginning of the remaining feed.

In addition, an acoustic signal is heard for approx. 2 seconds.

From this point on, a remaining feed of approx. 1 mm is available. In the remaining feed area, no more object feeding to the knife is possible using the coarse feed buttons and the electronic coarse feed wheel.

- You can continue with your working routine.
- The yellow LED (→ "Fig. 23-2") in the coarse feed button lights up.
- When the front end position (→ "Fig. 23-5") is reached, no more infeed takes place; this also means that no sectioning takes place.
- You can continue to work on the specimen by pressing the corresponding coarse feed button (→ "Fig. 24") in the rear end position (→ "Fig. 23-4") and continuing with sectioning.



Fig. 24



**Tip**

To continue your work, you must press **TRIM/SECT** button to switch to trimming mode, as otherwise, you cannot use the coarse feed.

If the specimen head is already in the remaining feed range when the instrument is switched on, an additional acoustic signal is heard after the software version is displayed.

- You can continue to work on the specimen by moving it back a short distance using the coarse feed buttons (set trimming mode.).
- The STEP function is disabled in the remaining feed range.

**5.1.4 Electronic coarse feed wheel**



Fig. 25

The coarse motion serves for a fast horizontal forwards movement of the specimen - towards the knife - and backwards - away from the knife. The rotation of the electronic coarse feed wheel (→ "Fig. 25-1") can be set as clockwise or counterclockwise to advance the object head.



Fig. 26

- To set clockwise rotation to advance the object head, switch the instrument on while holding the slow-forward coarse feed button (→ "Fig. 26-1") on the separate control panel; three-digit display indicates **C** for clockwise (→ "Fig. 26-2").

- To set counterclockwise rotation to advance the object head, switch on the instrument and press the slow-backward coarse feed button (→ "Fig. 26-3"); three-digit display indicates **CC** for counterclockwise (→ "Fig. 26-4").

The settings of the electronic coarse feed wheel rotation is shown for about 4 seconds on the three-digit display when the instrument switches on. The factory-set rotation direction of the electronic coarse feed wheel is clockwise.



## 5 Operation

### 5.1.5 Fine directional specimen holder fixture



#### Tip

In the quick clamping system of the directional specimen holder fixture, all specimen clamps available as optional accessories can be used.

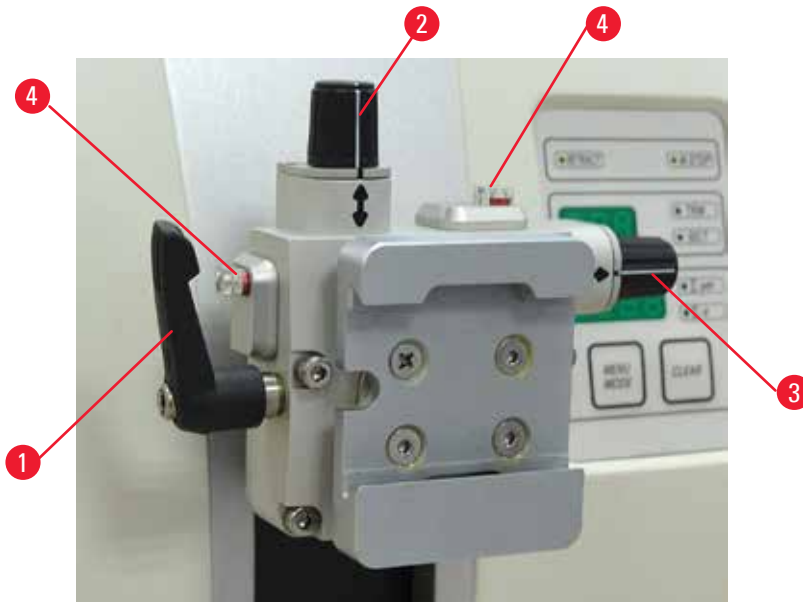

Fig. 27

The specimen orientation allows for simple position correction of the specimen surface when the specimen is clamped into place.

The directional specimen holder fixture may be exchanged for a non-directional fixture (optional accessory).

#### Display of the zero position

For better display of the zero position, the orientation has two red indicators (→ "Fig. 27-4").

When both indicators are fully visible and both setscrews are in zero position at the same time (white markings align with the arrows), the specimen is in zero position.

#### Orienting the specimen



#### Warning

Specimen is oriented in retraction phase.

#### Specimen damage due to re-orienting the specimen in retraction phase.

- Specimen blocks must not be oriented during the retraction phase. If a block is oriented during retraction, the block will advance by the retraction value plus the selected section thickness before the next section. This may cause damage to both specimen and knife/blade.

1. Raise the object head to the upper end position and activate the handwheel locking mechanism.
2. To release the clamp, turn the eccentric lever (→ "Fig. 27-1") clockwise.



3. Turn setscrew (→ "Fig. 27-2") to orient the specimen in vertical direction. Turn setscrew (→ "Fig. 27-3") to orient the specimen in horizontal direction. Each complete turn of the screw inclines the specimen by 2°. A total of 4 complete turns = 8° are possible in every direction. The accuracy is approximately ± 0.5°. For ease of estimation, there is a white mark on the handle and a click stop that is noticeable during turning.
4. To lock the current orientation, turn the eccentric lever (→ "Fig. 27-1") counterclockwise.



**Tip**

When the large standard specimen clamp (50 x 55 mm) or the super cassette clamp is used, the specimen orientation of ± 8° in north-south direction is no longer possible. The usable angle for the large standard specimen clamp (50 x 55 mm) is only about ± 4° in this case.

**5.1.6 Fine adjustment of the force balance**



Fig. 28

If another accessory of a different weight is mounted on the object head (→ "Fig. 28-1"), you must check whether it is necessary to readjust the force balance.

- Attach the new accessory and clamp the specimen.
- Set the object head to half the height of the vertical travel range by turning the handwheel (→ "Fig. 28").

If the object head remains in this exact position, the setting is correct.

If the object head moves, i.e. it is raised or lowered, fine adjustment is necessary.



**Warning**

Wrong fine adjustment of the force balance.

**Serious injury of the operator due to contact with knife and/or specimen damage.**

- Before working with the instrument, always double-check that the fine adjustment of the force balance is properly set.
- If fine adjustment is not properly set, do not work with the instrument but perform a readjustment.
- Especially after changing accessories at the object head, perform a fine adjustment of the force balance immediately.

## 5 Operation



Fig. 29

The force balance is adjusted using the screw (→ "Fig. 29-1"), which can be accessed by removing the section waste tray on the bottom of the base plate of the microtome. Use the Hexagon key No. 5 (with handle) for the adjustment.

- If the object head moves downwards, turn the screw (→ "Fig. 29-1") approx. 1/2 turn clockwise each time.
- If the object head moves upwards, turn the screw (→ "Fig. 29-1") approx. 1/2 turn counterclockwise each time.
- Continue this procedure until the object head no longer moves once released.



### Tip

Repeat the adjusting procedure several times till the object head no longer moves.

## 5.2 Inserting the two-in-one blade holder E

### 5.2.1 Setting up the blade holder base

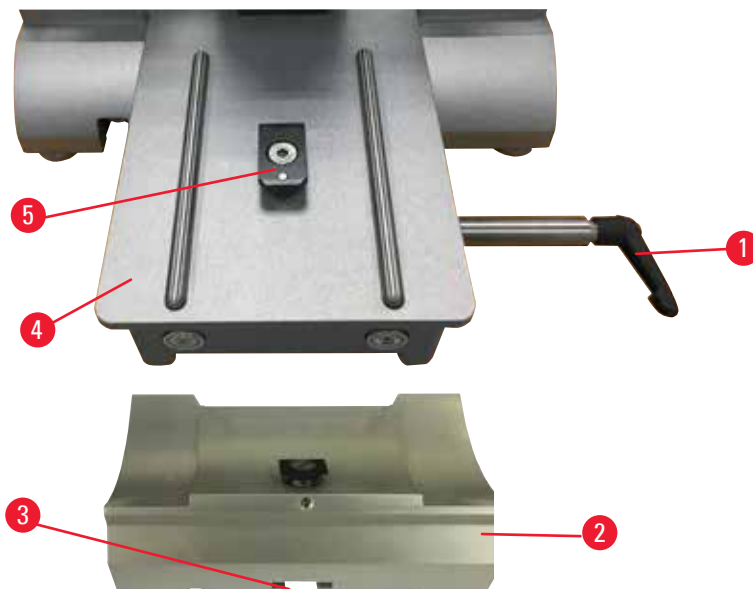

Fig. 30

1. Release the clamping lever (→ "Fig. 30-1") by rotating it counterclockwise.
2. Insert the blade holder base (→ "Fig. 30-2") using the notch (→ "Fig. 30-3") on the bottom into the T-piece (→ "Fig. 30-5") of the microtome base plate (→ "Fig. 30-4").

3. The blade holder base (→ "Fig. 30-2") can be moved back and forth on the microtome base plate. This allows bringing the two-in-one blade holder E to optimal sectioning position in relation to the specimen. To secure the blade holder base, turn the clamping lever (→ "Fig. 30-1") clockwise.

### 5.2.2 Inserting the two-in-one blade holder E

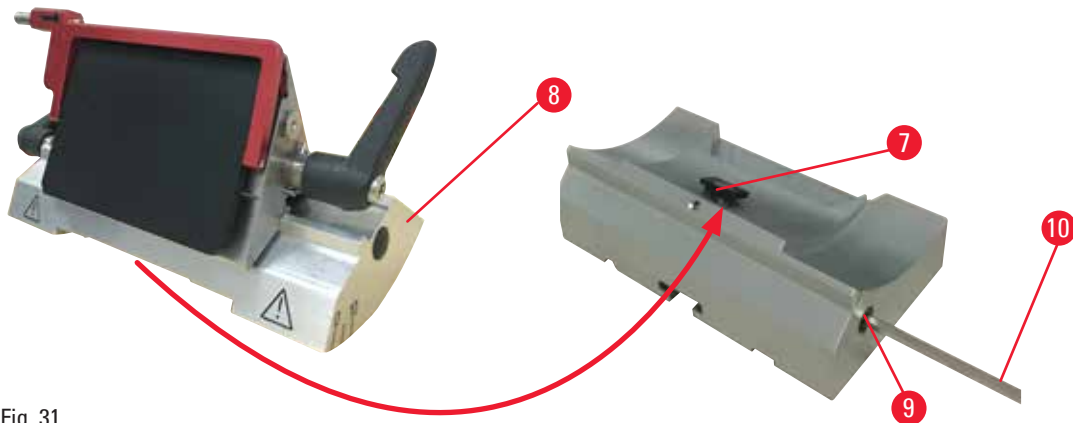

Fig. 31

1. Loosen the eccentric bolt (→ "Fig. 31-9") using a Hexagon key No. 4 (→ "Fig. 31-10").
2. Place the two-in-one blade holder E (→ "Fig. 31-8") with the underside groove onto the T-piece (→ "Fig. 31-7") of the knife holder base (→ "Fig. 30-2").
3. To clamp, retighten the eccentric bolt (→ "Fig. 31-9").

### 5.3 Adjusting the clearance angle



Fig. 32

The index marks (0°, 5° and 10°) for adjustment of the clearance angle (→ "Fig. 32-4") are located on the right side of the two-in-one blade holder E (→ "Fig. 32-2"). There is also an index mark (→ "Fig. 32-5") on the right side of the blade holder base (→ "Fig. 32-1") which serves as a reference point when adjusting the clearance angle.

1. Loosen the screw (→ "Fig. 32-3") using a Hexagon key No. 4 (→ "Fig. 32-6") until the two-in-one blade holder E (→ "Fig. 32-2") can be moved.

## 5 Operation

2. Move the two-in-one blade holder E until the index mark of the desired clearance angle coincides with the reference line on the blade holder base. Enlarged detail (→ "Fig. 32") shows a clearance angle setting of 5°.



### Tips

The recommended clearance angle setting for the two-in-one blade holder E is approx. 2.5° - 5°.

3. Hold down the two-in-one blade holder E in this position and retighten the screw (→ "Fig. 32-3") for clamping.

### 5.4 Inserting the universal cassette clamp

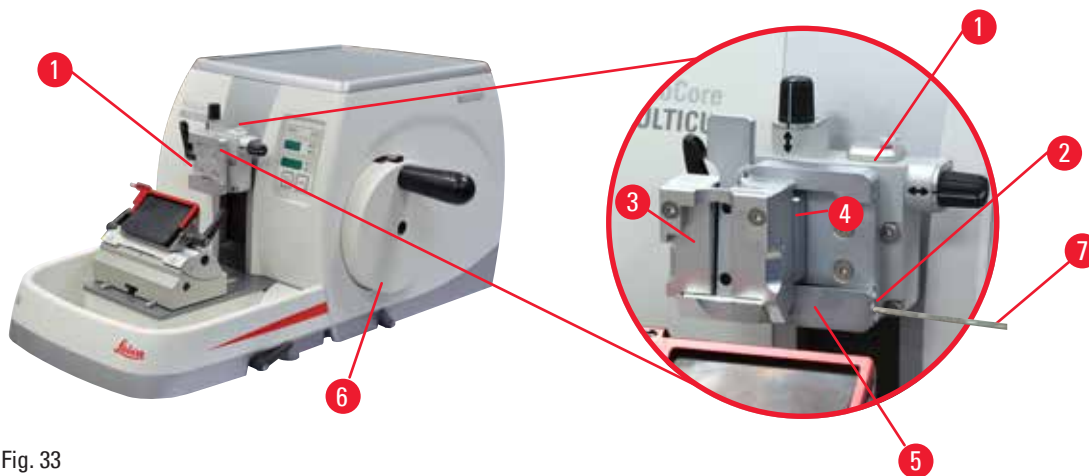

Fig. 33

There are two specimen holder fixtures with orientation and one without, please see (→ P. 62 – 6. [Optional Accessories](#)). The specimen orientation allows for simple position correction of the specimen surface when the specimen is clamped into place. You can use the quick clamping system (→ "Fig. 33-5") to hold all available accessory specimen clamps (for more information, see (→ P. 62 – 6. [Optional Accessories](#))).

To do so, proceed as follows:

1. Move the object head (→ "Fig. 33-1") to the upper end position by turning the handwheel (→ "Fig. 33-6") and engage the handwheel locking mechanism.
2. To release the clamping system, turn the screw (→ "Fig. 33-2") of the quick clamping system (→ "Fig. 33-5") counterclockwise using a Hexagon key No. 4 (→ "Fig. 33-7").
3. Push the guide (→ "Fig. 33-4") of the universal cassette clamp (→ "Fig. 33-3") from the left into the quick clamping system (→ "Fig. 33-5") as far as it will go.
4. To clamp the cassette clamp turn the screw (→ "Fig. 33-2") clockwise as far as it will go.



### Tip

Since all specimen clamps available as accessories are equipped with the same kind of guide on the back, they are inserted in the same way described here using the example of the cassette clamp.

## 5.5 Clamping the specimen



### Warning

The operator grabs into the knife or blade due to inappropriate working procedure.

**Serious injury of persons when putting the specimen in place if knife or blade has been installed before.**

- Prior to uploading the specimen on the microtome, make sure that the cutting edge has been covered by the safety guard and the hand wheel locking mechanism has been activated. Once the operator wants to upload the specimen as well as inserting a knife/blade, always upload the specimen block before mounting and clamping the knife/blade.

1. Rotate the handwheel until the specimen clamp is in the upper end position.
2. Lock the handwheel or activate the handwheel locking mechanism (→ P. 23 – 2.3.1 Locking the handwheel).
3. Insert a specimen into the specimen clamp.



### Tip

A detailed description for inserting the specimen into various specimen clamps and specimen holders is provided in (→ P. 62 – 6. Optional Accessories).

## 5.6 Clamping the knife/disposable blade



### Warning

Knives or blades are handled and/or disposed in an inappropriate manner.

**Serious injury of persons due to contact with extremely sharp knives and/or blades.**

- Work especially thoroughly and carefully when handling knives and/or blades.
- Always wear dedicated clothes (including cut-resistant gloves) when handling knives and/or blades.
- Dispose knives and blades always in a safe place (for example, dedicated knife case) and an appropriate manner that ensures that people cannot get hurt.
- Never place a knife anywhere with the cutting edge facing upwards and never try to catch a falling knife.
- Always cover the edge of the knife/blade with the safety guard before clamping the specimen.



### Warning

The operator installs two knives and/or blades on the knife and/or blade holder.

**Serious injury of persons due to contact with extremely sharp knives and/or blades.**

- Do not clamp two knives/blades on the knife holder/blade holder. Install the knife/blade in the center of the knife/blade holder. Knives/Blades must not exceed the edge of the knife/blade holder.

## 5 Operation



### Warning

Too thick or thin blade used in the two-in-one blade holder.

#### Sample impaired.

- Use a blade with a maximum thickness of less than 0.322mm and a minimum thickness of more than 0.246mm.
- The recommended compatible blade is listed in Optional Accessories (→ P. 62 – 6. Optional Accessories).



### Warning

The blade is not installed completely parallel to the upper edge of the pressure plate due to excess paraffin, uncleaned inserts, etc..

**When using the lateral movement function, failure to install the blade parallel to the pressure plate may result in poor sectioning results. For example, if a section is too thick or thin, chattering within the section, in the worst-case scenario, may damage the specimen.**

- Do not continue the sectioning when getting unsatisfying section results.
- Re-install the blade and make sure that it is parallel to the upper edge of the pressure plate.
- Always check the parallelism between the blade and pressure plate after moving the blade using the lateral movement function.
- Ensure there is no paraffin waste and the insert is clean before use.

### Inserting high-profile blades

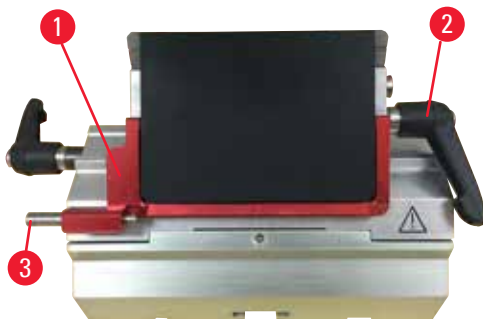

Fig. 34

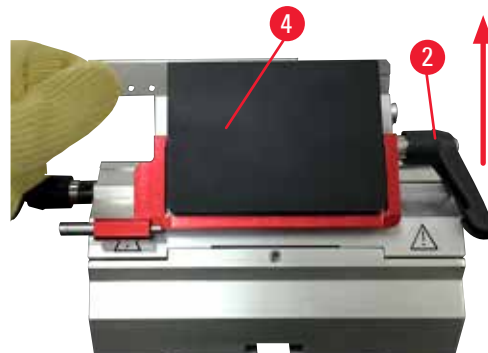

Fig. 35

1. Bring the safety guard (→ "Fig. 34-1") down.
2. To insert the blade, rotate the right clamping lever (→ "Fig. 34-2") counterclockwise.
3. Carefully push in the blade from above or from the side. Make sure that the blade is positioned in the center and, most importantly, parallel to the upper edge of the pressure plate(→ "Fig. 35-4").
4. To clamp the blade, rotate the clamping lever (→ "Fig. 34-2") clockwise.

### Inserting low-profile blades



Fig. 36



Fig. 37

When using low-profile blades, the insert (→ "Fig. 37-1") for low-profile blades must first be placed in the two-in-one blade holder E and make sure that the bottom edge of the insert fits closely to the groove of the blade holder.

Two magnets are attached to the rear side of the insert (→ "Fig. 36-1"). They point away from the operator (towards the rear pressure plate) after the insert has been inserted with the rounded edges showing upwards. Make sure that the insert is pushed all the way down and allows the blade to sit parallel to the cutting edge - if this is not done properly there is risk of damaging the specimen. Then insert the blade as described (for high profile blade) (→ P. 54 – Inserting high-profile blades).

**Removing the blades**

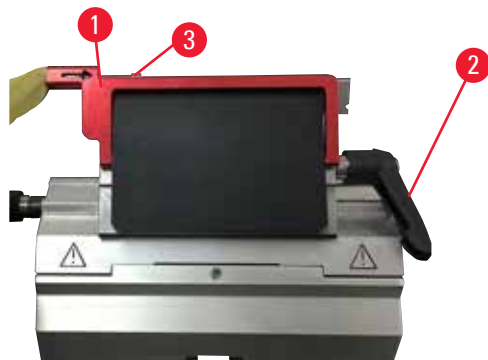

Fig. 38



Fig. 39

1. Rotate the clamping lever (→ "Fig. 38-2") counterclockwise.
2. Push the pin (→ "Fig. 38-3") on the blade ejector .



**Tips**

Use the blade ejector to safely eject the blade.

3. Bring the safety guard (→ "Fig. 39-1") down. Use the brush with magnet (→ "Fig. 39-4") to remove the blade from the right side and out.

Once the blade has been removed from the two-in-one blade holder E, it is disposed in the used blade container on the downside of the blade dispenser (→ "Fig. 40").



Fig. 40



### Warning

Knives or blades are handled and/or disposed in an inappropriate manner.

**Serious injury of persons due to contact with extremely sharp knives and/or blades.**

- Work especially thoroughly and carefully when handling knives and/or blades.
- Always wear dedicated clothes (including cut-resistant gloves) when handling knives and/or blades.
- Dispose knives and blades always in a safe place (for example, dedicated knife case) and an appropriate manner that ensures that people cannot get hurt.
- Never place a knife anywhere with the cutting edge facing upwards and never try to catch a falling knife.
- Always cover the edge of the knife/blade with the safety guard before clamping the specimen.



### Tip

Detailed descriptions for inserting the knife into the individual knife holders are provided in ([→ P. 62 – 6. Optional Accessories](#)).

## 5.7 Trimming the specimen



### Warning

Wheel turn direction of electric coarse feed incorrectly selected.

**Specimen damage.**

- Always assure that you have selected the correct turn direction of the coarse feed wheel before turning the wheel.



### Caution

Rotating the handwheel and the coarse feed wheel at the same time.

**Specimen damage.**

- Do not turn the coarse feed wheel whilst rotating the handwheel.





Fig. 41

- Use the **TRIM/SECT** button to select the **TRIM** mode.
- Set the desired trimming thickness.
- Release the handwheel locking mechanism and the handwheel brake lever.
- In **TRIM** mode, use the coarse feed buttons or electronic coarse feed wheel to move the specimen towards the knife/blade.
- Trim the specimen by turning the handwheel or the coarse feed wheel or
- Press the **ROCK** button (LED (→ "Fig. 41-1") in button is lit) to select **ROCK** mode. Trim the specimen by rocking the handwheel back and forth.
- Terminate trimming when the desired sectioning surface and depth have been reached.



**Warning**

When doing fast manual trimming and fingers are put between the specimen and the knife/blade after the handwheel is released.

**Operator can get cut and injured due to the turning of the handwheel when it is unlocked.**

- Do not put fingers between the specimen and the knife/blade during trimming and sectioning.

**5.8 Sectioning**



**Warning**

Personnel with insufficient qualification working with the instrument.

**Serious injury of persons and or specimen damage can occur when specimen approaches knife/blade due to inappropriate operator actions, for example, because object head may drop onto knife holder when handwheel is unlocked.**

- Always make sure that only laboratory personnel with dedicated and sufficient training and qualification operates the instrument.
- Always make sure that all laboratory personnel designated to operate this instrument has read these Instructions for Use carefully and is familiar with all technical features of the instrument before start working with it.



**Warning**

Personal protective equipment is not used.

**Injury of persons.**

- When working with microtomes, personal safety precautions must always be taken. It is mandatory to wear work safety shoes, safety gloves, a mask and safety goggles.

**Warning**

Working with the instrument and brittle specimen without appropriate protective clothes.

**Serious injury of persons by splinters while cutting brittle specimen.**

- Always wear appropriate protective clothes (including safety goggles) and work especially carefully when cutting brittle specimen.

**Warning**

Insufficient frame conditions for sectioning.

**Specimen damage or poor sectioning results, for example, sections alternating in thickness, compressed, folded or stripped sections.**

- Do not continue sectioning if you recognize insufficient sections results.
- Make sure that all prerequisites for appropriate sectioning are met. Refer to the troubleshooting section of these Instructions for Use for further details.
- If you do not have sufficient knowledge in regards of troubleshooting insufficient sectioning results consult persons who do have that knowledge, for example, application experts of Leica Biosystems.

**Warning**

Turning the handwheel counterclockwise.

**People injury/Damage to specimen.**

- Do not turn the handwheel counterclockwise, which may lead to handwheel locking mechanism malfunction.

**Warning**

The rotation speed of the handwheel does not suit the hardness of the specimen.

**Instrument damage and possibly specimen damage.**

- The rotation speed of the handwheel must be adapted to suit the hardness of the specimen. For harder specimens, use a slower speed.

**Warning**

In the manual sectioning mode, the user cuts the specimen block by rotating the handwheel at a very high speed.

**It may lead to poor sectioning quality and even damage the specimen.**

- In the manual sectioning mode, the rotation speed of the handwheel shall be no more than 60 rpm.

**Caution**

After the knife/blade holder is laterally displaced, the specimen is not retracted and retrimmed.

**Specimen damage.**

- Retract the object head and retrim the specimen block each time after laterally displacing the knife/blade holder.



**Caution**

After trimming by using the electronic coarse feed, the user does not switch to sectioning mode.

**Specimen damage or unexpected functioning of the instrument.**

- After completion of trimming with the electronic coarse feed remember to switch back to sectioning mode.
- Before starting sectioning always make sure that an appropriate sectioning thickness has been selected.



**Note**

Accessories and components experience corrosion due to using corrosive/strongly acidic/alkaline reagent or solvent with the instrument or accessories, such as decalcified solution that contains acid, ammonium hydroxide that contains alkali, etc.

**Accessories can malfunction.**

- Avoid corrosive/strongly acidic/alkaline reagent or solvent dripping onto the instrument surface or accessories.
- If such reagent or solvent has dripped onto the instrument surface or accessories, wipe off the residue and dry the accessories sufficiently as soon as possible.
- If such reagent or solvent is used frequently, carry out a thorough daily cleaning of the blade holder, the universal cassette clamp (UCC), and other accessories if necessary.



Fig. 42

Always use a different area of the cutting edge for trimming and sectioning.

- To do so, laterally displace the knife/blade holder. When using the two-in-one blade holder E with lateral displacement, it is sufficient to move the blade holder sideways.
- Use the **TRIM/SECT** button to select the **SECT** mode.
- Adjust the appropriate sectioning thickness or verify the selected value.
- Select conventional sectioning.
- To section the specimen, turn the handwheel clockwise smoothly.
- Pick up the sections.

**5.9 Changing the specimen or interrupting sectioning**



**Warning**

The handwheel is unlocked and the object head drops into knife/blade holder.

**People injury/Damage to specimen.**

- Except sectioning phase, the handwheel must be locked at all times.

## 5 Operation



### Warning

Specimen is oriented in retraction phase.

#### **Specimen and knife/blade damage due to re-orienting the specimen in retraction phase.**

- Specimen blocks must not be oriented during the retraction phase. If a block is oriented during retraction, the block will advance by the retraction value plus the selected section thickness before the next section. This may cause damage to both specimen and knife/blade.



### Warning

Knife/blade is not covered with the appropriate guard when not sectioning specimen.

#### **Serious injury of persons.**

- Always cover the knife/blade edge with the safety guard prior to any manipulation of knife/blade or specimen clamp, prior to changing the specimen and during all work breaks.



### Warning

Uploading or unloading the specimen on the microtome without appropriate clothes and in an inappropriate manner.

#### **Operator can get cut and injured which can lead to serious consequences.**

- Always use cut resistant safety gloves when handling the specimen within the microtome.
- Lock the handwheel and cover the knife edge with the safety guard prior to any manipulation of the specimen clamp and prior to changing the specimen.

1. Raise the specimen to the upper end position and activate the handwheel locking mechanism.
2. Cover the sectioning edge with the safety guard.
3. Remove the specimen from the specimen clamp and mount a new sample to continue.
4. Before cutting into a new specimen, move the specimen head back to the rear end position.



Fig. 43

### 5.10 Finishing the daily routine



### Warning

Section waste tray falling down after it has been detached.

#### **Injury of persons.**

- Work especially carefully when detaching the section waste tray and put it in a safe place.



### Warning

Knife/blade was not removed when knife/blade holder was uninstalled from the microtome.

#### **Serious injury of persons due to contact with extremely sharp knife/blade.**

- Before uninstalling the knife/blade holder from the microtome always make sure to detach the knife/blade wearing cut-resistant gloves and store the knife/blade in a safe place.

**Warning**

Knife/blade stored in inappropriate manner.

**Serious injury of persons, for example, due to unexpected fall off.**

- Always store knife/blade in an appropriate place when not using them, for example, store it in the dedicated knife case.
- Never place a knife anywhere with the cutting edge facing upwards and never try to catch a falling knife.

**Warning**

Paraffin waste falls on the floor and is not cleaned-up.

**Serious injury of persons, for example, by slipping and stumbling into the knife/blade.**

- Always clean up paraffin waste before it spreads, becomes slippery, and becomes a hazard.
- Wear appropriate shoes.

1. Move the specimen to the upper end position by turning the handwheel and engage the handwheel locking mechanism.
2. Remove the blade from the two-in-one blade holder E and insert it in the receptacle at the bottom of the dispenser, or remove the knife from the knife holder and put it back in the knife case.
3. Remove the specimen from the specimen clamp.
4. Move the object head to the rear end position or move the knife holder on the knife holder base outwards.
5. Push all section debris into the section waste tray and empty the tray.
6. Switch the instrument off at the main power switch.
7. Clean the instrument (→ P. 98 – 8.1 [Cleaning the instrument](#)).

## 6. Optional Accessories

### 6.1 Assembly for fixture for specimen clamps



#### Tips

Depending upon the purchase order, the basic instrument is delivered with the fine directional, directional or rigid fixture for specimen clamps which must be assembled first. All specimen clamps available as accessories can be used in one of the three fixtures for specimen clamps.

Before assembling the fixture for specimen clamps, activate the handwheel locking mechanism.

#### 6.1.1 Rigid fixture for specimen clamps



#### Tips

Remove the rubber ring (→ "Fig. 44-5") only after attaching the object head.

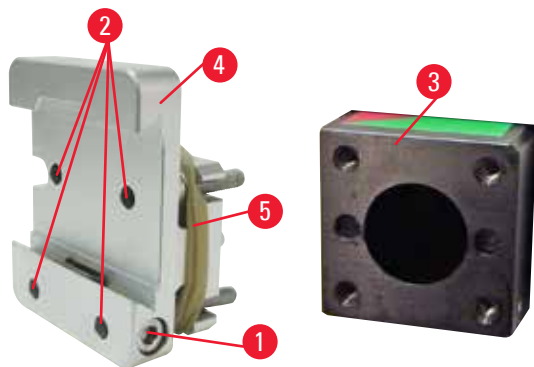

Fig. 44

Screw the rigid fixture for specimen clamps (→ "Fig. 44-4") onto the object head (→ "Fig. 44-3").

- Remove the screw (→ "Fig. 44-1"), place the specimen holder fixture (→ "Fig. 44-4") onto the object head (→ "Fig. 44-3") from the front and tighten the screws (→ "Fig. 44-2") with a Hexagon key No. 3.
- Next, insert the screw (→ "Fig. 44-1") from the side and briefly tighten it with a Hexagon key No. 4.

### 6.1.2 Directional fixture for specimen clamps

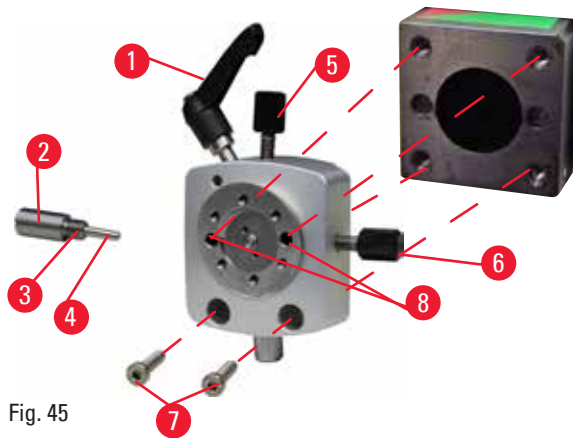

Fig. 45

- Loosen the eccentric bolt (→ "Fig. 45-1") by turning it counterclockwise.
- Completely unscrew the thrust piece (→ "Fig. 45-2") with a flat-tip screwdriver and pull it out with spring (→ "Fig. 45-3") and pin (→ "Fig. 45-4").
- Completely unscrew the setscrews (→ "Fig. 45-5") and (→ "Fig. 45-6").
- Install the directional fixture for specimen clamps by tightening the screws in the bores (→ "Fig. 45-8") (2 screws are accessible through the bores) and screw them in using a Hexagon key No. 3. Insert the screws (→ "Fig. 45-7") in the bores as shown and screw them in using a Hexagon key No. 3.
- Insert the spring (→ "Fig. 45-3") and pin (→ "Fig. 45-4") with the flatter side into the thrust piece (→ "Fig. 45-2"). Completely screw in the thrust piece with a flat-tip screwdriver.
- Completely screw in the setscrews (→ "Fig. 45-5") (→ "Fig. 45-6").

### 6.1.3 Fine-directional fixture for specimen clamps

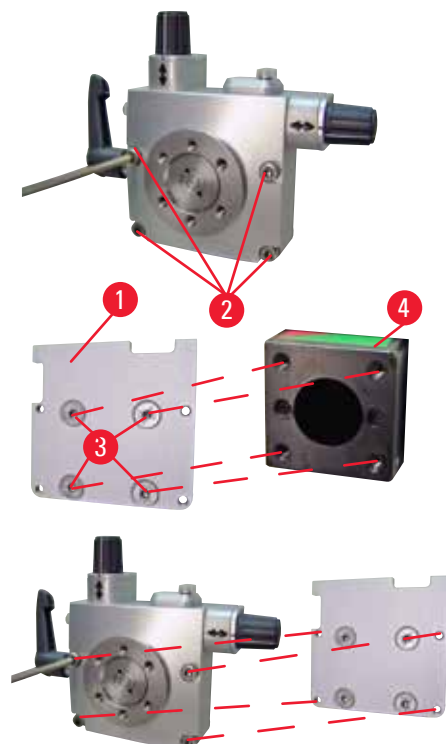

Fig. 46

- Before the fine-directional fixture for specimen clamps can be mounted, loosen 4 screws (→ "Fig. 46-2") (Hexagon key No. 3) and carefully remove the fixture for specimen clamps from the baseplate (→ "Fig. 46-1").
- Using the 4 supplied screws (→ "Fig. 46-3") and the Hexagon key No. 3, fasten the baseplate to the object head (→ "Fig. 46-4").
- Now, screw the fine-directional fixture for specimen clamps with the 4 screws (→ "Fig. 46-2") and the Hexagon key No. 3 onto the object head.



### Tips

If the fine-directional fixture for specimen clamps is not used, retain the baseplate (→ "Fig. 46-1") and 4 screws (→ "Fig. 46-3") together with the fine-directional fixture for specimen clamps.

#### 6.1.4 Quick clamping system

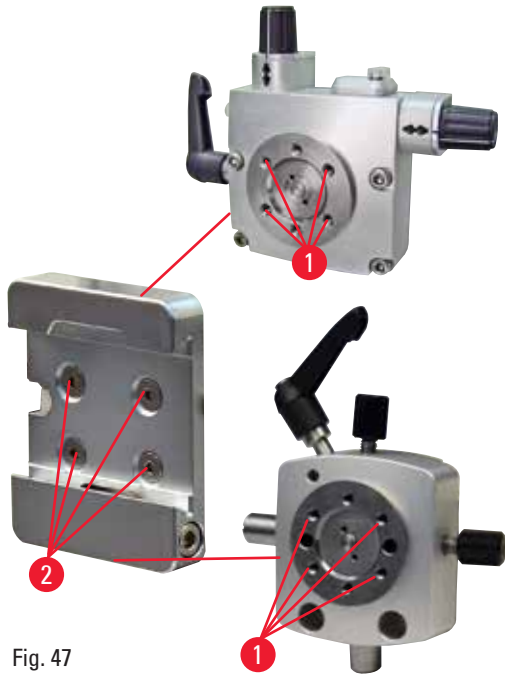

Fig. 47

It is used as an adaptor for use with the fine-directional fixture for specimen clamps with zero point indicators or the directional fixture for specimen clamps.

Screw the 4 screws (→ "Fig. 47-2") into bore (→ "Fig. 47-1") with a Hexagon key size 2.5 and tighten them.

#### 6.2 Specimen clamps and holders



### Tips

All specimen clamps available as accessories can be integrated into the fine directional, or directional, or non-directional specimen holder fixtures. For how to install the specimen clamps and holders to the quick clamping system, please refer to (→ P. 52 – 5.4 Inserting the universal cassette clamp).



### 6.2.1 Standard specimen clamp

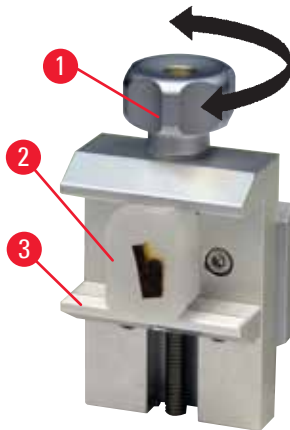

Fig. 48

The standard specimen clamp is available in two sizes: 40 x 40 mm and 50 x 55 mm. They are designed for direct clamping of rectangular blocks. In addition, they accommodate the foil clamp and V-insert.

- Turn the knurled screw (→ "Fig. 48-1") counterclockwise to move the movable jaw (→ "Fig. 48-3") downward.
- Mount the specimen (→ "Fig. 48-2") as required.
- Turn the knurled screw (→ "Fig. 48-1") clockwise to move the movable jaw upward against the fixed jaw to securely clamp the sample.



#### Warning

Insufficient frame conditions for sectioning.

**Specimen damage or poor sectioning results, for example, sections alternating in thickness, compressed, folded or stripped sections.**

- Do not continue sectioning if you recognize insufficient sections results.
- Make sure that all prerequisites for appropriate sectioning are met. Refer to the troubleshooting section of these Instructions for Use for further details.
- If you do not have sufficient knowledge in regards of troubleshooting insufficient sectioning results consult persons who do have that knowledge, for example, application experts of Leica Biosystems.

### 6.2.2 Universal cassette clamp

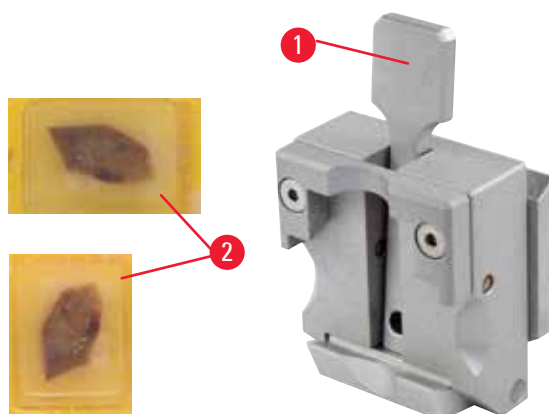

Fig. 49

Leica Biosystems cassettes with minimum dimensions of 39.8 x 28 mm and maximum dimensions of 40.9 x 28 mm may be clamped in the universal cassette clamp (UCC) horizontally as well as vertically.

- Pull the lever (→ "Fig. 49-1") towards the operator.
- Mount the cassette (→ "Fig. 49-2") horizontally or vertically as required.
- To clamp the cassette, release the lever (→ "Fig. 49-1").

**Warning**

Insufficient frame conditions for sectioning.

**Specimen damage or poor sectioning results, for example, sections alternating in thickness, compressed, folded or stripped sections.**

- Do not continue sectioning if you recognize insufficient sections results.
- Make sure that all prerequisites for appropriate sectioning are met. Refer to the troubleshooting section of these Instructions for Use for further details.
- If you do not have sufficient knowledge in regards of troubleshooting insufficient sectioning results consult persons who do have that knowledge, for example, application experts of Leica Biosystems.

**Warning**

The remaining broken edge of cassette lid may lead to poor section quality due to insecure clamping.

**Serious injury of persons.**

- When using a cassette whose lid is molded on, make sure that the broken edge left by removing the lid does not prevent the specimen from being securely clamped – if necessary, the specimen must be clamped horizontally.

**Caution**

When using thin-walled cassettes, the cassettes become deformed or insecurely clamped into place, or other problems because of the clamping system.

**Damage to specimen/Delayed diagnosis.**

- Be careful when using thin-walled-cassettes. Make sure that the thin-walled-cassettes are clamped securely in place.
- If the user tries clamping the cassette and realizes that it is not securely clamped into place, use a more stable one.

**Caution**

Paraffin deposits on the outside of the cassette can make the universal cassette clamp dirty.

**The dirt prevents the cassette from clamping in securely and can lead to sections being too thick or thin, chattering within the section and, in the worst-case scenario, damage to the specimen.**

- Prior to sectioning, the user has to verify that the specimen is clamped securely.
- Remove paraffin deposits from the universal cassette clamp.

### 6.2.3 Super cassette clamp

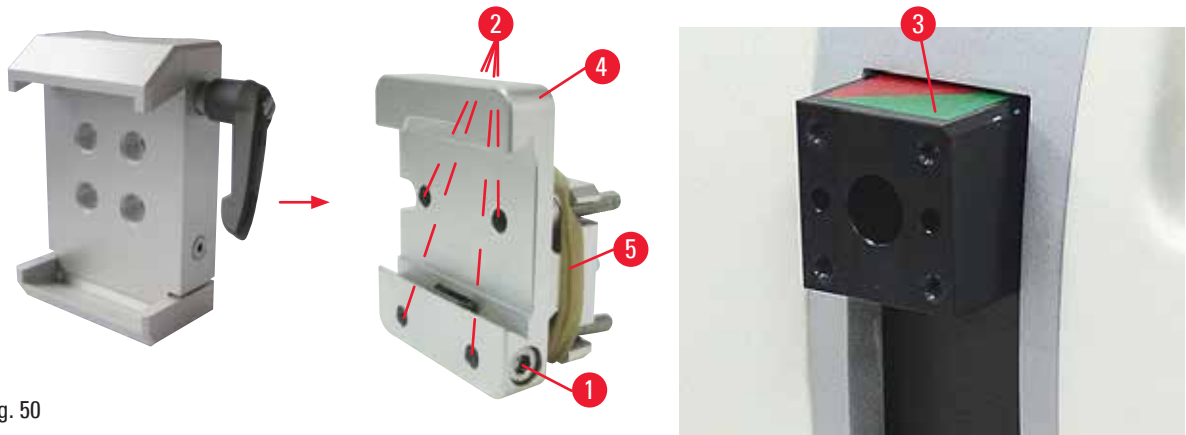

Fig. 50

#### Assembly of the super cassette clamp



#### Tips

Remove the rubber ring (→ "Fig. 50-5") only after having attached the rigid fixture for specimen clamps on the object head.

The super cassette clamp should preferably be used with the rigid fixture for specimen clamps.

To do so, proceed as follows:

- Screw the rigid fixture for specimen clamps (→ "Fig. 50-4") onto the object head (→ "Fig. 50-3"): Remove the screw (→ "Fig. 50-1"), place the rigid fixture for specimen clamps (→ "Fig. 50-4") onto the object head (→ "Fig. 50-3") from the front and tighten the screws (→ "Fig. 50-2") with a Hexagon key No. 3. Next, insert the screw (→ "Fig. 50-1") from the side and briefly tighten it with a Hexagon key No. 4.
- Insert the super cassette clamp from the side on the left into the dovetail guide of the rigid fixture for specimen clamps and tighten screw (→ "Fig. 50-1").



#### Caution

When using super cassette clamp, the orientation is not set to position "0" when directional fixture for specimen clamps is used with the rigid knife holder base, or the back-lighting illumination is attached.

**The instrument may malfunction leading to delayed diagnosis.**

- The orientation must be in position "0" and the cover for backlighting illumination must be detached.
- NEVER use the super cassette clamp with backlighting illumination.
- The force balance system has to be adjusted when using the super cassette clamp.

### 6.3 Knife holder base and knife holder



Fig. 51

The plastic handles of all clamping levers on the instrument and knife holders can be turned to the position that is most convenient for each user. Pull the grip (→ "Fig. 51-1") out of the lever, hold it in this position, and rotate it to the desired position. It will then lock automatically when released.

#### 6.3.1 Two-in-one blade holder E



Fig. 52

- |   |                       |   |                        |
|---|-----------------------|---|------------------------|
| 1 | Blade ejector         | 6 | Safety guard           |
| 2 | Clamping top          | 7 | Bolt                   |
| 3 | Clamping lever (left) | 8 | Clamping lever (right) |
| 4 | Segment arc           | 9 | Pressure plate         |
| 5 | Blade holder base     |   |                        |

The two-in-one blade holder optimized for use with Leica Biosystems disposable blades:

low-profile blades (L x H x W):

(80 +/-0.05) mm x (8 +/- 0.1) mm x (0.254 +/-0.008) mm;

high-profile blades (L x H x W):

(80 +/-0.05) mm x (14 +/-0.15) mm x (0.317 +/-0.005) mm.

The two-in-one blade holder E has a lateral displacement function, so that the entire width of the blade can be used. It is equipped with a blade ejector to safely remove the blade after use. The pressure plate is replaceable.



### Tips

The clamping levers on the two-in-one blade holder E are not interchangeable. The two clamping levers (→ "Fig. 52-8") (→ "Fig. 52-3") must remain in the position shown at all times, as otherwise isolated malfunctions of the two-in-one blade holder E can occur.

Clamping lever for the blade (→ "Fig. 52-8") is at the right, clamping lever for the lateral displacement (→ "Fig. 52-3") is at the left.

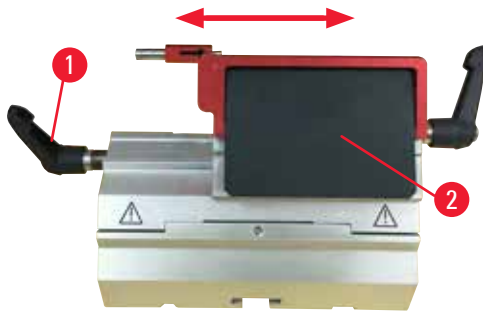

Fig. 53

### Lateral displacement

The lateral movement feature of the two-in-one blade holder E enables the use of the entire length of the blade by moving the clamping top laterally. Three predefined stop positions (left, center, right) that correspond to the width of a standard cassette may be used if desired.

- To release the clamping, rotate the lever (→ "Fig. 53-1") on the left side of the two-in-one blade holder E counterclockwise.
- Move the clamping-top (→ "Fig. 53-2") laterally.
- To clamp, rotate the lever (→ "Fig. 53-1") clockwise.



### Warning

Too thick or thin blade used in the two-in-one blade holder.

#### Sample impaired.

- Use a blade with a maximum thickness of less than 0.322mm and a minimum thickness of more than 0.246mm.
- The recommended compatible blade is listed in Optional Accessories (→ P. 62 – 6. Optional Accessories).



### Warning

The blade is not installed completely parallel to the upper edge of the pressure plate due to excess paraffin, uncleaned inserts, etc..

**When using the lateral movement function, failure to install the blade parallel to the pressure plate may result in poor sectioning results. For example, if a section is too thick or thin, chattering within the section, in the worst-case scenario, may damage the specimen.**

- Do not continue the sectioning when getting unsatisfying section results.
- Re-install the blade and make sure that it is parallel to the upper edge of the pressure plate.
- Always check the parallelism between the blade and pressure plate after moving the blade using the lateral movement function.
- Ensure there is no paraffin waste and the insert is clean before use.

### 6.3.2 Knife holder base, without lateral displacement feature



Fig. 54

#### Repositioning the knife holder base

The one-piece knife holder base (rigid) (→ "Fig. 54-2") can be moved forwards and backwards on the microtome base plate.

This vertical displacement allows bringing the knife holder into the optimal cutting position in relation to the specimen.

- To release, rotate the clamping lever (→ "Fig. 54-1") on the right side of the microtome base plate counterclockwise.
- Reposition the knife holder together with the knife holder base forward or backward as appropriate.
- Secure the clamping mechanism by rotating the lever (→ "Fig. 54-1") clockwise.

### 6.3.3 Knife holder E with a water trough for low-profile blades



Fig. 55

The knife holder E with a water trough (→ "Fig. 55") is only for low-profile blades with the blade dimensions (L x H x W):

$(80 \pm 0.05) \text{ mm} \times (8 \pm 0.1) \text{ mm} \times (0.254 \pm 0.008) \text{ mm}$ .

The safety guard on knife holder E consists of a red foldaway handle (→ "Fig. 55-1"). To cover the cutting edge, fold the safety guard handle (→ "Fig. 55-1") clockwise as illustrated in the figure.



#### Tips

The clamping levers on the knife holder are not interchangeable. The two clamping levers (→ "Fig. 55-2") and (→ "Fig. 55-3") must remain in the position shown at all times, as otherwise isolated malfunctions of the knife holder can occur.

Clamping lever for the blade (→ "Fig. 55-2") is at the right, clamping lever for the lateral displacement (→ "Fig. 55-3") is at the left.



Fig. 56

**Use**

Floating thin paraffin sections (for example, for subsequent immunostaining procedures) on the surface of the water.

The vessel is filled with distilled or deionized water up to the blade. After trimming, remove the section waste from the vessel and create the sections to be prepared.

The sections floating on the surface of the water can be collected using the glass slide.

**6.3.4 Knife holder N**

The knife holder N is appropriate for standard steel knives, profile c and d, up to 16 cm long. The integrated height adjustment feature allows you to also use knives that have been resharpened numerous times.

- Knife holder N (→ "Fig. 57"): For holding conventional knives up to 16 cm in length.

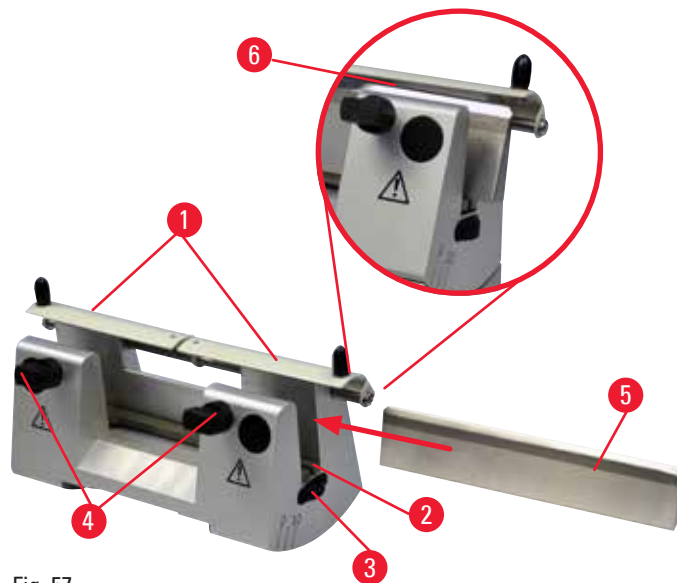

Fig. 57

**Mounting the knife support bar**

- Push the safety guard (→ "Fig. 57-1") to the center.
- Set the knife support bar (→ "Fig. 57-2") onto the height adjustment screws. The flat ends of the height adjustment screws must be located in the slots at each end of the knife support bar.





### Warning

The knife/blade is installed before the knife/blade holder and the knife/blade holder base are installed on the instrument.

#### **Serious injury of persons due to contact with extremely sharp knives and/or blades.**

- Prior to inserting the knife/blade, both the knife/blade holder and the knife/blade holder base must be installed on the microtome.

### Inserting the knife

- Rotate the knurled nuts (→ "Fig. 57-3") on the right and left of the knife holder forward in opposite directions, lowering the knife support bar to the lowest possible position, thus ensuring that the knife edge will not be damaged when inserting the knife.
- Unscrew the clamping screws (→ "Fig. 57-4") (rotate counterclockwise) until the knife can safely be inserted.
- Hold the knife (→ "Fig. 57-5") at the knife base and carefully insert it in the holder from the side as shown with the cutting edge facing upward.



Fig. 58

Either side of the profile c knife (→ "Fig. 58-1") can be inserted, whereas the facet of profile d knife (→ "Fig. 58-2") should face the operator. Putting the knife wrongly will damage the specimen and the knife.

### Knife height adjustment

When adjusting the knife height, the knife edge should be positioned as exactly as possible in the actual center of rotation of the knife holder. The lay-on edge (→ "Fig. 57-6") of the rear clamping chucks serves as a reference position for correct knife height adjustment.

- Rotate the knurled nuts (→ "Fig. 57-3") uniformly and backwards until the knife blade is parallel to the marks on the lay-on edges (→ "Fig. 57-6") of the rear clamping chucks.
- To clamp the knife (→ "Fig. 57-5") evenly screw the two knife clamping screws (→ "Fig. 57-4") inward (rotate clockwise).

### Lateral repositioning of the knife

- Push the safety guard (→ "Fig. 57-1") to the center.
- Loosen the clamping screws (→ "Fig. 57-4") by turning them counterclockwise.
- Push the knife (→ "Fig. 57-5") to the left or right as required.
- After the knife has been repositioned, adjust the knife height (→ P. 72 – Knife height adjustment), then tighten the clamping screw (→ "Fig. 57-4") which is located on the side to be turned clockwise to clamp the knife (→ "Fig. 57-5").



**Caution**

After the knife/blade holder is laterally displaced, the specimen is not retracted and retrimmed.

**Specimen damage.**

- Retract the object head and retrim the specimen block each time after laterally displacing the knife/blade holder.

**6.4 Section waste tray**

Fig. 59

The anti-static section waste tray offers ease of cleaning due to the anti-static surface.

Push the section waste tray (→ "Fig. 59-1") from the front to the microtome base plate (→ "Fig. 59-2") until it is held in place by the two magnets (→ "Fig. 59-3") (on the front of the microtome base plate).

**6.5 Backlighting****Tips**

The backlighting cannot be used with the blade holder base of the two-in-one blade holder E.

To use with backlighting on HistoCore MULTICUT, the External power supply unit Backlighting (Order No.: 14 0500 31244 ) must be ordered separately.

## 6 Optional Accessories

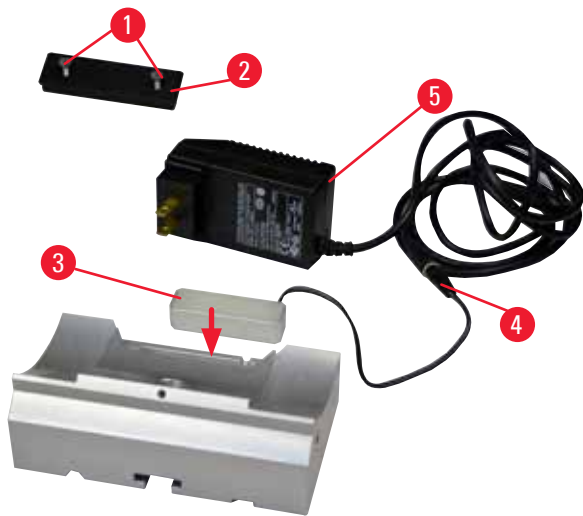

Fig. 60

- Remove the two screws (→ "Fig. 60-1") using a slotted screwdriver and then remove the cover plate (→ "Fig. 60-2").
- Insert the backlighting (→ "Fig. 60-3") in the recess at the rear of the knife holder base.
- Connect the plug (→ "Fig. 60-4") of the backlighting to the plug of the External power supply unit Backlighting (→ "Fig. 60-5").
- Select a proper plug which is in correct voltage and connect it with the adapter. Insert the plug into the power socket and the backlighting will be illuminated.



### Caution

When using super cassette clamp, the orientation is not set to position "0" when directional fixture for specimen clamps is used with the rigid knife holder base, or the back-lighting illumination is attached.

**The instrument may malfunction leading to delayed diagnosis.**

- The orientation must be in position "0" and the cover for backlighting illumination must be detached.
- NEVER use the super cassette clamp with backlighting illumination.
- The force balance system has to be adjusted when using the super cassette clamp.

### 6.6 Top tray



Fig. 61

The top tray is mounted on the hood of the microtome. The mark (→ "Fig. 61-1") on both the top tray and the hood helps to orient the installation of the top tray.

The top tray is for storage of the utensils used during sectioning as well as the sectioned specimens.

### 6.7 Universal microscope carrier



#### Tips

Unpack all accessories in the package and check for completeness.

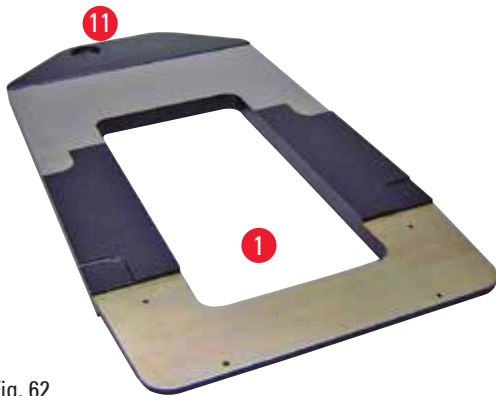

Fig. 62



Fig. 63

- (→ "Fig. 62-1"), Baseplate with drilling (→ "Fig. 62-11")
- (→ "Fig. 63-2"), Vertical column with size 8 cap screw (→ "Fig. 63-12") and lock washer (→ "Fig. 63-13")
- (→ "Fig. 63-3"), Horizontal arm with cross-member (→ "Fig. 63-14") and supporting ring (→ "Fig. 63-15")
- (→ "Fig. 63-4"), Support plate, large (for BIO-CUT, MULTICUT and AUTOCUT)
- (→ "Fig. 63-5"), Support plate, small (for NANOCUT R)
- (→ "Fig. 63-6"), Hexagon key No. 3
- (→ "Fig. 63-7"), 4 countersunk screws to install support plate
- (→ "Fig. 63-8"), Hexagon key size 8



Fig. 64

#### Assembling the universal microscope carrier

- Attach baseplate. Select the large (→ "Fig. 63-5") or small (→ "Fig. 63-4") support plate, depending on the microtome to be used. Attach the support plate to the baseplate with the included 4 countersunk screws (→ "Fig. 63-7") using the Hexagon key No. 3 (→ "Fig. 63-6").

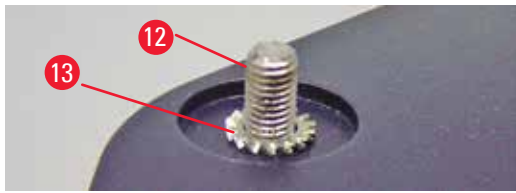

Fig. 65

- Attach vertical column. Insert the cap screw (→ "Fig. 65-12") into the hole of the baseplate from below. Place the lock washer (→ "Fig. 65-13") on the cap screw from above. Thread the silver vertical column (→ "Fig. 66-2") onto the baseplate from above and tighten with the Hexagon key size. 8.

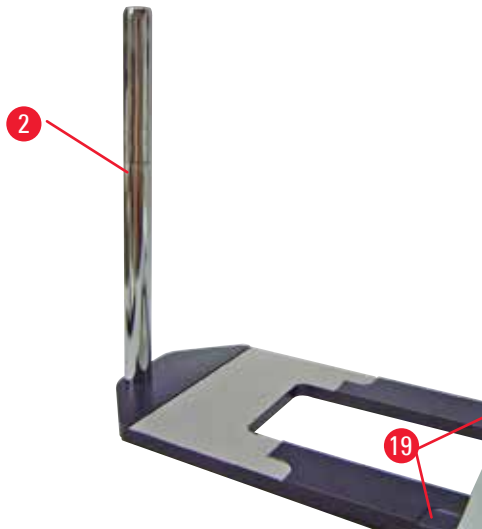

Fig. 66



### Warning

The universal microscope carrier tips.  
Serious injury of persons.

- After installing the vertical column, immediately place the microtome onto the baseplate so that the front feet of the microtome are positioned in the shallow recesses (→ "Fig. 66-19").



### Tips

The lock washer must be positioned between the baseplate and vertical column to prevent unintentional turning of the column.

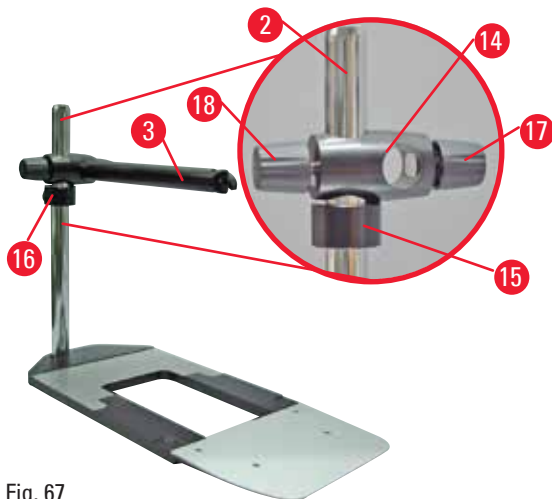

Fig. 67

- Attach horizontal arm. Slide the support ring (→ "Fig. 67-15") onto the vertical column and position it so that the lock nut (→ "Fig. 67-16") is facing to the back. Tighten the lock nut. Slide the cross-member (→ "Fig. 67-14") onto the column. Ensure that the lock screw (→ "Fig. 67-17") is facing to the right of the baseplate. The horizontal arm must be centered over the microscope. Slide the horizontal arm (→ "Fig. 67-3"), flat side facing the lock screw (→ "Fig. 67-17"), into the cross-member (→ "Fig. 67-14") and tighten.



### Tips

For more information on connecting and using the microscope, magnifying lens or cold-light source, please see the appropriate Instructions for Use.

## 6.8 Magnifying lens, LED illumination



### Tips

The magnifying lens provides a 2x magnification and can be used with all HistoCore series rotary microtomes.

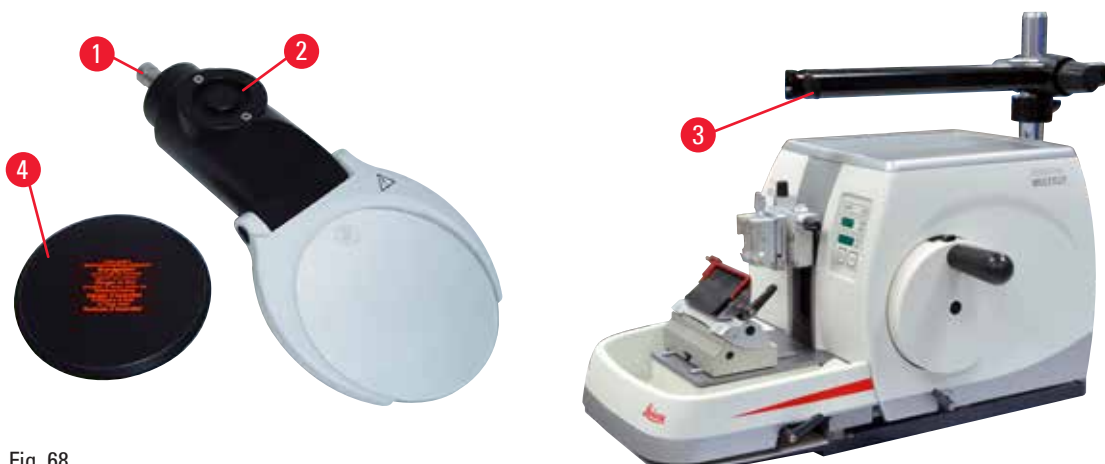

Fig. 68

- Open the screw (→ "Fig. 68-3") on the horizontal arm of the microscope carrier in a counterclockwise direction.
- Insert the silver connection piece (→ "Fig. 68-1") as far as it will go. Tighten the screw (→ "Fig. 68-3").
- The adapter (→ "Fig. 68-2") allows the LED Hi-power spots to be installed. Connect the LED 1000 Hi-Power spots, 2-arms, with the adapter (→ "Fig. 69"). Insert the plugs (→ "Fig. 69-1") of the LED 1000 Hi-Power spots, 2-arms, into the sockets (→ "Fig. 69-2") of the high-power spot controller (→ "Fig. 69-3"). Connect the power adapter (→ "Fig. 69-4") of the LED 1000 control unit to the high-power spot

controller, then connect to the power supply. Make sure to choose a correct plug from the provided ones (→ "Fig. 69-5") for the power adapter for your region.

- Press the button (→ "Fig. 69-7") on the high-power spot controller to turn on or turn off the two spot lights (→ "Fig. 69-6"), which is indicated correspondingly by two green lights (→ "Fig. 69-8") on the high-power spot controller. Turn the control wheel (→ "Fig. 69-9") to adjust the brightness of the spot lights.

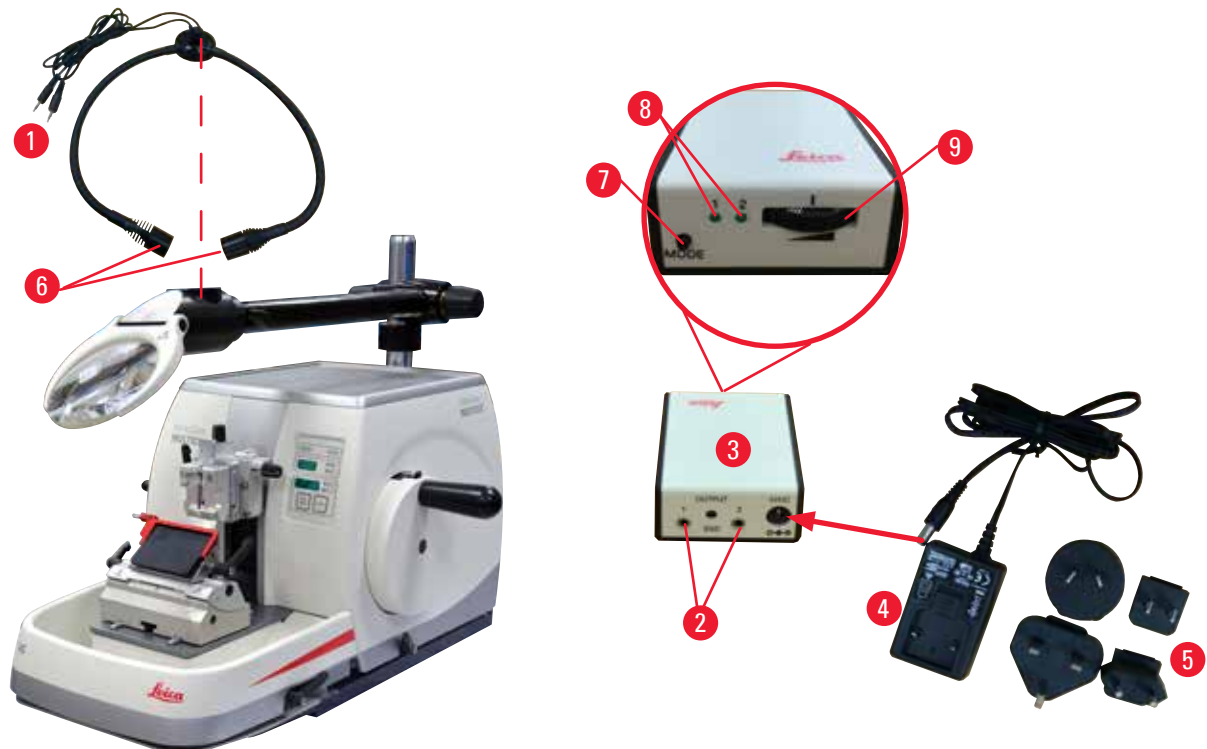

Fig. 69

- Adjust the position of the magnifying lens to the specimen being processed. The magnifying lens can be swiveled completely to the side if necessary.



### Warning

Magnifying lens is not covered when not working with it.

**Serious injury of persons and/or property damage due to burning glass effect. Magnifying lens can set surrounding objects on fire, especially when there is exposure to direct sunlight.**

- Always cover the magnifier lens when not working with it.
- Especially protect it from exposure to direct sunlight.

- Use the provided protective cap (→ "Fig. 68-4") to cover the magnifying lens.

## 6.9 Additional accessories

**Knife holder base, non-orientable**

Fig. 70

Silver for knife holder N and knife holder E with trough

- Order No.: 14 0502 37962

**Knife holder DH**

Fig. 71

The knife holder DH is for high-profile blades with the dimensions (L x H x W):  
(80 +/-0.05) mm x (14+0/-0.15) mm x (0.317+/-0.005) mm.

Blades with the thickness greater than 0.322 mm or with the height greater than 14 mm must not be used with the knife holder DH.

The knife holder DH/DL must be used with the knife holder base (Order No.: 14 0502 37962).

The knife holder DH/DL has a lateral displacement function, so that the entire width of the blade can be used. It is equipped with a blade ejector to safely remove the blade after use.

- Order No.: 14 0517 60829

**Knife holder DL**

Fig. 72

The knife holder DL is for low-profile blades with the dimensions (L x H x W):  
(80 +/-0.05) mm x (8 +0/-0.1) mm x (0.254 +/-0.008) mm

Blades with the thickness greater than 0.262 mm or with the height greater than 8 mm must not be used with the knife holder DL.

The knife holder DH/DL must be used with the knife holder base (Order No.: 14 0502 37962).

The knife holder DH/DL has a lateral displacement function, so that the entire width of the blade can be used. It is equipped with a blade ejector to safely remove the blade after use.

- Order No.: 14 0517 60830



**Knife holder kit DH**

Fig. 73

Includes Knife holder DH (14051760829) and Knife holder base (14050237962)

The knife holder DH is for high-profile blades with the dimensions (L x H x W):

(80 +/-0.05) mm x (14+0/-0.15) mm x (0.317+/-0.005) mm.

Blades with the thickness greater than 0.322 mm or with the height greater than 14 mm must not be used with the knife holder DH.

The knife holder DH/DL must be used with the knife holder base (Order No.: 14 0502 37962).

The knife holder DH/DL has a lateral displacement function, so that the entire width of the blade can be used. It is equipped with a blade ejector to safely remove the blade after use.

- Order No.: 14 0517 60887

**Knife holder kit DL**

Fig. 74

Includes Knife holder DL (14051760830) and Knife holder base (14050237962)

The knife holder DL is for low-profile blades with the dimensions (L x H x W):

(80 +/-0.05) mm x (8 +0/-0.1) mm x (0.254 +/-0.008) mm

Blades with the thickness greater than 0.262 mm or with the height greater than 8 mm must not be used with the knife holder DL.

The knife holder DH/DL must be used with the knife holder base (Order No.: 14 0502 37962).

The knife holder DH/DL has a lateral displacement function, so that the entire width of the blade can be used. It is equipped with a blade ejector to safely remove the blade after use.

- Order No.: 14 0517 60487

**Knife holder N**

Fig. 75

Silver, for holding conventional knives up to 16 cm in length

Height adjustment of the knife

Separate clearance angle adjustment

Movable safety guard

- Order No.: 14 0502 37993



**Knife holder E with trough**

Fig. 76

For low-profile disposable blades,  
dimensions (L x H x W):  
(80 +/-0.05) mm x (8 +/- 0.1) mm x (0.254 +/-0.008)  
mm, silver, with a water trough  
Quick clamp system with  
ability to shift the clamping top laterally  
3 click-stop positions make it easier to utilize the  
entire blade length  
Color-coded, foldaway safety guard

- Order No.: 14 0502 38961

**Blade holder base for two-in-one blade holder E**

Fig. 77

Blade holder base for two-in-one blade holder E

- Order No.: 14 0502 55546

**Two-in-one blade holder E**

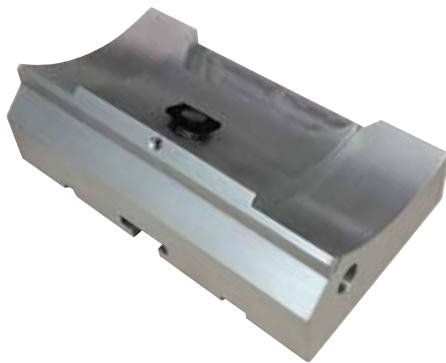
Fig. 78

For high and low profile disposable blades with  
the blade dimensions for low-profile blades (L x H  
x W):  
(80 +/-0.05) mm x (8 +/-0.1) mm x (0.254 +/-0.008)  
mm,  
and the blade dimensions for high-profile blades  
(L x H x W):  
(80 +/-0.05) mm x (14 +/-0.15) mm x (0.317 +/-  
0.005) mm.

For HistoCore MULTICUT

Ability to shift the clamping top laterally  
3 click-stop positions make it easier to utilize the  
entire blade length  
The pressure plate is replaceable.  
Color-coded, foldaway safety guard  
With blade ejector

- Order No.: 14 0502 54497

### Disposable blades — low profile (Leica 819)



Fig. 79

Dimensions (L x H x W): (80 +/-0.05) mm x (8 +/-0.1) mm x (0.254 +/-0.008) mm

- 01 package of 50 pcs.: 14 0358 38925
- 10 packages of 50 pcs.: 14 0358 38382

### Disposable blades — high-profile (Leica 818)



Fig. 80

Dimensions (L x H x W): (80 +/-0.05) mm x (14 +/-0.15) mm x (0.317 +/-0.005) mm

- 01 package of 50 pcs.: 14 0358 38926
- 10 packages of 50 pcs.: 14 0358 38383

### Knife 16 cm - profile c - steel, Knife 16 cm - profile d - steel

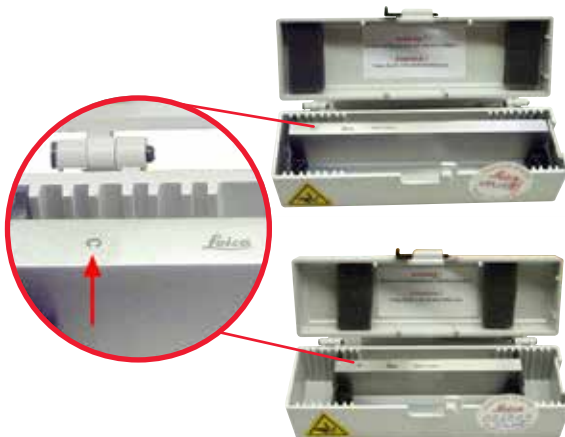

Fig. 81

Knife, 16 cm long, profile c  
Note: Knife case 14 0213 11140 included

- Order No.: 14 0216 07100

Knife, 16 cm long, profile d  
Note: Knife case 14 0213 11140 included

- Order No.: 14 0216 07132

**Knife case - small**

Fig. 82

Plastic, variable for 1 or 2 knives of 10 to 16 cm length.

- Order No.: 14 0213 11140

**Universal cassette clamp**

Fig. 83

with adapter, silver

For use with standard cassettes with dimensions that are 39.8 x 28 x 5.8 mm at minimum and 40.9 x 28.8 x 6.2 mm at maximum.

- Order No.: 14 0502 37999

**Standard specimen clamp**

Fig. 84

50 x 55 mm, with adapter, silver

- Order No.: 14 0502 38005

**Standard specimen clamp**

Fig. 85

40 x 40 mm, with adapter, silver

- Order No.: 14 0502 37998

**Specimen holder fixture, directional**

Fig. 86

Silver, including installation hardware.

Note: Quick clamping system 14 0502 37718 has to be ordered separately.

- Order No.: 14 0502 38949

**Specimen holder fixture, non-directional**

Fig. 87

Silver, for holding a variety of specimen clamps see ([→ P. 62 – 6. Optional Accessories](#)), including installation hardware

- Order No.: 14 0502 38160

**Specimen holder fixture, fine directional**

Fig. 88

Silver, with 2 zero point indicators, XY orientation 8° per direction, click stops every 2°

Note: Quick clamping system 14 0502 37718 must be ordered separately.

- Order No.: 14 0502 37717

**Quick clamping system**

Fig. 89

For specimen holder for use with the fine-directional fixture for specimen clamps with zero point indicators 14 0502 37717 or the directional fixture for specimen clamps 14 0502 38949

- Order No.: 14 0502 37718

**Super cassette clamp**

Fig. 90

With adapter, silver

Note:

Use only together with non-orientable specimen holder fixture 14 0502 38160, which has to be ordered separately.

Backlighting 14 0502 38719 cannot be used in connection with a Super cassette clamp.

We recommend use with Leica Biosystems Super cassettes and covers, white (VSP 59060B-BX, VSP 59060-CS) and Super metal embedding molds (VSP58166)

(LxWxH) 75 x 52 x 35 mm

- Order No.: 14 0502 38967

## Leica RM CoolClamp



Fig. 91

Electrically cooled universal cassette clamp with adapter for the HistoCore rotary microtomes. For use with standard cassettes with dimensions that are 39.8 x 28 mm at minimum and 40.9 x 28 mm at maximum.

Uniform microtome sections through electric cooling of the universal cassette clamp using the Leica RM CoolClamp.

Energy-saving cooling through the heat dissipation system.

The patented force balance system of the HistoCore rotary microtomes enables the specimen clamps to be changed quickly and reliably without modifying the handwheel.

Antistatic material makes cleaning easier. Can be retrofitted for all rotary microtomes from HistoCore series.

Technical data:

Precooling time until work begins: 30 minutes

Temperature: 20 K below ambient temperature

Ambient temperature range: +10 °C to +35 °C

Relative humidity: max. 80 %, non-condensing

Weight: approx. 650 g

Measurements (W x D x H): 80 x 114 x 204 mm

Power Inlet: 100 - 240 V/ 50/ 60 Hz

Certifications: CE, c\_CSA\_US

Standard delivery:

Leica RM CoolClamp

Power supply with cable and 4 adapters (UK, US, EU, AUS)

5 cable clamps

Instructions for Use and DVD

- Order No.: 14 0502 46573



## Tips

The Leica RM Coolclamp cannot be used in connection with a microscope or magnifier.

**Magnifier**

Fig. 92

For assembly on microscope carriers (14 0502 40580), 2x magnification

Note:

Magnifier includes an adapter for holding the optional LED illumination

- Order No.: 14 0502 42790

**Universal microscope carrier**

Fig. 93

Universal assembly

- Order No.: 14 0502 40580

**Backlighting**

Fig. 94

Note:

For HistoCore BIOCUT and MULTICUT only together with the External power supply unit Backlighting 14 0500 31244.

Backlighting cannot be used in connection with a Super cassette clamp 14 0502 38967.

- Order No.: 14 0502 38719

**External power supply unit Backlighting**

Fig. 95

For use with backlighting 14 0502 38719, for rotary microtome series HistoCore BIOCUT and MULTICUT

The following adapters are included:  
UK, Europe, USA/Japan, Australia

- Order No.: 14 0500 31244

**Top tray**

Fig. 96

For HistoCore rotary microtome series

- Order No.: 14 0517 56261

**Section waste tray**

Fig. 97

For HistoCore rotary microtome series

- Anti-static section waste tray  
Order No.:14 0517 56237



## Brush



Fig. 98

With magnet for blade removal tool for two-in-one blade holder E.

- Order No.: 14 0183 40426

## Safety gloves



Fig. 99

Size M, 250 ± 20mm, Yellow

- Order No.: 14 0340 29011

Cut resistant safety gloves, size S, 250±20mm

- Order No.: 14 0340 40859

## 6.10 Ordering information

Knife holder base	14 0502 37962
Knife holder N	14 0502 37993
Knife holder E w/trough low-profile	14 0502 38961
Blade holder base	14 0502 55546
2-in-1 blade holder E	14 0502 54497
Knife Holder DH	14 0517 60829
Knife Holder Kit DH	14 0517 60887
Knife Holder DL	14 0517 60830
Knife Holder Kit DL	14 0517 60487
Leica 819 disposable blades – low-profile (50/pack): (80 +/-0.05) mm x (8 +0/-0.1) mm x (0.254 +/-0.008) mm (L x H x W)	14 0358 38925
Leica 819 disposable blades – low-profile (50/pack)	14 0358 38382
Leica 818 disposable blades – high-profile (50/pack): (80 +/-0.05) mm x (14 +0/-0.15) mm x (0.317 +/-0.005) mm (L x H x W)	14 0358 38926





Leica 818 disposable blades – high-profile (50/pack)	14 0358 38383
Knife 16 cm - profile c - steel	14 0216 07100
Knife 16 cm - profile d - steel	14 0216 07132
Knife case - small	14 0213 11140
Universal cassette clamp	14 0502 37999
Standard specimen clamp 50x55 mm	14 0502 38005
Standard specimen clamp 40x40 mm	14 0502 37998
Directional fixture for specimen clamp	14 0502 38949
Rigid fixture for specimen clamp	14 0502 38160
Fine-directional fixture for specimen clamp	14 0502 37717
Quick clamping system	14 0502 37718
Super cassette clamp	14 0502 38967
Leica RM CoolClamp	14 0502 46573
Magnifier	14 0502 42790
Universal microscope carrier	14 0502 40580
LED 1000 Hi-Power spots, 2-arms (This module can only function with LED 1000 control unit, Order No.: 14 6000 04825.)	14 6000 04826
LED 1000 control unit (This module can only function with LED 1000 Hi-power spots, 2-arm, Order No.: 14 6000 04825.)	14 6000 04825
Backlighting (The backlighting can only be used with Knife holder base Order No.: 14 0502 37962.)	14 0502 38719
External power supply unit Backlighting	14 0500 31244
Top tray	14 0517 56261
Anti-static waste tray	14 0517 56237
Brush with magnet	14 0183 40426
Safety gloves, size M	14 0340 29011
Safety gloves, size S	14 0340 40859
Oil type, CONSTANT OY 46 K (50 ml)	14 0336 06086

For more consumables, please visit the product online catalog on our website  
[www.LeicaBiosystems.com](http://www.LeicaBiosystems.com).

## 7. Troubleshooting

### 7.1 Error codes

When an instrument error occurs, an error code appears on the three-digit LED display. The table below lists the error codes that may be displayed. Follow the instructions in the column of What to do.

Error Code	Instrument behavior	Error description	What to do
	Error code <b>E1</b> is displayed.	All setting values are changed back to the default values.	<ol style="list-style-type: none"> <li>1. Press any button on the control panel to confirm the error.</li> <li>2. Check all setting values to see if the previously entered values are still correct. The values may have to be reentered.</li> <li>3. If the error code <b>E1</b> appears repeatedly, call Leica Biosystems service.</li> </ol>
	Error code <b>E2</b> is displayed; a two-second-long warning beep is heard. The instrument does not respond to any operation.	Object head feeding driver may be in malfunction.	<ol style="list-style-type: none"> <li>1. Restart the instrument and check if error code <b>E2</b> still exists.</li> <li>2. If error code <b>E2</b> still exists, call Leica Biosystems service.</li> </ol>
	Error code <b>E3</b> is displayed; a two-second-long warning beep is heard. The instrument does not respond to any operation.	Object head feeding/retraction triggering may be in malfunction.	<ol style="list-style-type: none"> <li>1. Restart the instrument and check if error code <b>E3</b> still exists.</li> <li>2. If error code <b>E3</b> still exists, call Leica Biosystems service.</li> </ol>
	Error code <b>E4</b> is displayed; a two-second-long warning beep is heard. The instrument does not respond to any operation.	Object head feeding range may be in malfunction.	<ol style="list-style-type: none"> <li>1. Restart the instrument and check if error code <b>E4</b> still exists.</li> <li>2. If error code <b>E4</b> still exists, call Leica Biosystems service.</li> </ol>
	Error code <b>E5</b> is displayed; a two-second-long warning beep is heard. The instrument does not respond to any operation.	One Memory positioning may be in malfunction.	<ol style="list-style-type: none"> <li>1. Restart the instrument and check if error code <b>E5</b> still exists.</li> <li>2. If error code <b>E5</b> still exists, call Leica Biosystems service.</li> </ol>

## 7.2 Possible faults

Problem	Possible cause	Corrective action
<p><b>Thick/thin sections</b></p> <p>The sections alternate between being thick and thin, or there is chattering in the sections, or the specimen is torn out of the embedding. In extreme cases, there are no sections whatsoever.</p>	<ul style="list-style-type: none"> <li>• The blade, knife holder or orientation is not clamped properly.</li> <li>• The specimen is not clamped properly.</li> </ul>	<ul style="list-style-type: none"> <li>• Reclamp the blade, knife holders or orientation.</li> <li>• Check that the cassette is securely clamped in the universal cassette clamp.</li> <li>• If the universal cassette clamp is soiled by paraffin, clean the universal cassette clamp (→ P. 98 – 8.1 Cleaning the instrument).</li> <li>• When using cassettes whose lid is molded on, check that the broken edge allows the cassette to be clamped securely; if necessary, remove burrs or clamp the cassette into the universal cassette clamp horizontally instead of vertically.</li> <li>• If the cassette dimensions are within the specified tolerances and the cassette still cannot be securely clamped into place, it may be that the universal cassette clamp is configured incorrectly or is defective. In this case, have Technical Service inspect and reconfigure the universal cassette clamp.</li> </ul>

Problem	Possible cause	Corrective action
<p><b>(continued)</b>  <b>Thick/thin sections</b>                      The sections alternate between being thick and thin, or there is chattering in the sections, or the specimen is torn out of the embedding. In extreme cases, there are no sections whatsoever.</p>	<p>(continued)</p> <ul style="list-style-type: none"> <li>• The specimen is not clamped properly.</li> <li>• The blade is dull.</li> <li>• The pressure plate is damaged or incorrectly adjusted.</li> <li>• Clearance angle of the knife/blade too small.</li> <li>• Paraffin is not hard enough for the conditions.</li> <li>• Underfilled cassette.</li> <li>• Too thick or thin blade used in the two-in-one blade holder.</li> </ul>	<p>(continued)</p> <ul style="list-style-type: none"> <li>• When using cassettes, particularly thin-walled cassettes, from a company other than Leica Biosystems, the cassette may become deformed or other clamping problems may arise. If while trying to clamp the cassette you realize that it is not securely clamped into place, an alternative tensioning clamp must be used.</li> <li>• Laterally displace the knife/blade holder, or insert a new knife/blade.</li> <li>• Insert a new pressure plate or use a new two-in-one blade holder E.</li> <li>• Readjust the pressure plate.</li> <li>• Systematically try several clearance angle adjustments, until the optimum angle is found.</li> <li>• Use higher melting point paraffin or cool the block.</li> <li>• Ensure the cassette is properly filled, and the front block is firmly fastened to the cassette body.</li> <li>• The recommended compatible blade is listed in <a href="#">Optional Accessories (→ P. 62 – 6. Optional Accessories)</a>.</li> </ul>
<p><b>Section compression</b>                      The sections are so compressed and squeezed together, with folds and no ribbons formed.</p>	<ul style="list-style-type: none"> <li>• The blade is dull.</li> <li>• The specimen is too warm.</li> <li>• The sectioning speed is too fast.</li> </ul>	<ul style="list-style-type: none"> <li>• Use another area of the blade or a new blade.</li> <li>• Cool the specimen before sectioning.</li> <li>• Reduce the sectioning speed.</li> </ul>

Problem	Possible cause	Corrective action
<b>"Stripes" in sections</b> For the two-in-one blade holder E	<ul style="list-style-type: none"> <li>Paraffin accumulated on the rear side of the blade and the rear pressure plate of the knife holder.</li> <li>The clearance angle is too steep, as close to zero degree.</li> <li>The blade has nicks in the cutting edge.</li> </ul>	<ul style="list-style-type: none"> <li>Remove paraffin from these areas regularly.</li> <li>Adjust the clearance angle.</li> <li>Exchange the blade.</li> </ul>
<b>Noises during sectioning</b> The knife "sings" when sectioning hard specimens. The sections show scratches or chatter marks.	<ul style="list-style-type: none"> <li>The sectioning speed is too fast.</li> <li>The clearance angle is too wide.</li> <li>Insufficient clamping of specimen and/or knife holder.</li> <li>Retraction is switched off during sectioning of resin / plastic embedded specimens.</li> </ul>	<ul style="list-style-type: none"> <li>Select a slower sectioning speed.</li> <li>Systematically decrease the clearance angle until the optimum adjustment is obtained.</li> <li>Check all screw and clamp connections on the specimen holder system and the knife holder. If necessary, tighten the levers and screws.</li> <li>Switch on retraction.</li> </ul>
<b>High blade consumption</b>	<ul style="list-style-type: none"> <li>Too great of a sectioning force was applied.</li> <li>Too sharp clearance angle.</li> </ul>	<ul style="list-style-type: none"> <li>Adjust the sectioning speed and/or section thickness when trimming. Select a smaller section thickness, rotate the handwheel more slowly.</li> <li>Adjust the clearance angle.</li> </ul>

### 7.3 Instrument malfunctions

The following is a list of the most common problems which can arise while working with the instrument, along with possible causes and troubleshooting procedures. If the malfunction cannot be remedied with any of the options listed in the table, or the problem occurs repeatedly, inform Leica Biosystems Service Support immediately.

Problem	Possible cause	Corrective action
<b>No display; no reaction to buttons pressed after the instrument is switched on.</b>	<ul style="list-style-type: none"> <li>• The power cable is not connected correctly.</li> <li>• Power fuses are defective.</li> <li>• The cable of the control panel is not connected correctly.</li> <li>• The voltage selection switch is set incorrectly.</li> </ul>	<ul style="list-style-type: none"> <li>• Check the connection of the power cable.</li> <li>• Replace power fuses.</li> <li>• Check the connection of the cable to the control panel.</li> <li>• Check the voltage setting and correct it if necessary (→ <a href="#">P. 36 – 4.5.1 Checking the voltage</a>).</li> </ul>
<b>Feed motion no longer occurs.</b>	<ul style="list-style-type: none"> <li>• The end of the residual path has been reached.</li> <li>• The specimen was already within the residual path when the instrument was switched on.</li> </ul>	<ul style="list-style-type: none"> <li>• Select the trimming mode by pressing <b>TRIM/SECT</b>. Then retract the specimen using the coarse feed button.</li> <li>• See above.</li> </ul>
<b>The specimen in the residual path area cannot be returned using the coarse feed buttons.</b>	<ul style="list-style-type: none"> <li>• STEP mode is still active (LED in <b>SECT</b> button lights up).</li> </ul>	<ul style="list-style-type: none"> <li>• Press the <b>TRIM/SECT</b> button to switch to the trimming mode. Return the specimen using the coarse feed button.</li> </ul>

## 7.4 Malfunctions of the two-in-one blade holder E

### 7.4.1 Replacing the pressure plate

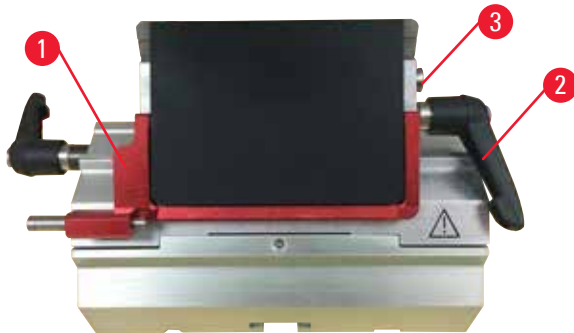

Fig. 100

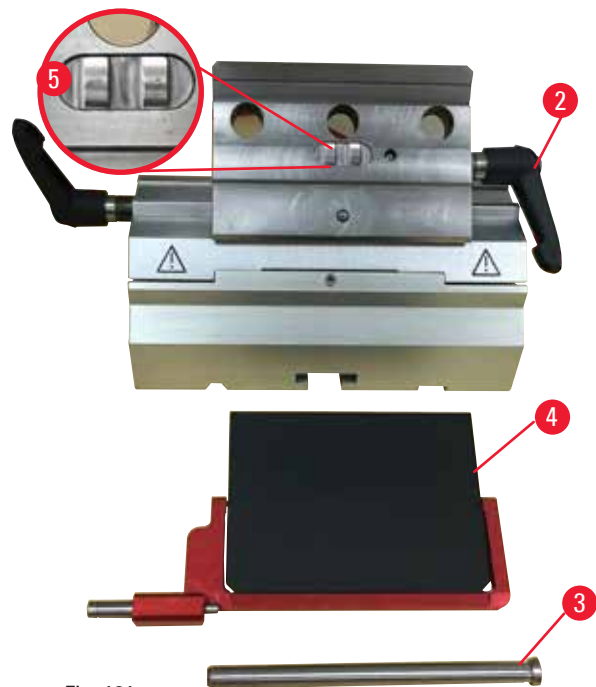

Fig. 101

1. Bring the safety guard down (→ "Fig. 100-1").
2. Rotate the clamping lever counterclockwise (→ "Fig. 100-2").
3. Pull out the bolt (→ "Fig. 100-3") (→ "Fig. 101-3").
4. Remove the damaged pressure plate (→ "Fig. 101-4").



#### Tips

Make sure that the insert of the clamping top is installed as shown (→ "Fig. 101-5") in case it falls out. If it is installed wrongly, the pressure plate cannot be clamped.

5. Install a new pressure plate.
6. Insert the bolt (→ "Fig. 101-3").
7. Rotate clamping lever clockwise (→ "Fig. 101-2").



### 7.4.2 Mounting the clamping top onto the segment arc



Fig. 102

To ensure a proper sectioning result, the clamping top (→ "Fig. 102-2") must be securely clamped onto the segment arc (→ "Fig. 102-4").

The clamping is carried out using an eccentric lever (→ "Fig. 102-3"). The clamping force is adjusted with the setscrew (→ "Fig. 102-1") on the underside of the segment arc. The setting of the clamping is carried out so that the clamping lever can be rotated to the stop with constantly increasing resistance. Adjust the clamping with a 2.5 mm Hexagon key at the setscrew (→ "Fig. 102-1") so that the lever initially "slips" when the lever is activated. Continue turning the setscrew (→ "Fig. 102-1") a little bit (approx. 1/4 turn to the left or right) then check that the lever no longer "slips", but also does not jam "heavily".

### 7.5 The setting of the clamping system of the clamp mount on the base plate

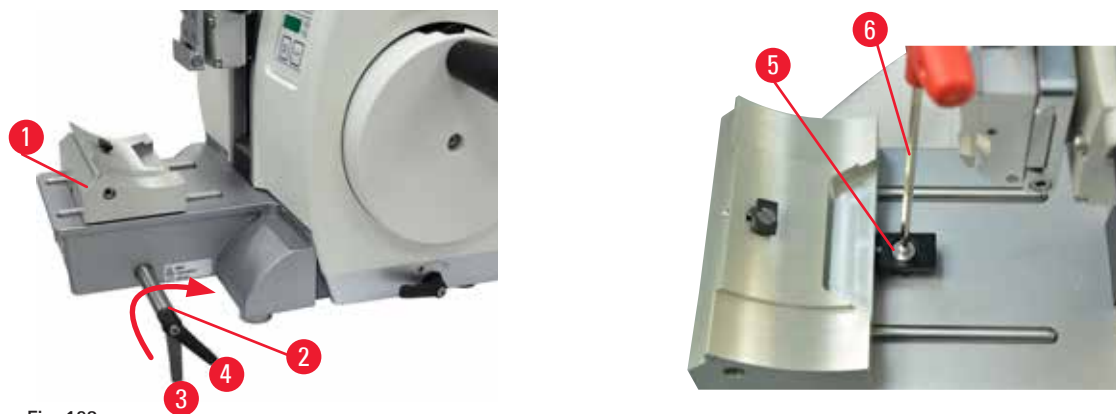

Fig. 103

To set the clamping distance from the eccentric bolt to 270 °, do the following steps.

1. Place the blade holder base (→ "Fig. 103-1") on the instrument base.
2. Adjust by screwing or unscrewing the countersunk screw (→ "Fig. 103-5") in the clamping piece in the base using the Hexagon key No. 4 (→ "Fig. 103-6"), so that the eccentric bolt (→ "Fig. 103-2") can be clamped at 0° position (→ "Fig. 103-3") and 270° position (→ "Fig. 103-4").

### 8. Cleaning and Maintenance

#### 8.1 Cleaning the instrument



##### Warning

Cleaning the instrument without unplugging the power plug.

##### **Electrical shock which causes injury of persons.**

- Before each cleaning, switch off the instrument and disconnect the power plug from the mains. Spray proper solvents or cleaners on a cleaning pad and not directly on the instrument to prevent liquids from entering. If liquids go into interior of instrument, contact Leica Biosystems service.



##### Warning

The liquids go into the interior of the instrument.

##### **Serious injury of instrument/persons, or specimen damage.**

- Ensure that liquids do not enter the interior of the instrument during operation and maintenance.



##### Warning

Knife/blade was not removed when knife/blade holder was uninstalled from the microtome.

##### **Serious injury of persons due to contact with extremely sharp knife/blade.**

- Before uninstalling the knife/blade holder from the microtome always make sure to detach the knife/blade wearing cut-resistant gloves and store the knife/blade in a safe place.



##### Warning

Knife/blade stored in inappropriate manner.

##### **Serious injury of persons, for example, due to unexpected fall off.**

- Always store knife/blade in an appropriate place when not using them, for example, store it in the dedicated knife case.
- Never place a knife anywhere with the cutting edge facing upwards and never try to catch a falling knife.



##### Warning

Knife/blade holder falling off the instrument.

##### **Serious injury of persons and/or property damage.**

- If the knife/blade holder is not fixed, for example, during installation or cleaning, pay special attention that the knife/blade holder is not falling off.
- Whenever possible, fix the knife/blade holder to avoid falling off.
- For installation or maintenance purposes remove the knife/blade holder from the knife holder base to avoid accidental falling off.

**Caution**

Use of improper solvents or cleaners, or sharp/hard tools to clean the instrument or accessories.

**Potential instrument malfunction or delay of diagnosis.**

- Do not use any solvents containing acetone or xylene for cleaning.
- When using cleaners, please comply with the safety instructions of the manufacturer and the laboratory safety regulations.
- Never use a sharp or hard tool to scrape the instrument surface.
- Never soak the accessories in any cleaning solvent or water.
- Clean steel knives using an alcohol-based solution or acetone.
- For cleaning and removal of paraffin, do not use xylene or cleaning fluids containing alcohol (for example glass cleaner).

**Note**

Accessories and components experience corrosion due to using corrosive/strongly acidic/alkaline reagent or solvent with the instrument or accessories, such as decalcified solution that contains acid, ammonium hydroxide that contains alkali, etc.

**Accessories can malfunction.**

- Avoid corrosive/strongly acidic/alkaline reagent or solvent dripping onto the instrument surface or accessories.
- If such reagent or solvent has dripped onto the instrument surface or accessories, wipe off the residue and dry the accessories sufficiently as soon as possible.
- If such reagent or solvent is used frequently, carry out a thorough daily cleaning of the blade holder, the universal cassette clamp (UCC), and other accessories if necessary.

Before each cleaning, carry out the following preparatory steps:

- Raise the specimen clamp to the upper end position and activate the handwheel lock.
- Switch the instrument off and unplug it.
- Remove the blade from the blade holder and insert it in the receptacle at the bottom of the dispenser, or remove the knife from the knife holder and put it back in the knife case.
- Remove knife/blade holder base and knife/blade holder for cleaning.
- Remove the specimen from the specimen clamp.
- Remove section waste with a dry brush.
- Remove specimen clamp and clean separately.

**Instrument and outside surfaces**

If necessary, the varnished outside surfaces of the control panels can be cleaned with a mild commercial household cleaner or soap water and then be wiped with a cloth.

To remove paraffin residue, xylene substitutes, paraffin oil, or paraffin removers can be used. The instrument must be completely dry before it can be used again.

**Warning**

Wiping the knife in the wrong direction during cleaning.

**Serious injury of persons.**

- Always wipe the knife from the back of the knife to the cutting edge.



## Tip

Do not turn the instrument on before it is completely dry.

## Two-in-one blade holder E



Fig. 104

1. Remove the insert (→ "Fig. 104-9") for low-profile blades.
2. Remove the pressure plate first (→ "Fig. 104-4") from the clamping top. To do so, rotate the blade clamping lever (→ "Fig. 104-6") counterclockwise and pull it out sideways; pull out the bolt (→ "Fig. 104-7") and take the pressure plate off.
3. Remove the clamping top. To do so, rotate the clamping lever (→ "Fig. 104-2") of the lateral displacement counterclockwise and pull it out sideways; push the clamping top (→ "Fig. 104-3") until it can be removed from the segment arc (→ "Fig. 104-5").
4. Loosen the eccentric bolt using Hexagon key No. 4 and remove the segment arc from the blade holder base.
5. Clean all parts of the two-in-one blade holder E.



## Caution

During cleaning, the parts of blade holders are mixed up.

**Poor section quality.**

- Do not mix up blade holders during cleaning.

- Lay the removed parts on an absorbent cloth into the drying chamber (up to a max. of 65 °C) and let the paraffin contamination run off.



**Warning**

Removing the parts from the drying chamber (65 °C) during cleaning of the knife/blade holder.  
**Scalding hazard.**

- Wear heat insulating gloves when removing the parts from the drying chamber (65 °C).

- Wipe the two-in-one blade holder E and allow to cool down to room temperature, then reassemble it.
- After cleaning the moving parts of the two-in-one blade holder E, apply a thin coat of drive part oil to them.
- When installing the pressure plate (→ "Fig. 104-4"), ensure that the insert of the clamping top is installed correctly as shown (→ "Fig. 104-8") and the upper edge of the pressure plate is parallel to and level with the rear edge of the clamping top (→ "Fig. 104-3").



**Tips**

If the insert of the clamping top is installed incorrectly, the pressure plate cannot be clamped.

**Universal cassette clamp**

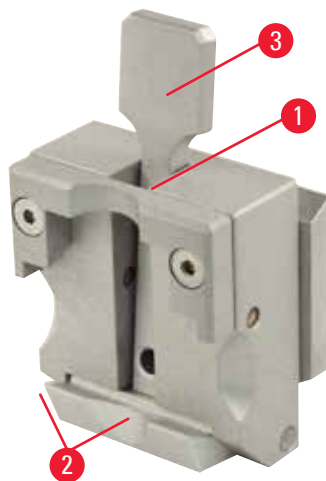

Fig. 105

- Detach cassette clamp (→ "Fig. 105-1") for a thorough cleaning, removing all paraffin residues.
- For cleaning, do not use xylene. Use xylene substitutes or paraffin removers.
- The cassette clamp (→ "Fig. 105-1") can also be placed in an oven heated to a maximum of 65 °C, until the liquid paraffin escapes.
- Remove paraffin residues with a dry cloth.
- After such a cleaning procedure in an oven, always be sure to lubricate the spiral springs (→ "Fig. 105-2") of the tension lever (→ "Fig. 105-3"). Allow the cassette clamp to cool down before mounting it back to the instrument.

**8.2 Maintenance**

**8.2.1 Replacing fuses**



**Warning**

Replacing the fuses without switching off the instrument and unplugging the power plug.

**Electrical shock which causes injury of persons.**

- Turn the instrument off with the power switch and disconnect the power plug from the mains before replacing the fuses.



### Caution

Using the wrong fuses which are not with the same specification defined in the section of Technical data in the Instructions for Use.

#### Delayed diagnosis because the instrument does not work using wrong fuses.

- Only use fuses of the same specification defined in the section of Technical data in the Instructions for Use.

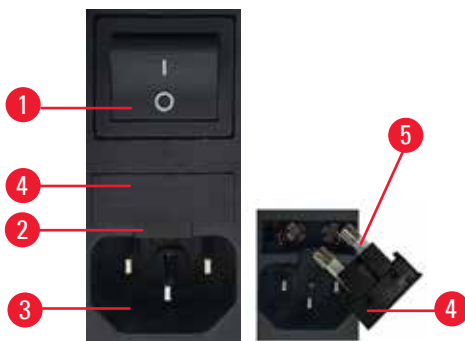

Fig. 106

- Make sure the main switch (→ "Fig. 106-1") is off.
- Insert a small screwdriver into the cutout (→ "Fig. 106-2") above the power supply (→ "Fig. 106-3") and carefully pry out the insert.
- Remove the fuse housing (→ "Fig. 106-4") together with the fuses (→ "Fig. 106-5").
- Replace defective fuses with new fuses.
- Reinsert the fuse housing into the instrument and push it until it engages (audible click).

### 8.3 Maintenance instructions



### Tips

Only authorized and qualified service personnel may access the internal components of the instrument for service and repair.

The instrument is basically maintenance-free.

To ensure trouble-free operation of the instrument over a long period of time, the following is recommended by Leica Biosystems:

1. Thoroughly clean the instrument on a daily basis.
2. Enter into a service contract at the latest at the end of the warranty period. For more information, please contact your local Leica Biosystems technical service center.
3. Have the instrument inspected on a regular basis by a qualified service technician authorized by Leica Biosystems. The intervals depend on how heavily the instrument is used.

We recommend the following inspection intervals depending on the general workload of the instrument as defined in the two categories listed in the table:

	Category I	Category II
Number of sections per day:	> 8,000 sections per day	< 8,000 sections per day
Workload (hours per day):	> 5 hours per day	≤ 5 hours per day
Sectioning speed:	Predominantly high sectioning speed	Slow to medium sectioning speed
Specimen material:	Working with soft and hard specimens	Predominantly soft specimen material
Maintenance:	Every 12 months	Every 24 months



Fig. 107

**Note for inspection**

When the instrument reaches approx. 2 million performed strokes, the code **SEr** always appears for approx. 3 seconds in the three-digit display when the **TRIM/SECT** button is pressed (switching between trimming and sectioning mode).

This is a reminder that the instrument must be inspected by an authorized Leica Biosystems service technician, regardless of how heavily the instrument has been used.

**8.4 Lubricating the instrument**

Once a month, lubricate the following parts with the included drive parts oil (1 - 2 drops are enough).

**Warning**

Oil is spilled and not cleaned-up immediately.

**Serious injury of persons, for example, by slipping and getting in contact with dangerous parts like the knife/blade of the instrument.**

- Always make sure that no oil is spilled.
- If oil has been spilled, clean it up immediately, thoroughly and completely.

**Instrument**

Fig. 108

- Guide rails (→ "Fig. 108-1") for the knife holder base on the microtome base plate.
- The T-piece (→ "Fig. 108-2") on the microtome base plate.

### Two-in-one blade holder E



Fig. 109

- Clamping lever (→ "Fig. 109-1") for the lateral displacement.
- Clamping lever (→ "Fig. 109-2") for the blade.

### Universal cassette clamp

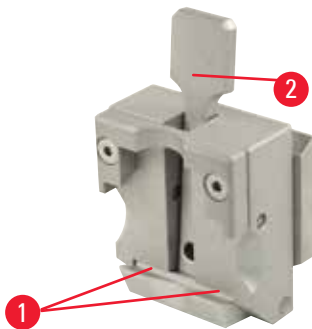

Fig. 110

Lubricate the spiral springs (→ "Fig. 110-1") of the tension lever (→ "Fig. 110-2") and move it back and forth several times.



---

## **9. Warranty and Service**

### **9.1 Warranty**

Leica Biosystems Nussloch GmbH guarantees that the contractual product delivered has been subjected to a comprehensive quality control procedure based on the Leica Biosystems in-house testing standards, and that the product is faultless and complies with all technical specifications and/or agreed characteristics warranted.

The scope of the warranty is based on the content of the concluded agreement. The warranty terms of your Leica Biosystems sales organization or the organization from which you have purchased the contractual product shall apply exclusively.

### **9.2 Service information**

If you are in need of technical customer support or spare parts, please contact your Leica Biosystems representative or the Leica Biosystems dealer where you purchased the instrument.

Please provide the following information:

- Model name and serial number of the instrument.
- Location of the instrument and name of a contact person.
- Reason for the service call.
- The date of delivery.

### **9.3 Decommissioning and disposal**

The instrument or parts of the instrument must be disposed of according to existing applicable, local regulations.

**10. Decontamination Confirmation**

Every product that is returned to Leica Biosystems or that requires on-site maintenance must be properly cleaned and decontaminated. Please find the dedicated template for confirming decontamination by using the search function on our website at [www.LeicaBiosystems.com](http://www.LeicaBiosystems.com). This template has to be used for gathering all required data.

When returning a product, a copy of the filled and signed confirmation has to be enclosed or passed on to the service technician. The responsibility for products that are sent back without this confirmation or with an incomplete confirmation lies with the sender. Returned goods that are considered to be a potential source of danger by the company will be sent back at the expense and risk of the sender.



www.LeicaBiosystems.com



Version 1.9, Revision M - 07.2024

Leica Biosystems Nussloch GmbH  
Heidelberger Strasse 17 - 19  
D-69226 Nussloch  
Germany

Tel.: +49 - (0) 6224 - 143 0  
Fax: +49 - (0) 6224 - 143 268  
Web: www.LeicaBiosystems.com

